

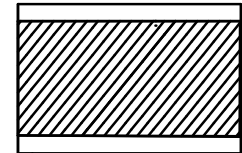

SEE THE MiTek TRUSS DESIGN  
REFERENCING THIS DETAIL  
FOR ADDITIONAL DESIGN INFORMATION

9" to 21"  
PRE-FABRICATED  
WOOD "I - JOIST "  
PLATED IN PLANE OF TRUSS

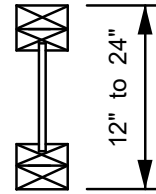
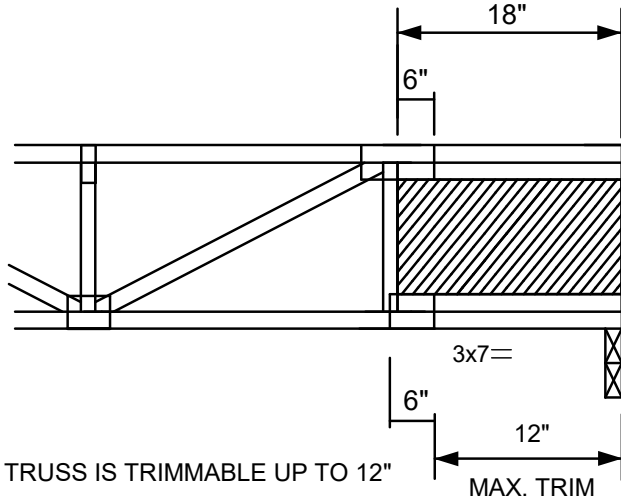

TRUSS IS TRIMMABLE UP TO 12"  
MINIMUM BEARING SIZE IS 1-3/4"  
MAX REACTION = 1320 lbs

WOOD "I - JOIST " MINIMUM REQUIREMENTS		
FLANGE TO MATCH TRUSS CHORD SIZE		
1-3/4" REACTION LIMIT WITHOUT WEB STIFFENER MUST BE = TO OR > THAN REACTIONS SHOWN		
FLANGE Ft	3x2 = 736 psi	4x2 = 509 psi