

SEE THE MITek TRUSS DESIGN
REFERENCING THIS DETAIL
FOR ADDITIONAL DESIGN INFORMATION

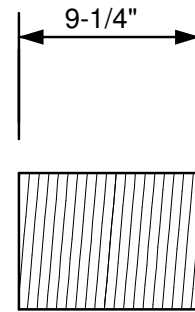
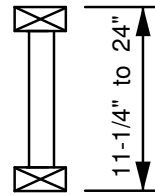
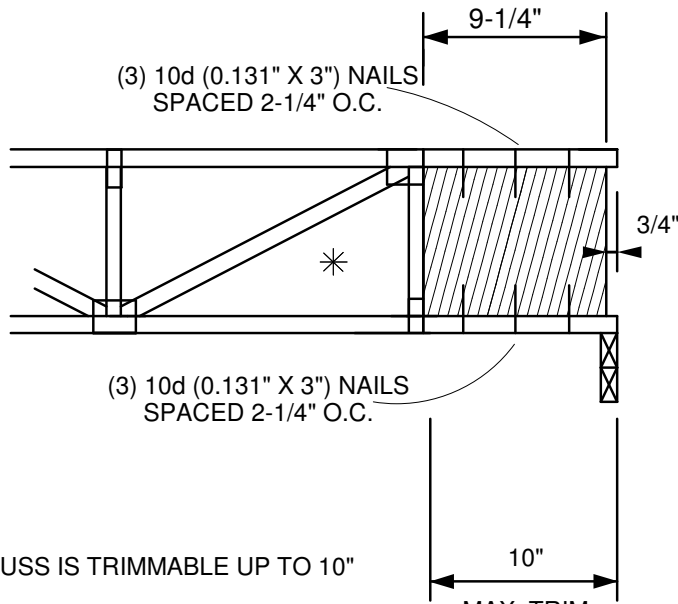

2x10 VERTICAL BLOCK
No.2 : SPF, SP, DF or HF

TRUSS IS TRIMMABLE UP TO 10"
MAXIMUM REACTION= 1200 lbs
MINIMUM BEARING SIZE IS 1-3/4"

* LAST DIAGONAL WEB MUST BE RAN UP TO THE TOP CHORD AS SHOWN