

JUS28 - TOP VIEW

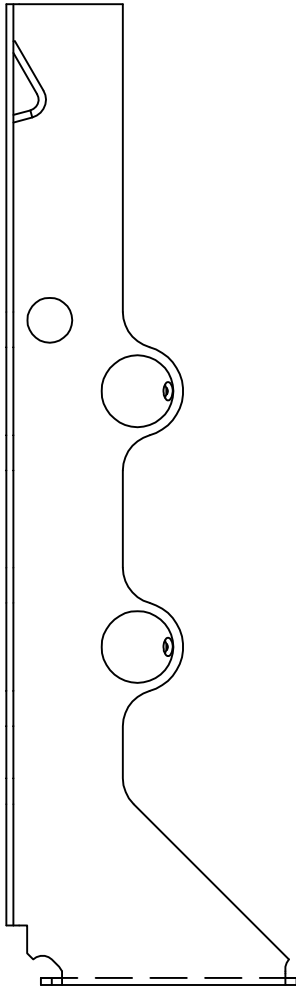

JUS28 - SIDE VIEW

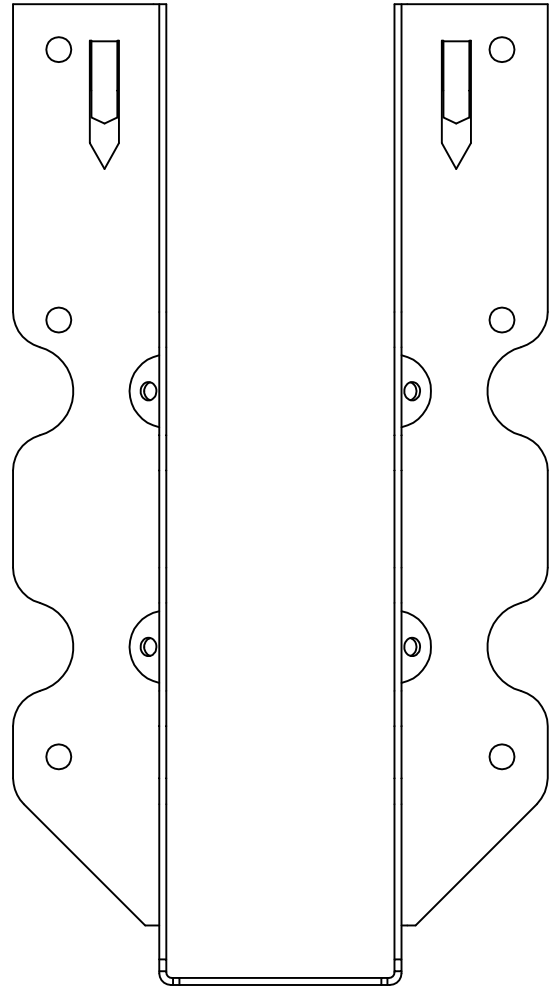

JUS28 - FRONT VIEW