

# FWH Fire Wall Hanger Installation Instructions

- Place the FWH hanger on top of the wall (or header) with the flanges tight to the face of the framing. Nail into place with the specified fasteners.

U.S. Patent No. 10,316,510,  
U.S. Patent No. 11,021,867 B2,  
U.S. Patent No. 11,649,626 B2

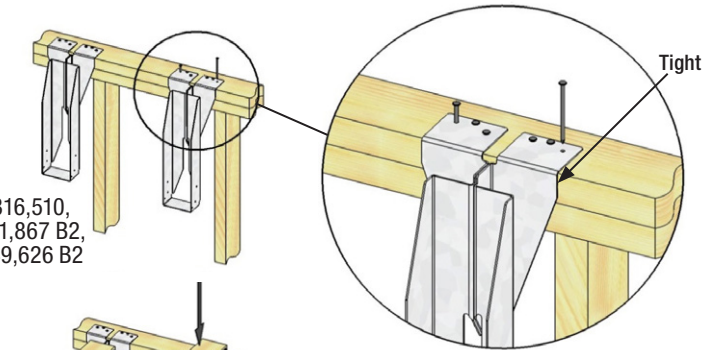

- Drop the trusses into place. The gap between the end of the truss and the top of the FWH hanger should be 1/8" or less.

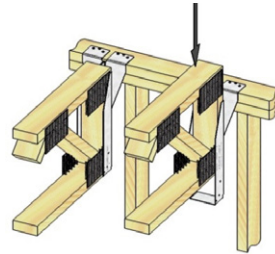

- Tap the bottom of the FWH hanger until it is tight to the end of the floor truss. There should be a minimum gap of 1-7/16" between the back of the FWH hanger and the face of the stud wall.

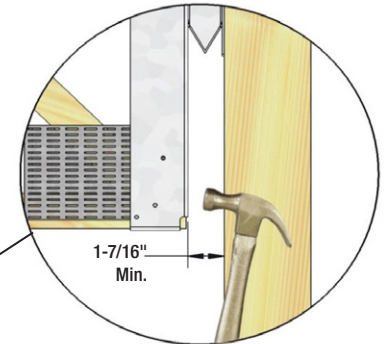
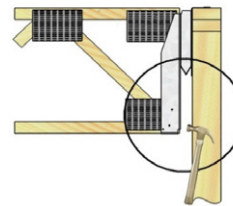

**NOTE:** A gap greater than 1-7/16" is preferable and does not decrease the load carrying capacity of the hanger. A larger gap makes the installation of the gypsum board easier.

- Nail the FWH hanger to the truss using the specified fasteners.

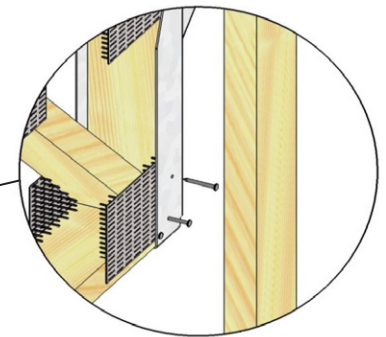
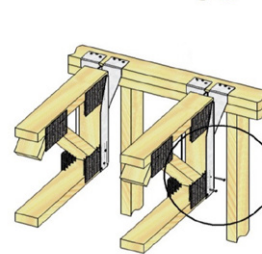

- Mark the location of the FWH hangers and cut an 8" slot in the gypsum board using MiTek's FHW-T Fire Wall Template, drywall cut-out tool and spiral cutting bit.

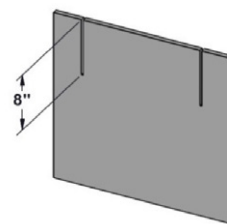

- Swing the gypsum board into place behind the FWH hanger and fasten to wall framing.

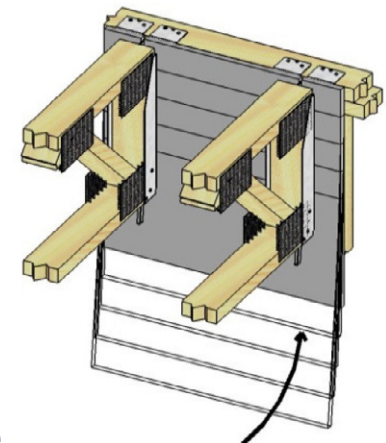
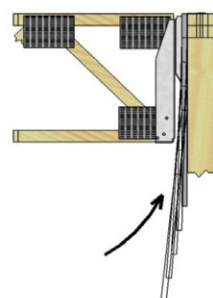

### Customer Service & Technical Assistance

Phone: 1-800-328-5934 • Fax: 1-952-898-8605 • Email: [customerservice@mii.com](mailto:customerservice@mii.com)