

Service Bulletin

Machinery Affected: BLADE wood processing system
Document: SB207
Title: Replacing the Saw Blade Hub and Bushing
Applies To: All
Distribution: All BLADE Customers as of July 2014 & Upon Order



Copyright © 2014 MiTek®. All rights reserved.

MiTek Machinery Division
301 Fountain Lakes Industrial Drive
St. Charles, MO 63301
Phone: 800-523-3380
www.mii.com

Item # and Rev.	SB207
Date Created	28 Aug. 2014
Created By	R. Tucker
Reviewed by	M. Kanjee
Approved by	M. Kanjee
Revision Date	
Revised By	
Approved By	
Applicability	all
Effectivity	all

Purpose and Scope

This document describes how to safely replace the saw blade hub and bushing on the equipment listed on the title page. Read and follow these steps any time the saw blade hub and/or bushing is replaced.

Overview

The parts included in this kit are shown in Table 1. Please ensure all parts are present before starting this procedure.

Table 1: Parts in SB207KIT

Qty.	Part Description	Part #
1	Hub for saw blade	89433
1	Bushing (includes hardware)	547251
1	Service Bulletin 207 document	SB207
1	Service Bulletin 202 document	SB202

Before beginning the procedure, gather these supplies:



- Torque wrench and socket head driver (Allen key)
- T30 Torx™ driver referred to in SB202 (also called star or hexalobular internal shaped driver).
- Large screwdriver or small pry bar
- 2 flat head Torx screws, 1/4"x28x5/8"
(These are the same as the screws used to hold the saw blade to the hub, but these must be discarded when procedure is complete as they may be damaged.)





Continue to use the existing snap ring. If a new snap ring is needed, order PN 379008.

If you have any questions, call MiTek Machinery Division Customer Service at 800-523-3380.

Procedure

Electrical Lockout/Tagout Procedures





	 WARNING
	<p>ELECTROCUTION HAZARD!</p> <p>Verify that all power to the machine has been turned off and follow approved lockout/tagout safety procedures before performing any maintenance.</p> <p>All electrical work must performed by a qualified electrician.</p> <p>If it is absolutely necessary to troubleshoot an energized machine, follow NFPA 70E for proper procedures and personal protective equipment.</p>

Before performing maintenance on any machine with electrical power, lockout/tagout the machine properly. When working on a machine outside of the machine’s main electrical enclosure, not including work on the electrical transmission line to the machine, follow your company’s approved lockout/tagout procedures which should include, but are not limited to the steps here.

Figure 1: Lockout/Tagout on the Main Electrical Enclosure







1. Engage an E-stop on the machine.
2. Turn the disconnect switch handle on the machine’s main electrical enclosure to the “off” position. See Figure .

	 WARNING
	<p>ELECTROCUTION HAZARD.</p> <p>When the disconnect switch is off, there is still live power within the disconnect switch’s enclosure. Always turn off power at the building’s power source to the equipment before opening this electrical enclosure!</p>

3. Attach a lock and tag that meets OSHA requirements for lockout/tagout.

Pneumatic System Lockout/Tagout Procedure

	 WARNING
	<p>MOVING PARTS CAN CRUSH AND CUT.</p> <p>Always verify that power to the machine has been turned off and follow approved lockout/tagout procedures.</p> <p>Turn off the air switch before performing any maintenance on the equipment.</p>

	 WARNING
	<p>HIGH PRESSURE HAZARD.</p> <p>Bleed pneumatic lines before performing any maintenance on the pneumatic system.</p>

In order to ensure a safe operating environment, MiTek recommends that you check the tightness of all taper-lock bushings on a monthly basis, and also, each time a saw blade is changed. Check all saw blades to ensure that the saw hub taper-lock bushing tightness is within the recommended range described in Table 1 and Figures 2 and 3.

Replacing the Hub and Bushing

The drive shaft on the saw blade motor holds a saw hub. They are attached to each other with a taper-lock bushing in the center of the saw hub which simultaneously clamps onto the shaft and expands to hold the hub. The saw blade is then attached to the saw hub face.

Removing the Hub and Bushing

1. Position the saw blade assembly to make it easier to reach:
 - a) Rotate the angle of the saw blade so it is in a horizontal position (flat surface on top).
 - b) Adjust the elevation and stroke to a comfortable position for removing the blade and hub.
2. Lockout/tagout.
3. Remove the saw blade according to the instructions in SB202. The screws require a T30 Torx driver.



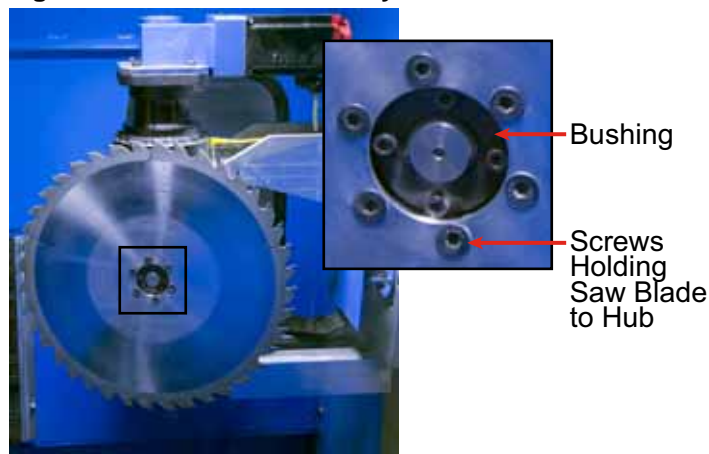

Figure 2: Motor-Hub Assembly



4. Remove the snap ring located on the end of the saw motor shaft (in the center of the bushing). Save for later use.
5. Remove the saw blade hub and bushing:
 - a) Using a socket head driver (Allen key), loosen the 4 screws shown in the black ring labeled *Bushing* in Figure 2. **DO NOT REMOVE THEM!**
 - b) Pull the hub and bushing away from the motor shaft and discard both.

Installing a New Hub and New Bushing

	 WARNING
	<p>Failure to keep the saw blade hub securely attached to the motor may allow the blade or other parts to come off during operation, causing severe personal injury or death.</p>

1. Clean all surfaces that will contact each other on the motor shaft, new bushing, and new hub.
2. Place the new bushing into the new hub.
3. Install the new hub and bushing:
 - a) Slide the new hub/bushing assembly onto the motor shaft and hand-tighten the 4 screws that came with the new bushing.

	NOTICE
	<p>Hub must bottom out on the motor shaft flange in order to set the blade center to the angle axis.</p>

- b) Hold the hub still as shown in Figure 3:
 - 1) To hold hub in position, fasten two screws to the saw hub. They should be the same size as the screws used for the saw blade.
 - 2) Position a large screwdriver or small pry bar between the two screws, as shown in Figure 3.
 - 3) Hold the hub in place with a screwdriver or small pry bar.

Figure 3: Holding the Hub Still
(Photo may differ from actual hub.)



- c) Set a torque wrench to the *Screws in bushing* setting as shown in Figure 4.

Figure 4: Torque Specs for Saw Blade and Hub
(View from side of saw, with blade at 90 degrees.)

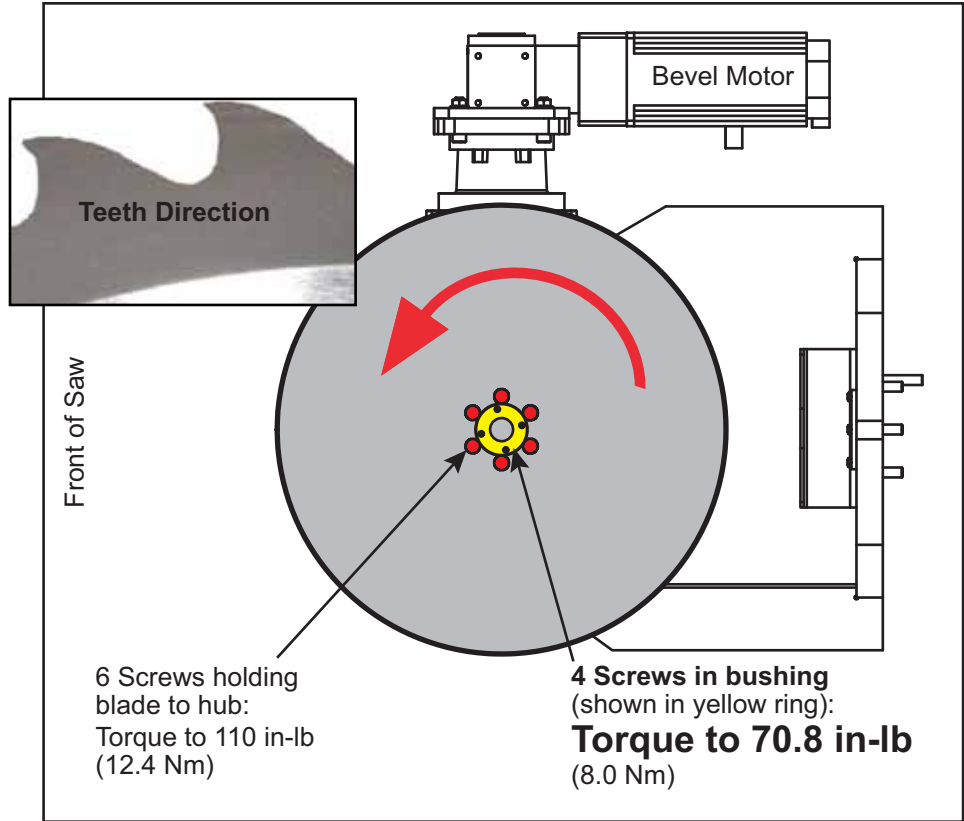

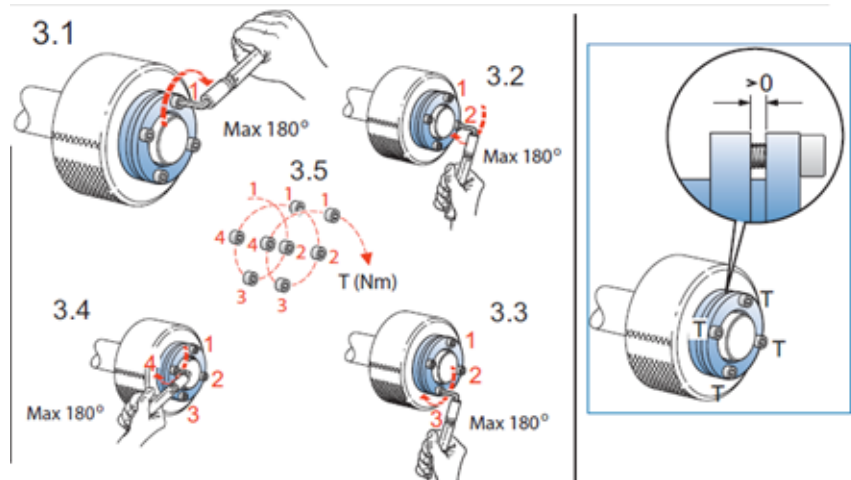

- d) Tighten the 4 bolts one half turn at a time, in the order shown in Figure 5 until it reaches the correct torque as shown in Figure 4.

Figure 5: Bolt Pattern for Tightening Saw Blade Hub to Shaft



4. Place the snap ring onto the blade motor shaft so the snap ring is seated in the groove on the end of the shaft.
5. Remove the 2 screws from the hub that were used in Figure 3, and discard.

	 WARNING
	<p>Do Not Re-use The Bolts Used in Figure 3!</p> <p>The bolts may sustain damage. Using damaged bolts to secure the saw blade may result in serious injury.</p>

6. Remove the lockout/tagout devices.
7. Test the stability of the hub by running the motor to ensure the hub does not wobble. It should run true and have no side-to-side motion.
8. Refer to *MiTek* Service Bulletin 202 to install the saw blade.
9. Refer to Service Bulletin 202 to test that the saw is ready for operation.

END OF SERVICE BULLETIN