

WSTS INSTALLATION GUIDE

The MiTek Pro Series WSTS Truss Screw installation is simplified with the use of an included hands free angle tool. This tool guides the installer to ensure proper installation angle.

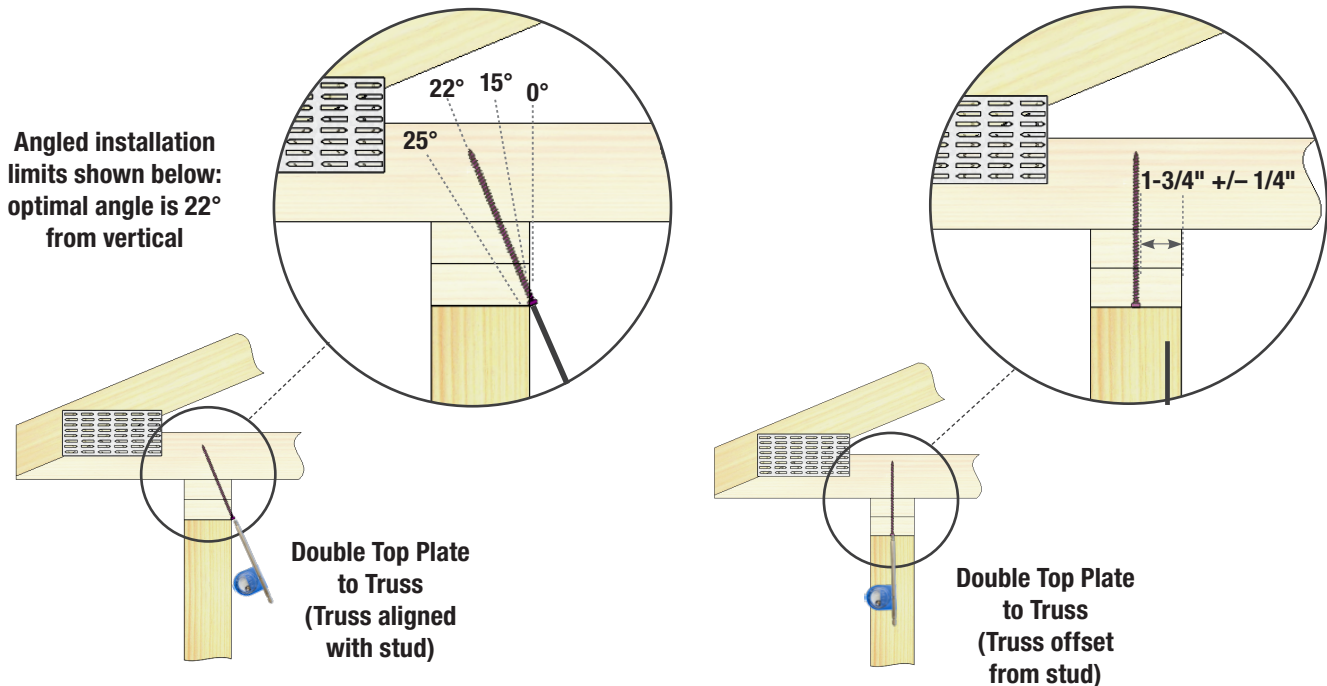
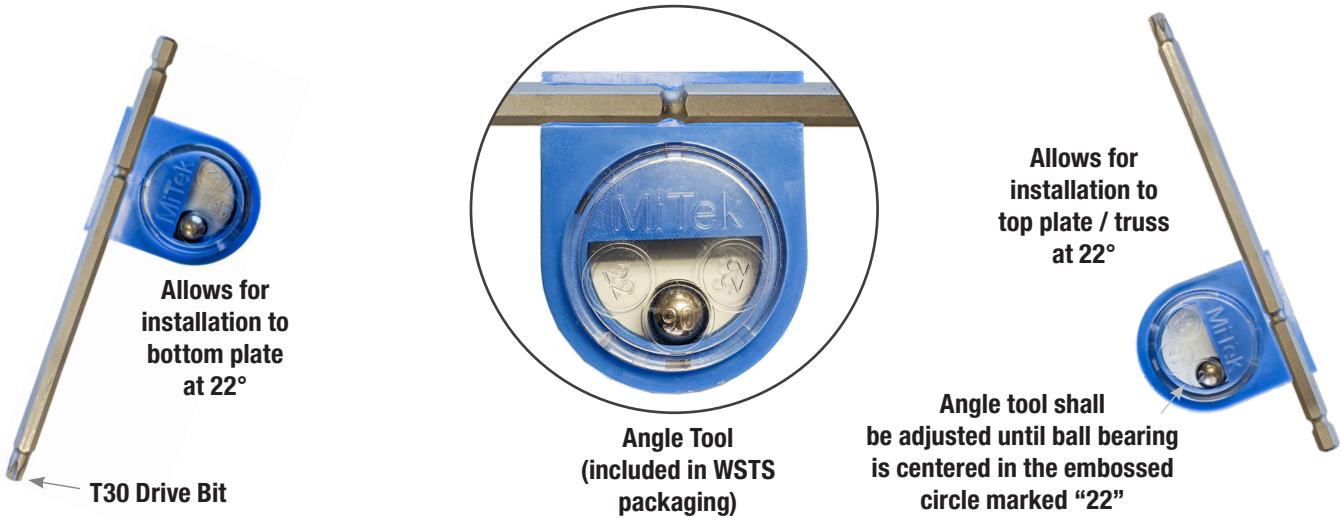

Customer Service & Technical Assistance

Phone: 1-800-328-5934 • Fax: 1-952-898-8605 • Email: USPcustomerservice@mii.com

WSTS INSTALLATION GUIDE

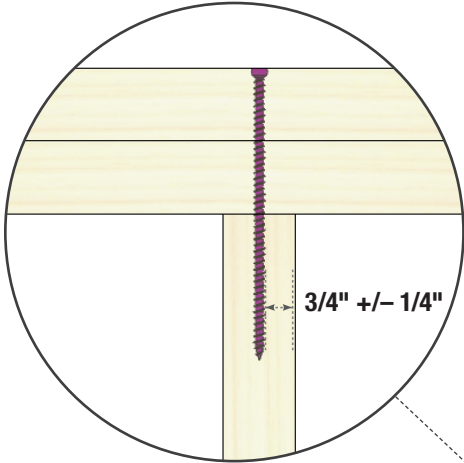

Double Top Plate to Stud

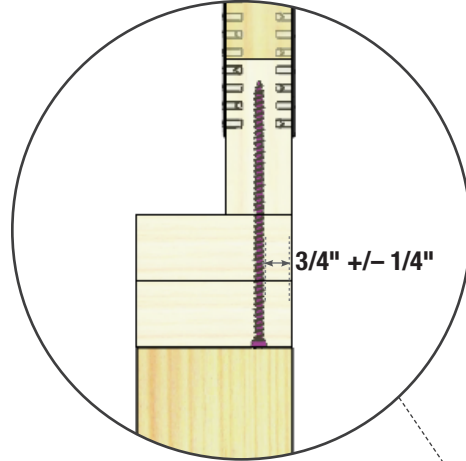
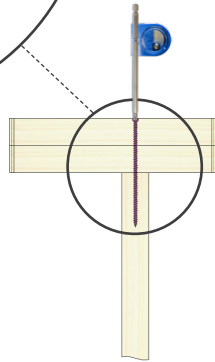

Double Top Plate to Truss (End Wall)

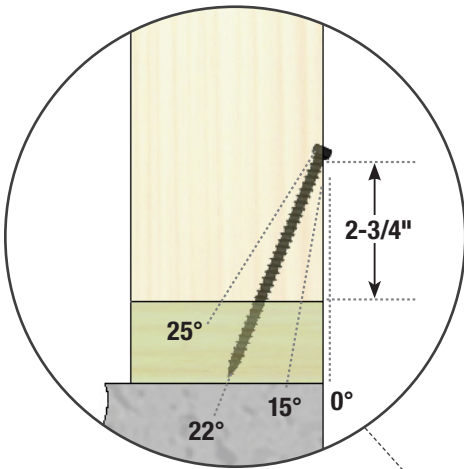
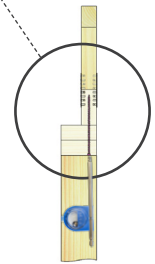

Stud to Single Bottom Plate Narrow Face (WSTS45)

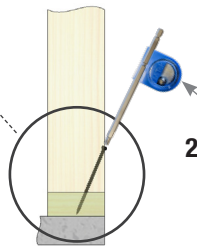

Angled installation limits shown below: optimal angle is 22° from vertical

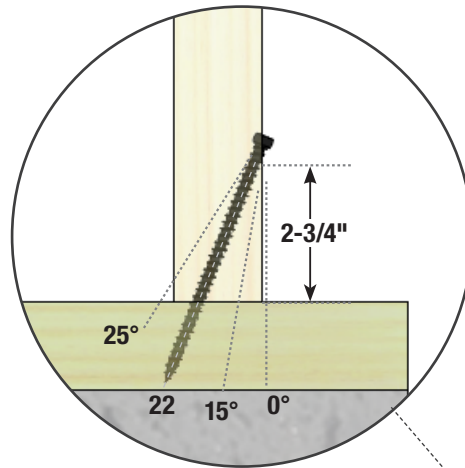

Stud to Single Bottom Plate Wide Face (WSTS45)

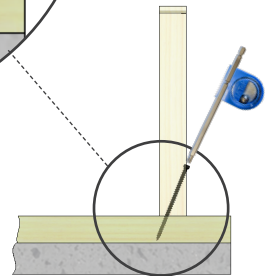

Tool indicates 22° from vertical

Customer Service & Technical Assistance

Phone: 1-800-328-5934 • Fax: 1-952-898-8605 • Email: USPcustomerservice@mii.com