



# Maintenance Manual



MatchPoint™

---

# BLADE™

Wood Processing System

Copyright © 2014, 2016 MiTek®. All rights reserved.  
Patented. See Legal Notice for list of patents.

Manual applies to U.S. equipment.

001080-MT

*If printing this manual from a file, it is highly recommended that it be printed in high resolution in color ink.  
Many of the graphics will be unclear and could create an unsafe condition if this recommendation is not followed.*

# Maintenance Manual

# *MatchPoint BLADE*<sup>TM</sup>

Wood Processing System



*U.S. and other patents pending.*

*Manual applies to North American  
and Australian equipment.*

**MiTek Machinery Division**  
**301 Fountain Lakes Industrial Drive**  
**St. Charles, MO 63301**  
**Phone: 800-523-3380**  
**Fax: 636-328-9218**  
**www.mii.com**

|                    |  |
|--------------------|--|
| Manual Set         | 001080   |
| This Manual        | 001080-MT rev. A   |
| Revision Date      | 9 December 2016  |
| Revised By         | R. Tucker  |
| Approved By        | M. Kanjee  |
| Print Date         | January 18, 2024   |
|                    |  |
| Orig Creation Date | 18 July 2014   |
| Created By         | R. Tucker  |
| Effectivity        | All  |
|                    |  |
| Applicability      | 89060 <i>BLADE</i> system,<br>89064-89069 Auto Deck<br>89535-89536 Skewed Conv |



# Legal Notice

## Patents

The *BLADE* wood processing system is made and sold under one or more of the following patents:

|               |                        |
|---------------|------------------------|
| US 6,539,830  | ZA 2008/00280          |
| US 6,702,096  | DE 1896228             |
| US 7870879    | FR 1896228             |
| AU 2006263691 | GB 1896228             |
| NZ 564779     | US 6702096 (Auto Deck) |

For use with US 6539830

For use with AU 783340

For use with CA 2398768

Other patents may apply

## Return Goods Policy

Return goods cannot be accepted without prior authorization and are subject to a restocking charge. The Seller certifies the articles specified herein were produced in compliance with all provisions of the Fair Labor Standards Act of 1938, as amended, including Section 12.—Rev. 6/98

## Reporting Errors and Recommending Improvements

To report errors or recommend improvements to this manual, please complete the Document Evaluation Form in the appendices. Mail or fax the form to:

MiTek Machinery Division  
301 Fountain Lakes Industrial Drive  
St. Charles, MO 63301  
Attn: Engineering Manager, Fax: 636-328-9218

# Notice of Change

Use this page to record Service Bulletins and Notices that you receive to keep your manual updated.

## **BLADE™**

### Wood Processing System

| Service Bulletin<br>or Notice # | Dated | Title |
|---------------------------------|-------|-------|
|                                 |       |       |
|                                 |       |       |
|                                 |       |       |
|                                 |       |       |
|                                 |       |       |
|                                 |       |       |
|                                 |       |       |
|                                 |       |       |
|                                 |       |       |
|                                 |       |       |
|                                 |       |       |
|                                 |       |       |
|                                 |       |       |
|                                 |       |       |
|                                 |       |       |
|                                 |       |       |
|                                 |       |       |
|                                 |       |       |
|                                 |       |       |
|                                 |       |       |
|                                 |       |       |

# Contents

## Preliminary Pages

|                               |            |
|-------------------------------|------------|
| <b>Legal Notice</b> .....     | <b>ii</b>  |
| <b>Notice of Change</b> ..... | <b>iii</b> |
| <b>Contents</b> .....         | <b>iv</b>  |

## Safety (English)

|  |           |
|--|-----------|
| <b>Safety Indicators: Signal Words</b> .....           | <b>1</b>  |
| <b>General Equipment Safety Rules</b> .....            | <b>2</b>  |
| Know Your Equipment .....                              | 2         |
| Personal Safety .....                                  | 2         |
| Installing the Equipment .....                         | 3         |
| Lockout/Tagout .....                                   | 3         |
| Keeping a Safe Environment .....                       | 3         |
| Operating and Maintaining the Equipment .....          | 4         |
| Electrical Safety .....                                | 4         |
| <b>Lockout/Tagout</b> .....                            | <b>5</b>  |
| Lockout/Tagout Guidelines .....                        | 5         |
| Electrical Lockout/Tagout Procedures .....             | 6         |
| Hydraulic System Lockout/Tagout Procedure .....        | 10        |
| Pneumatic System Lockout/Tagout Procedure .....        | 10        |
| <b>Troubleshooting With an Energized Machine</b> ..... | <b>10</b> |
| <b>Safety Tests</b> .....                              | <b>11</b> |
| Inspecting Indicators .....                            | 11        |
| Testing the E-stop Pushbuttons and Pull-Cords .....    | 12        |
| Testing Movement While E-stop is Active .....          | 13        |
| Testing E-Stops for Optional Equipment .....           | 14        |
| Testing Interlocked Doors .....                        | 15        |
| <b>Restricted Zone</b> .....                           | <b>17</b> |
| Know the Restricted Zone: Shown in Red .....           | 17        |
| Marking the Restricted Zone .....                      | 18        |
| <b>Safety Symbol Definitions</b> .....                 | <b>19</b> |
| <b>Declaration of Safety Conformity</b> .....          | <b>27</b> |
| <b>Treatment for Hazardous Substances</b> .....        | <b>28</b> |

## Seguridad (Español) Indicadores de seguridad: Palabras de aviso ... 30

|  |           |
|--|-----------|
| <b>Reglas de seguridad para el equipo de general</b> .....   | <b>31</b> |
| <b>Bloqueo/Etiquetado</b> .....  | <b>34</b> |
| Pautas de bloqueo/etiquetado .....   | 34        |
| Procedimientos de bloqueo/etiquetado eléctricos .....  | 35        |
| Procedimiento de bloqueo/etiquetado del sistema neumático .....  | 39        |
| <b>Solución de problemas con una máquina energizada</b> .....  | <b>39</b> |
| <b>Pruebas de seguridad</b> .....  | <b>40</b> |
| Indicadores de inspección .....  | 40        |
| Pruebas de los botones pulsadores del freno de<br>emergencia y las cuerdas de parada de emergencia ..... | 41        |
| Prueba de movimiento mientras el botón pulsador del freno<br>de emergencia está activo .....             | 43        |
| Prueba de los equipo opcional .....  | 44        |
| Prueba de las puertas interbloqueadas .....  | 45        |

# Contents

|  |                  |
|--|------------------|
| <b>Zona restringida</b> .....                              | <b>48</b>        |
| Conocer la zona restringida .....                          | 48               |
| Marcar la zona restringida .....                           | 49               |
| <b>Información adicional</b> .....                         | <b>49</b>        |
| <b>Introduction</b> .....                                  | <b>Chapter 1</b> |
| <b>Introduction to the Manual</b> .....                    | <b>50</b>        |
| Purpose and Scope of This Equipment Manual .....           | 50               |
| Understanding This Manual .....                            | 52               |
| Screen Shots .....   | 52               |
| Navigation .....   | 53               |
| Formatting Cues .....                                      | 53               |
| <b>Additional Resources</b> .....                          | <b>54</b>        |
| Supplemental Documentation .....                           | 54               |
| Board Stretcher Software Manual .....                      | 54               |
| Web Site .....   | 54               |
| <b>Contacting Us</b> .....                                 | <b>54</b>        |
| <b>Maintenance</b> .....                                   | <b>Chapter 2</b> |
| <b>Introduction to Maintaining Your Equipment</b> .....    | <b>55</b>        |
| <b>Performing Maintenance Safely</b> .....                 | <b>56</b>        |
| Before Operating This Equipment .....                      | 56               |
| Lockout/Tagout .....                                       | 57               |
| Important Safety Information .....                         | 58               |
| Making Adjustments and Replacing Parts .....               | 60               |
| Wearing Personal Protective Equipment .....                | 61               |
| Conducting Safety Tests .....                              | 61               |
| <b>Overview Graphics</b> .....                             | <b>62</b>        |
| <b>Calibration</b> .....                                   | <b>67</b>        |
| Homing the Gripper, LASM, and Stroke .....                 | 67               |
| Calibrating the Angle, Bevel, Elevation, and CLS .....     | 67               |
| <b>Cleaning and Inspecting</b> .....                       | <b>68</b>        |
| Cleaning Debris and Dust Off the Machine .....             | 68               |
| Wiping Off the Machine .....                               | 68               |
| Cleaning the Printer .....                                 | 69               |
| Cleaning Electrical Components .....                       | 70               |
| Periodic Inspection .....                                  | 71               |
| Lubricating .....  | 72               |
| Overview of Lubrication Points .....                       | 72               |
| <b>Motors and Gearboxes</b> .....                          | <b>73</b>        |
| Maintenance and Location of Motors/Gearboxes .....         | 73               |
| Filling and Replacing the Lubrication Level .....          | 75               |
| Nord Gearboxes Only .....                                  | 75               |
| Adding Lubrication to Nabtesco™ Gearbox (Bevel Axis) ..... | 76               |
| Slippage Errors and Tightening Motor Couplings .....       | 78               |
| Changing the Rotation of a Motor .....                     | 82               |
| <b>Timing Belts</b> .....                                  | <b>84</b>        |
| Gripper Belts .....  | 85               |

# Contents

|  |            |
|--|------------|
| LASM and Stroke Belts                                    | 88         |
| <b>Linear Guide Bearings</b>                             | <b>89</b>  |
| Lubricating the Linear Guide Bearings                    | 89         |
| Bearing Locations and Quantities                         | 91         |
| Replacing a Linear Guide Bearing Block                   | 93         |
| <b>Elevation Jack Screw</b>                              | <b>96</b>  |
| <b>Saw Blade Motor</b>                                   | <b>96</b>  |
| <b>Saw Blade</b>   | <b>97</b>  |
| Direction of Blade Teeth                                 | 97         |
| Specs for New or<br>Used Saw Blades                      | 97         |
| When to Replace the Saw Blade                            | 97         |
| How to Replace the Blade                                 | 98         |
| <b>Felt Strips</b>                                       | <b>100</b> |
| Trimming the Felt  | 100        |
| Replacing the Felt Strips                                | 100        |
| <b>Elevation Pins</b>                                    | <b>101</b> |
| <b>Bumpers</b>   | <b>101</b> |
| <b>Brushes</b>   | <b>102</b> |
| <b>Shock Absorbers</b>                                   | <b>103</b> |
| Replacing a Shock Absorber                               | 103        |
| Adjusting a Shock Absorber                               | 104        |
| <b>Auto Deck Staging Conveyor</b>                        | <b>105</b> |
| Auto Deck Sequence of Events                             | 105        |
| Understanding the Lumber Stops                           | 106        |
| Operating the Lumber Stop Cylinders                      | 106        |
| Lubricating the Auto Deck Shaft                          | 107        |
| Tensioning the Auto Deck Chain                           | 107        |
| <b>Infeed Rail &amp; Gripper</b>                         | <b>108</b> |
| Overview of Gripper                                      | 108        |
| Gripper Clamping Finger Maintenance                      | 109        |
| Adjusting the Gripper Belt                               | 109        |
| Adjusting the Load Arms                                  | 109        |
| <b>Infeed Top Clamp and Side Clamp</b>                   | <b>110</b> |
| Raising the Clamp & Printer Assembly                     | 110        |
| Lubricating the Linear Guide Bearings                    | 111        |
| Shock Absorbers  | 111        |
| Adjusting Clamp Speed                                    | 112        |
| <b>LASM</b>  | <b>113</b> |
| LASM Belt and Bearings                                   | 113        |
| Replacing the LASM Spikes                                | 113        |
| <b>Outfeed Assembly</b>                                  | <b>114</b> |
| Lubricating the Outfeed Clamp Camfollowers               | 115        |
| Replacing Outfeed Clamp Camfollowers                     | 115        |
| Lubricating the Lumber Exit Chain Drive Motor & Bearings | 116        |
| Maintaining the Lumber Exit Chain                        | 116        |
| Adjusting the Lumber Exit Chain Tension                  | 117        |
| Adjusting the Lumber Exit Chain Location                 | 117        |

# Contents

|   |            |
|---|------------|
| Adjusting the Chain Guide Bracket                     | 118        |
| Adjusting the Outfeed Clamp                           | 119        |
| Removing the Existing Outfeed Clamp Assembly          | 121        |
| Installing the Existing Outfeed Clamp Assembly (2016) | 122        |
| <b>Waste Conveyor</b>                                 | <b>124</b> |
| Lubricating the Drive Shaft                           | 124        |
| Adjusting the Belt Tension                            | 125        |
| Adjusting the Belt Tracking                           | 126        |
| Replacing a Waste Conveyor Belt                       | 128        |
| <b>Powered Skewed Conveyor (optional equipment)</b>   | <b>130</b> |
| Aligning/Adjusting the Powered Skewed Conveyor        | 130        |
| Lubricating the Powered Skewed Conveyor               | 130        |
| Adjusting Belt Tension on Powered Skewed Conveyor     | 131        |
| Adjusting Sheaves Supporting the Belt                 | 132        |
| <b>Pneumatic System</b>                               | <b>133</b> |
| Pneumatic Components and Settings                     | 133        |
| Replacing the Filter Element on the Main Regulator    | 135        |
| Replacing Filter Element for Touch Screen Cooler      | 136        |
| Adjusting the Overall System Pressure                 | 137        |
| Draining Condensation & Sludge                        | 138        |
| Temperature Setting                                   | 139        |
| Adjusting the Main Pressure Switch                    | 140        |
| Printer System Relief Valve                           | 141        |
| Air Knives  | 142        |
| Additional Pneumatic Maintenance                      | 142        |
| <b>Using the Pull-Cord</b>                            | <b>143</b> |
| Resetting the Pull-Cord Switch                        | 143        |
| Adjusting the Pull-Cord Tension                       | 143        |
| <b>Main Electrical Enclosure</b>                      | <b>144</b> |
| <b>Understanding the Safety Features/Circuits</b>     | <b>145</b> |
| Understanding the Safety Relay and E-Stop Circuit     | 145        |
| Feedback Circuit                                      | 148        |
| Understanding the Door Lock Safety Circuit            | 151        |
| <b>PLC (Programmable Logic Controller)</b>            | <b>155</b> |
| What the PLC Controls                                 | 155        |
| Operating and Maintaining the PLC                     | 155        |
| Troubleshooting Tips for the PLC                      | 156        |
| <b>Safety Motion Sensor</b>                           | <b>157</b> |
| Understanding the Safety Motion Sensor                | 157        |
| Replacing the Safety Motion Sensor                    | 158        |
| Troubleshooting Tips for Safety Motion Sensor         | 161        |
| <b>E-Stop Module</b>                                  | <b>162</b> |
| <b>VFD</b>  |            |
| <b>(Variable Frequency Drive)</b>                     | <b>163</b> |
| Understanding VFDs                                    | 163        |
| Setting VFD Parameters                                | 163        |
| Replacing a VFD (Variable Frequency Drive)            | 163        |
| <b>Overloads</b>                                      | <b>164</b> |

# Contents

|   |            |
|---|------------|
| Motor Starter Overloads                               | 164        |
| Braking Resistor Overload for Saw Blade               | 165        |
| <b>Securing the Profinet Module</b>                   | <b>166</b> |
| <b>Inputs</b>   | <b>166</b> |
| <b>Fuses</b>  | <b>167</b> |
| Main Disconnect Fuses (3-Phase Power)                 | 167        |
| Terminal Block Fuses                                  | 168        |
| Branch Circuit Protection for Servo Motors            | 168        |
| Class J Fuses   | 169        |
| Printer Fuse  | 169        |
| Amplifier Fuse  | 169        |
| <b>Replacing the Blade Motor Cable</b>                | <b>170</b> |
| <b>Saw Computer and Electrical System</b>             | <b>177</b> |
| Touch Screen Computer Warranty                        | 177        |
| Replacing a Hard Drive                                | 177        |
| Replacing the Computer                                | 178        |
| <b>Software</b>                                       | <b>179</b> |
| Software Summary                                      | 179        |
| BLADE Software License                                | 180        |
| PLC Software  | 180        |
| Kepware Software: Installing                          | 181        |
| Kepware Software: Licensing                           | 182        |
| KepServerEX5 Configuration                            | 184        |
| <b>Specific Profile Changes on the Saw PC</b>         | <b>185</b> |
| Removing the Property Requiring a Keyboard            | 185        |
| Removing the Property Requiring CTRL-ALT-DELETE       | 185        |
| <b>Networking eWON (Ethernet Switch)</b>              | <b>186</b> |
| Connecting the eWON                                   | 186        |
| Resetting the eWON                                    | 187        |
| <b>Sensors</b>  | <b>188</b> |
| Overview of Sensors                                   | 188        |
| Sensor Gaps for Prox Switches (Home Sensors)          | 190        |
| Troubleshooting Home Sensors                          | 190        |
| Does the Home Sensor Have Power and Functionality?    | 191        |
| Adjusting & Troubleshooting the Crooked Lumber Sensor | 192        |
| <b>Troubleshooting</b>                                |            |
| <b>Appendix A</b>                                     | <b>200</b> |
| <b>Navigating the Troubleshooting Appendix</b>        | <b>200</b> |
| <b>Safety Notes for Troubleshooting</b>               | <b>201</b> |
| General Troubleshooting Safety Tips                   | 201        |
| Electrical Troubleshooting Safety Tips                | 202        |
| <b>Getting Started With Troubleshooting</b>           | <b>203</b> |
| Tools Needed  | 203        |
| Phase 1 Troubleshooting Steps                         | 203        |
| <b>Symptoms and Solutions</b>                         | <b>205</b> |
| Saw, Printer, Infeed Rail                             | 205        |
| Material Handling                                     | 214        |

# Contents

|  |            |
|--|------------|
| Printer .....  | 215        |
| <b>Software Errors .....</b>                           | <b>216</b> |
| <b>Indicators on Specific Electronic Devices .....</b> | <b>225</b> |
| PLC CPU Indicators .....                               | 225        |
| Ethernet Indicators .....                              | 225        |
| Amplifier Indicators .....                             | 225        |
| E-Stop Module Indicators .....                         | 225        |
| Servo Motion Module Indicators .....                   | 226        |
| <b>Axis Identification .....</b>                       | <b>227</b> |
| <b>Parts List</b>                                      |            |
| <b>Appendix B .....</b>                                | <b>228</b> |
| <b>Navigating the Parts List Appendix .....</b>        | <b>228</b> |
| Finding the Part Number .....                          | 228        |
| Ordering the Parts With Your Part Number .....         | 228        |
| <b>Safety Notes for Replacing Parts .....</b>          | <b>229</b> |
| <b>Part Numbers .....</b>                              | <b>230</b> |
| Spare Parts Kit .....                                  | 230        |
| Mechanical Parts .....                                 | 230        |
| Electrical Parts .....                                 | 231        |
| Printer & Pneumatic Parts .....                        | 231        |
| Documentation Part Numbers .....                       | 231        |
| <b>Maintenance Checklists</b>                          |            |
| <b>Appendix C .....</b>                                | <b>232</b> |
| <b>Navigating the Maintenance Checklists .....</b>     | <b>232</b> |
| <b>Safety Notes For Maintenance Checklists .....</b>   | <b>233</b> |
| <b>Daily &amp; Weekly Checklist .....</b>              | <b>234</b> |
| <b>Monthly Checklist .....</b>                         | <b>235</b> |
| <b>Annual Checklist .....</b>                          | <b>236</b> |
| <b>Periodic Checklist .....</b>                        | <b>236</b> |
| <b>Drawing Set</b>                                     |            |
| <b>Appendix D .....</b>                                | <b>237</b> |
| <b>Glossary</b>  | <b>238</b> |
| <b>Index</b>   | <b>I</b>   |



# Safety (English)



Refiérase a la página OP-29 para español.

For safety information in Spanish, refer to OP-29.

## Safety Indicators: Signal Words

The following signal words and colors are used throughout this document to indicate safety hazards. Pay careful attention when you see them. The level of severity differs for each signal word and color.

Signal words are accompanied by graphics showing what personnel should or should not do. The graphics are called safety symbols and are defined on page 19, but more specific text is provided every time a graphic is used throughout the manual. Everyone near the machine must be trained on how to read these safety indicators.

Failure to comply with the instructions accompanying each signal word may result in property damage, personal injury, or even death. Personnel must follow all safety procedures and practices to ensure the safest possible operation of this equipment. However, at no time is this document a substitute for common sense. Personnel must ensure that the work environment is safe and free of distractions.

### DANGER

Indicates an imminently hazardous situation which, if not avoided, is likely to result in death or serious injury.

### WARNING

Indicates a potentially hazardous situation which, if not avoided, may result in death or serious injury.

### CAUTION

When CAUTION is used **with** the safety alert symbol (yellow triangle), it indicates a potentially hazardous situation which, if not avoided, may result in minor or moderate injury.

When CAUTION is used **without** the safety alert symbol, it indicates a potentially hazardous situation which may result in equipment damage.

### NOTICE

Calls attention to information that is significant to understanding the operation at hand.

### ENVIRONMENTAL

Applies to conditions that may affect the environment but do not have an immediate, direct effect on personnel or equipment.

## General Equipment Safety Rules



Because it is impossible to anticipate every circumstance that might involve a hazard, the safety information provided in this equipment manual and on the machine is not all-inclusive. If this machine is operated or serviced using a procedure not specifically recommended by the manufacturer, the procedure shall be approved by a professional engineer to ensure it will not render the equipment unsafe. Use extreme caution and common sense at all times!

### Know Your Equipment

- Read this manual completely before using or maintaining the equipment. Do not operate this machine unless you have a thorough knowledge of the controls, safety devices, emergency stops, and operating procedures outlined in this manual.
- Read and follow all safety notes. Failure to comply with these instructions may result in economic loss, property damage, and/or personal injury including death.
- Refer to the lockout/tagout guidelines on the following pages to safely perform maintenance and troubleshooting of this equipment.
- Observe and obey all safety labels. Replace worn labels immediately.
- Use this equipment solely for the purpose described in this manual.
- Only qualified personnel should attempt to operate or perform maintenance on this equipment. “Qualified personnel” is defined as:

*...a person or persons who, by possession of a recognized degree or certificate of professional training, or who, by extensive knowledge, training, or experience, has successfully demonstrated the ability to solve problems relating to the subject matter and work—ANSI B30.2-1983*

*...one who has skills and knowledge related to the construction and operation of the electrical equipment and installations and has received safety training on the hazards involved—NEC 2002 Handbook*

### Personal Safety

- Always wear safety glasses and hearing protection in an industrial environment.
- Utilize a filtering face piece (dust mask) when working near sawdust.
- Wear proper clothing and appropriate personal protective equipment (e.g. safety glasses and hearing protection.) Do not wear loose clothing or jewelry. Confine long hair by tying it back.
- Use caution when lifting heavy parts or material.

## Installing the Equipment

- Follow installation instructions completely.
- This equipment is not for use in a residential area.



## Lockout/Tagout

- Before performing maintenance on the pneumatic or hydraulic systems, bleed the lines to eliminate pressure.
- Lockout/tagout all energized systems before performing maintenance on them. Refer to the *Lockout/Tagout Guidelines* section on page 5.

## Keeping a Safe Environment

- Keep children away. All visitors should be kept a safe distance from the work area. Hazards may not be apparent to individuals unfamiliar with the machine.
- Keep work areas well lit.
- Keep the work area clean and free of any trip or slip hazards.
- Do not use the equipment in damp or wet locations, or expose it to rain or snow.
- Minimize dust clouds and protect your equipment by cleaning dust in this manner:
  - Vacuum dust prior to blowing with air
  - Shut down electrical power and sources of ignition
  - If using compressed air, it should be a low compression (no more than 15 psi)
  - Powered cleaning equipment such as vacuums must be consistent with local governmental codes for use in dusty conditions.

## Operating and Maintaining the Equipment

- Ensure that all people, tools, and foreign objects are clear of the restricted zones before operating this equipment. The restricted zones are shown on page 17.
- Perform safety tests to ensure all E-stops are working properly before operating the equipment at the initial startup, after performing any maintenance, and in accordance with the maintenance schedule.
- In case of machine malfunction, stop the machine immediately using an E-stop and report the malfunction to a supervisor.
- Never leave the machine running unattended. Turn the power off! Do not leave the machine until all parts have come to a complete stop and all electrical power has been shut off.
- Check for worn or damaged parts regularly. Repair or replace them immediately.
- Keep the hydraulic, pneumatic, and electrical systems in good working order at all times. Repair leaks and loose connections immediately. Never exceed the recommended pressure or electrical power.
- Check that all safety devices are in working order before each shift starts. All protective guards and safety devices must be in place before and during use of the machine. Never disconnect or bypass any safety device or electrical interlock.
- Only qualified maintenance personnel shall remove or install safety devices.
- Periodically inspect the quality of the finished product.

## Electrical Safety

- Do not use any liquids in the interior of electrical cabinets.
- When using solvents on and around the machine, remove power to the machine to eliminate the chance of sparking, resulting in explosion or fire. Wear a respirator approved for use with solvents. Wear protective clothing, gloves, and safety glasses.

## Lockout/Tagout

### Lockout/Tagout Guidelines

**All lockout/tagout guidelines must be met according to OSHA 29 CFR 1910.147.** A specific procedure should be included in your company's energy control program. This manual is not intended to replace your company's de-energizing or lockout/tagout procedure required by OSHA, but merely to provide general guidance.

The term “lockout,” as used in this manual, means placing a lockout device on any and all energy sources to ensure that the energy isolating device and the equipment being controlled cannot be re-energized or operated until the lockout device is removed. The photos on the next page show where the electrical disconnects are located for this machine.



- Energy sources include electrical, mechanical, hydraulic, pneumatic, chemical, thermal, or other energy.
- In the case of electrical energy sources, the main power and control power to the machinery must be turned off and physically locked in the “off” position.
- A lockout device is usually a keyed padlock.
- If more than one person is working in a restricted zone, use a group lockout device that will allow each person to use a lock that can be removed only by the person performing the maintenance.

“Tagout” means that a prominent warning is securely fastened to an energy-isolating device to indicate that the equipment shall not be operated.

Whenever you see this symbol, lockout/tagout!



## Electrical Lockout/Tagout Procedures





### When Working on a Machine Outside the Machine's Main Electrical Enclosure



If working on the electrical transmission line to the machine, follow the procedure on page 9.

Before performing maintenance on any machine with electrical power, lockout/tagout the machine properly. When working on a machine outside of the machine's main electrical enclosure, not including work on the electrical transmission line to the machine, follow your company's approved lockout/tagout procedures which should include, but are not limited to the steps here.

1. Engage an E-stop on the machine.
2. Turn the disconnect switch handle to the "off" position. See Figure OP-1.

|   |  |
|---|--|
|   |  <b>WARNING</b>   |
|  | <p><b>ELECTROCUTION HAZARD.</b></p> <p><b>When the disconnect switch is off, there is still live power within the disconnect switch's enclosure. Always turn off power at the building's power source to the equipment before opening this electrical enclosure!</b></p> |

3. Attach a lock and tag that meet OSHA requirements for lockout/tagout.
4. Restrain or de-energize all pneumatic components, hydraulic components, and other parts that could have live or stored power.

**Figure SAFETY-1: Sample of a Lockout/Tagout Mechanism on an Electrical Enclosure**

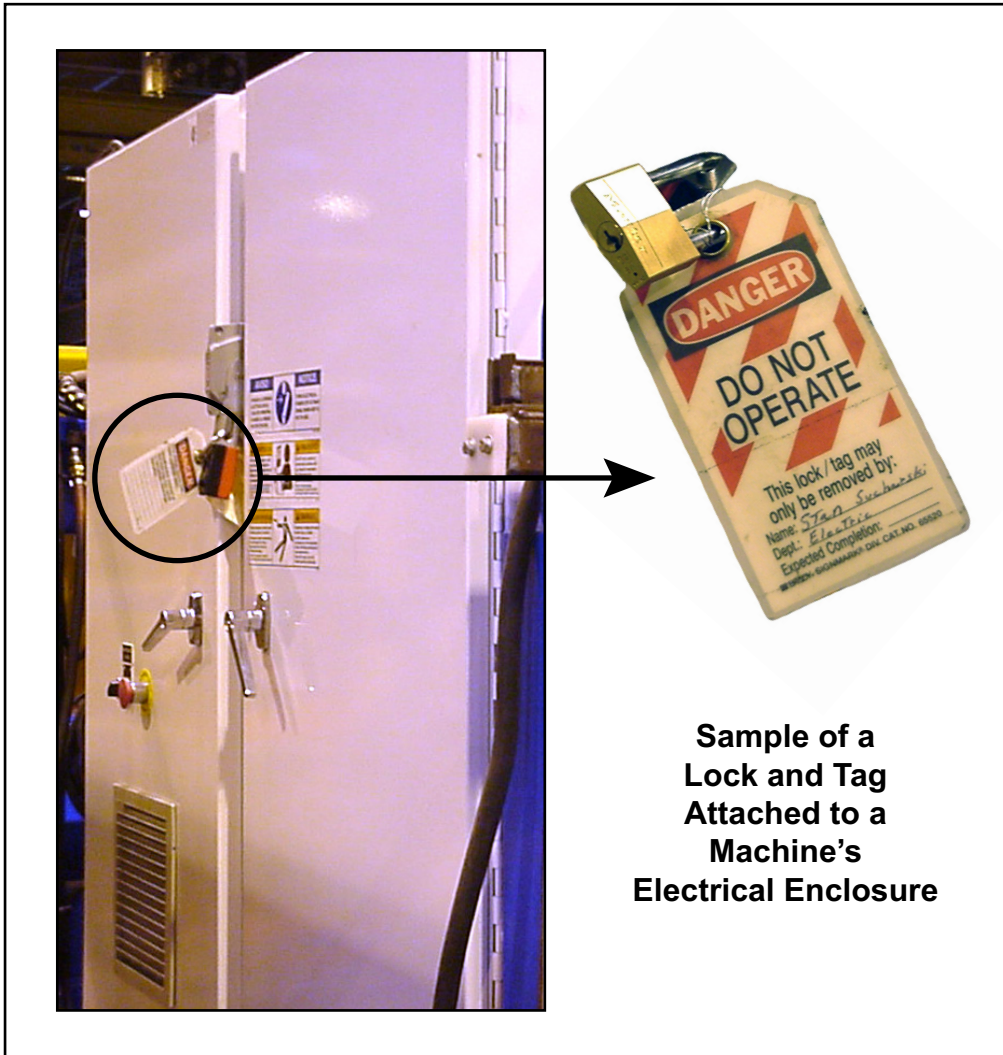

**Figure SAFETY-2: Lockout/Tagout on Additional Equipment in the System**



**Auto Deck Enclosure**

*May be replaced with optional infeed equipment.*

*Power can also be disconnected using saw's main disconnect switch.*



**Powered Skewed Conveyor Enclosure**

*(optional equipment)*

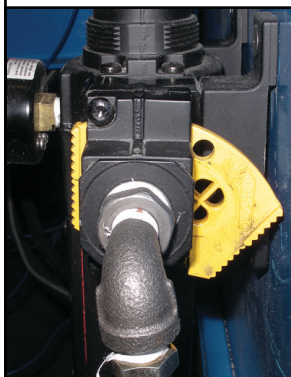

**Main Pneumatic Filter/Regulator**

- *Located on right side of saw.*
- *Yellow plate is shown in lockout position. Place lock and tag through holes in yellow plate.*
- *Pneumatic lines will bleed naturally when yellow plate is in lockout position.*
- *Ensure gauge reads 0 before performing replacing a supply bottle for the printer or performing any maintenance!*





### When Working on a Machine Inside the Machine's Main Electrical Enclosure or in the Electrical Transmission Line to the Machine

Before opening the main electrical enclosure, or attempting to repair or replace an electrical transmission line to the machine, lockout/tagout the machine properly. Follow your company's approved lockout/tagout procedures which should include, but are not limited to the steps here.

1. Engage an E-stop on the machine.
2. Shut the power to the machine off at the machine's power source which is usually an electrical service entry panel on the facility wall. One example of a locked-out power source panel is shown in Figure OP-3.
3. Attach a lock and tag that meets OSHA requirements for lockout/tagout.
4. Open the door to the enclosure in which you need access, and using a multimeter, verify that the power is off.

**Figure SAFETY-3: Sample of a Lockout/Tagout Mechanism on a Power Source Panel**



## Hydraulic System Lockout/Tagout Procedure

### When Lockout/Tagout is Not Required

If working on components other than the hydraulic system, but that requires you to be near the vicinity of movable hydraulic components, you must, at a minimum, physically restrain the hydraulic components from moving. If this is not possible, lockout/tagout the entire hydraulic system.



### When Lockout/Tagout is Required

Before attempting repair or performing maintenance on a hydraulic line or component, lockout/tagout the machine properly. Follow your company's approved lockout/tagout procedures.

## Pneumatic System Lockout/Tagout Procedure

### When Lockout/Tagout is Not Required

If working on components other than the pneumatic system, but that requires you to be near the vicinity of movable pneumatic components, you must, at a minimum, physically restrain the pneumatic components from moving. If this is not possible, lockout/tagout the entire pneumatic system.



### When Lockout/Tagout is Required

Before attempting repair or maintenance on a pneumatic line or component, lockout/tagout the machine properly. Follow your company's approved lockout/tagout procedures.

## Troubleshooting With an Energized Machine

Only a qualified electrician, using the personal protective equipment and following the procedures recommended in NFPA 70E should ever attempt service or repair of or near an energized area or component of the machine.

Whenever maintenance is performed while the equipment is electrically energized, there is a potential electric arc flash hazard. Refer to NFPA 70E for the personal protective equipment required when working with electrically energized components. Pneumatic and hydraulic components may move unexpectedly if not de-energized. Physically restrain any components capable of movement when working on or near those components.

## Safety Tests

This test procedure **MUST** be performed by qualified personnel at startup and after ANY maintenance, adjustment, or modification. Testing ensures that the safety system and machine control system work together to properly stop the machine.

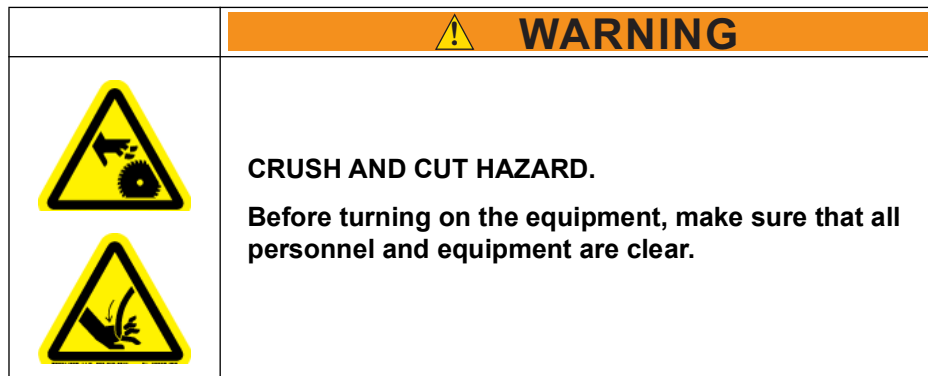

These test procedures **MUST** be performed by qualified personnel every day at startup and after ANY maintenance, adjustment, or modification. Testing ensures that the safety system and machine control system work together to properly stop the machine.



## Inspecting Indicators



1. While performing any of the following safety tests, check to ensure the *Blade In Motion* light located on the operator interface panel lights up when the blade is running.
2. While performing any of the following safety tests, check to ensure the beacon on top of the main electrical enclosure lights up when cutting is taking place.
3. Verify that all safety labels are present and legible.

## Testing the E-stop Pushbuttons and Pull-Cords

|  <b>WARNING</b>   |  |
|--|--|
| <br> | <p><b>CRUSH AND CUT HAZARD.</b></p> <p><b>Before turning on the equipment, make sure that all personnel and equipment are clear.</b></p> |

1. Start running the saw and all integrated components:
  - a) Power up the saw using the instructions on page OP-134.
  - b) Press the RESET button on the saw's operator interface panel.
  - c) Start any optional infeed and outfeed equipment. To start the Powered Skewed Conveyor, refer to page OP-158.
  - d) Press the Saw Motor START button on the saw's operator interface panel to start the motor.
  - e) Wait approximately 5 seconds, until the blade is up to full speed.
2. Prepare a stopwatch to time how long it takes for the saw blade to stop.
3. Activate any one of the E-stops listed here and measure the time between pressing the E-stop and when the blade comes to a complete stop.
  - Pushbutton on saw's operator interface panel
  - Pushbutton on main electrical enclosure
  - Pushbutton on Auto Deck operator interface
  - Pull-cord on Infeed Rail
4. Ensure that the blade and integrated components stop motion in a timely manner:
  - If the saw blade does not stop within 5-10 seconds, contact MiTek Machinery Division Customer Service immediately for resolution.
  - If all integrated components do not stop in a timely manner, lockout/tagout the entire wood processing system and arrange for a qualified service technician to troubleshoot and repair the equipment.
  - If the blade and integrated components stop as expected, repeat the procedure to test all E-stops listed in step 3.

## Testing Movement While E-stop is Active



|  <b>WARNING</b>   |  |
|--|--|
| <br> | <p><b>CRUSH AND CUT HAZARD.</b></p> <p><b>Before turning on the equipment, make sure that all personnel and equipment are clear.</b></p> |



An E-stop must be activated for this test to be useful.

1. Use the touch screen to manually move an axis.
2. Watch the axis that was chosen to see if it moves. Because an E-stop is activated, no movement should occur.
3. If movement does occur, Lockout/Tagout immediately and repair the problem.

## Testing E-Stops for Optional Equipment

|  <b>WARNING</b>   |  |
|--|--|
| <br> | <p><b>CRUSH AND CUT HAZARD.</b></p> <p><b>Before turning on the equipment, make sure that all personnel and equipment are clear.</b></p> |

Test E-stops for all optional equipment. The procedure below applies to the Powered Skewed Conveyor only.

1. Ensure that the Powered Skewed Conveyor's disconnect switch is in the ON position.
2. Ensure all system E-stops and safety devices are reset.
3. Turn the selector switch located on the Powered Skewed Conveyor to the START position and release the switch. The conveyor will begin movement.
4. Activate an E-stop on the Powered Skewed Conveyor.
5. Ensure that the Powered Skewed Conveyor, saw, and all peripheral equipment stop motion.
6. If any piece does not stop, lockout/tagout and arrange for a qualified service technician to repair the equipment.

## Testing Interlocked Doors



Certain doors are interlocked with the E-stop system and should not open when certain parts are in motion.



**SAW CHAMBER DOOR** should not open if the blade is moving.



**STROKE/ ELEVATION CHAMBER** door should not open if any axes are in motion.

1. Test that the **SAW CHAMBER DOOR** interlock is functioning by performing this procedure:

|  <b>WARNING</b>   |  |
|--|--|
| <br> | <p><b>CRUSH AND CUT HAZARD.</b></p> <p><b>Before turning on the equipment, make sure that all personnel and equipment are clear.</b></p> |

- a) Turn the saw blade on (see step 1 on page OP-12).
- b) Attempt to open the saw chamber door while pressing the *Request to Unlock* button (see page OP-112 and page OP-113).
  - The door should NOT open while the saw blade is running.
- c) Press the STOP button.
- d) Watch the lights on the operator interface panel.
  - A red *Blade In Motion* light should be illuminated when blade is moving.
  - A green *Blade Motion Stopped* light should illuminate when blade stops.
- e) Wait until the blade stops spinning, then attempt to open the saw chamber door again as described in step 1b).
  - The door should open now.
- f) With the door open, attempt to start the blade by pressing the green START button on the saw's operator interface panel.
  - The blade should NOT move.



- g) Resolve any inconsistencies:
- 1) If the door opens while the blade is still moving OR the blade spins with the door open, lockout/tagout the saw and arrange for a qualified service technician to repair the equipment.
  - 2) If the indicator lights are not behaving as expected, replace the bulb or repair the light.

|  |   |
|--|---|
|  <b>WARNING</b> |   |
|                 | <p><b>CUT AND CRUSH HAZARD.</b></p> <p><b>Never attempt to stop the saw blade with your hand or a hand-held object.</b></p> |



There may be instances when access is given to the saw chamber while the saw blade is coasting at a speed less than 5 RPM. This is normal and not a cause for alarm. Do not force the blade to stop.



2. Test that the **STROKE/ELEVATION CHAMBER DOOR** interlock is functioning by performing this procedure:

|  |  |
|--|--|
|  <b>WARNING</b>   |  |
| <br> | <p><b>CRUSH AND CUT HAZARD.</b></p> <p><b>Before turning on the equipment, make sure that all personnel and equipment are clear.</b></p> |

- a) Open the stroke/elevation chamber door (see page OP-112 and page OP-113).
- b) Ensure that the E-stop circuit is not engaged (no E-stops active).
- c) Attempt to manually move either the angle, elevation, or stroke axis (refer to instructions in step 1 on page OP-13).
  - The axis should NOT move while a door is open.
- d) If an axis moves while the door is open, lockout/tagout the saw and arrange for a qualified service technician to repair the equipment.



## Restricted Zone

|   |  |
|---|--|
|  |  <b>DANGER</b>  |
|   | <p>Stay out of the restricted zone when equipment is in use. Serious injury or death may result if personnel are in the restricted zone.</p> <p>Always look for personnel in the restricted zone before operating equipment.</p> |

### Know the Restricted Zone: Shown in Red

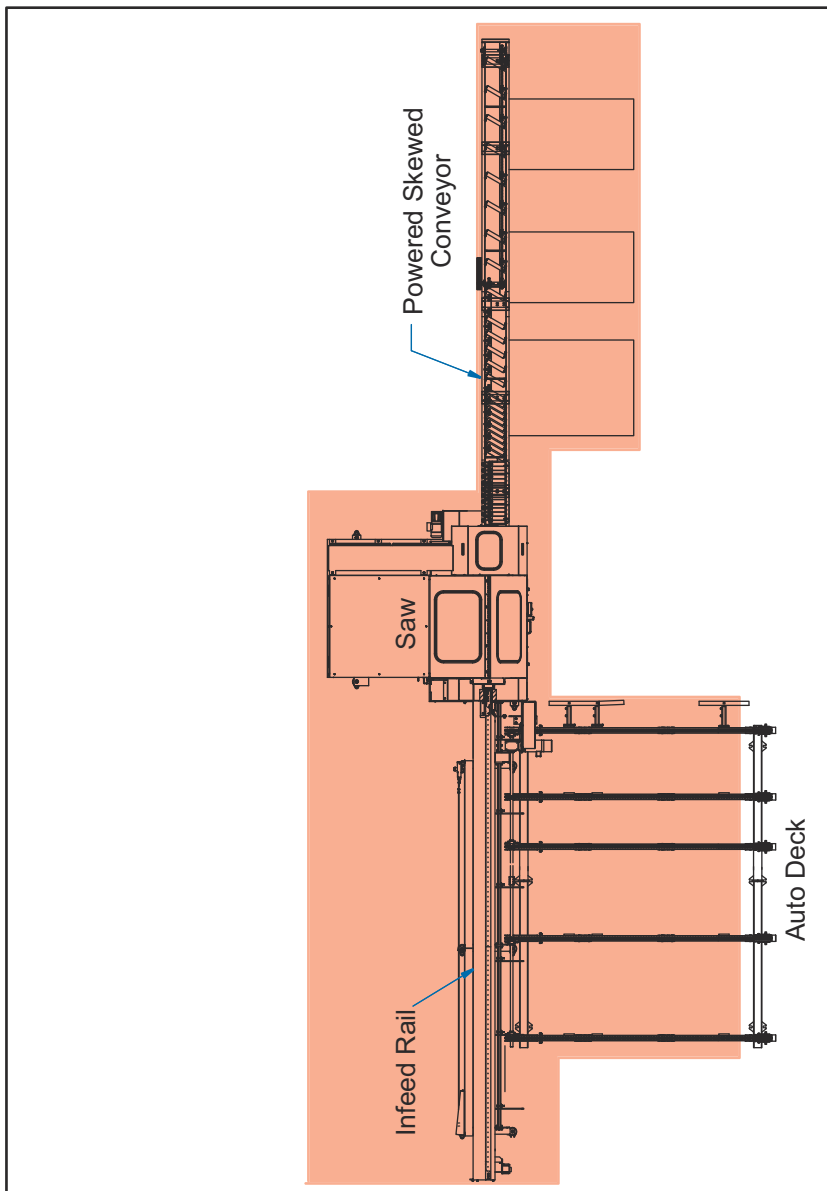



## **Marking the Restricted Zone**

The restricted zone must be marked so everyone near the equipment can clearly see the area where danger may exist.

MiTek offers Restricted Zone Tape that is easy to apply and has text in English and Spanish. Some equipment comes with restricted zone tape. If your machine did not come with restricted zone tape, you may order it from MiTek Machinery Division Customer Service.

Instructions for where and how to apply restricted zone tape can be found in the Installation Manual that came with your system or by obtaining Service Bulletin 181 from the MiTek Machinery Web site.

## Safety Symbol Definitions

The safety symbols shown in this section can be found throughout the manual to indicate hazards that are related to this equipment. All personnel expected to operate or maintain this equipment should become familiar with these safety symbols and what they mean.



This is the Electrical Hazard Symbol. It indicates that there are dangerous high voltages present inside the enclosure of this product and/or that a power source is present. To reduce the risk of fire or electric shock, do not attempt to open the enclosure or gain access to areas where you are not instructed to do so. Refer servicing to qualified service personnel only. This product should be operated only from the type of source indicated on the manufacturer's identification label. Installation should be in compliance with applicable sections of the national electric code. Consult your local building code before installing.



This is the user caution symbol. It indicates a condition where damage to the equipment resulting in injury to the operator could occur if operational procedures are not followed. To reduce the risk of damage or injury, refer to accompanying documents, follow all steps or procedures as instructed.



Hot surface! Surface temperature can exceed greater than 70°C during normal operation. Do not touch.



Ventilation - Slots and openings in the cabinet are provided for ventilation and to ensure reliable operation of the product. To protect the unit from overheating, those openings must not be blocked or covered. This product should not be placed in a built-in installation, such as a wall cutout, unless proper ventilation is provided. Hot temperatures will result.



Operation of this equipment may result in flying debris and excessive noise. To reduce the risk of injury, wear only approved PPE.



Crush hazard! Keep hands clear.



Keep hands away from moving parts.



High pressure hose. Use appropriate PPE when working on equipment. Maintain safe pressure levels at all times.



Hydraulic hose is under great pressure. Use safe operating procedures at all times.



Equipment produces loud noise in excess of 100 DBA during operation. Use appropriate hearing protection when in vicinity of this equipment.



Crush hazard from above



Caustic chemicals used in this area. Use appropriate PPE.



Slip hazard! Use of approved footwear is required.



Keep hands clear of cutting parts.





Keep hands and body clear.





The operation of this equipment requires the use of PPE.  
Do not operate without wearing required protective clothing.





Refer to manual - After installation, read the user's guide carefully before operating. Follow all operating and other instructions carefully.



Circuits are live - Lockout/tagout the upstream power source.



Lockout in a de-energized state



Lift Point - In order to reduce the likelihood of damage to the equipment, use only the lift points indicated in the manual.



Read all safety warnings and instructions before proceeding.





Two- or three-man lift required to safely move this equipment. Refer to installation manual.



Hazardous moving parts are located behind this access panel. Do not operate this equipment without all guards and covers in place.



Do not place containers with liquids such as coffee, water, sodas, etc. on this unit.

Do not operate this equipment in a wet environment.



Do not expose to water



No lift point. Do not lift this device with a hook/crane assembly. Damage to the equipment will be incurred. Refer to the installation instructions.



Do not use non-approved lubricants in this machine.



Unauthorized persons are not allowed beyond this point.



Do not operate without guards and covers in place



Do not discard into municipal waste stream



oil drop



## **Declaration of Safety Conformity**



Conforms Electrically to:

- NFPA 79
- NEC Electrical code
- Electrical enclosures carry UL508A and the CUL for Canada
- Safety circuit conforms to Category 4 redundant monitoring

Conforms Mechanically to:

- 10CFR 1910
- ANSI B11.19

## Treatment for Hazardous Substances

|  <b>WARNING</b>   |  |
|--|--|
| <br> | <p><b>PRINTER INK AND CLEANER IS HIGHLY FLAMMABLE!</b></p> <p><b>Keep away from extreme heat, sparks, or open flame.</b></p> <p><b>No smoking near these substances.</b></p> |

**Table 1: General Safety Data**

|                              | Printer Ink  | Printer Cleaner  | Most Hydraulic Fluid                             |
|------------------------------|--|--|--|
| Primary Hazards              | Flammable  | Flammable  | None   |
| Method of extinguishing fire | Alcohol-resistant foam, carbon dioxide, dry powder, water fog-<br>-NOT water | Alcohol-resistant foam, carbon dioxide, dry powder, water fog-<br>-NOT water | Water fog, foam, dry chemical, or carbon dioxide |
| Protective Equipment         | Gloves   | Gloves   | None   |
|                              | Goggles  | Goggles  |  |
|                              | Eyewash station  | Eyewash station  |  |

**Table 2: How to Treat Contact With a Hazardous Substance**

| If Substance Gets On... | Then Do This...                               |  |                                      |
|-------------------------|---|--|--------------------------------------|
|                         | Printer Ink                                   | Printer Cleaner  | Most Hydraulic Fluid                 |
| Skin/Clothing           | Rinse, remove clothing, then wash skin w/soap | Rinse, remove clothing, then wash skin w/soap                          | Low concern                          |
| Hair                    | Wash with soap and water                      | Wash with soap and water   | Low Concern                          |
| Eyes                    | Flush with water                              | Flush with water, remove contact lenses if possible, continue flushing | Flush with water (low concern)       |
| Ingested                | Do NOT induce vomiting                        | Do NOT induce vomiting   | Do NOT induce vomiting (low concern) |
| Inhalation              | Move to fresh air                             | Move to fresh air  | Low concern                          |

# Seguridad (Español)

**Sea cuidadoso.  
Protéjase.**



## Indicadores de seguridad: Palabras de aviso

Las siguientes palabras y colores de aviso se utilizan a lo largo de este documento para indicar riesgos de seguridad. Preste suma atención cuando los vea. El nivel de gravedad es diferente por cada palabra o color de aviso.

Las palabras de aviso van acompañadas por gráficos que muestran al personal lo que deben y no deben hacer. Los gráficos se llaman símbolos de seguridad y se definen en la página 56, pero se proporciona un texto más específico cada vez que se utiliza un gráfico por todo el manual. Todas las personas que estén cerca de una máquina tienen que ser capacitadas en cómo leer estos indicadores de seguridad.

No cumplir las instrucciones que acompañan cada palabra de aviso puede producir daños a la propiedad, lesiones personales e incluso la muerte. El personal debe seguir todos los procedimientos y prácticas de seguridad establecidos para asegurar el uso más seguro posible de este equipo. No obstante, en ningún caso este documento reemplaza el sentido común. El personal debe asegurarse de que el entorno de trabajo sea seguro y esté libre de distracciones.

### **PELIGRO**

Indica una situación potencialmente peligrosa que, si no se evita, podría producir la muerte o lesiones graves.

### **ADVERTENCIA**

Indica una situación potencialmente peligrosa que, si no se evita, podría producir la muerte o lesiones graves.

### **PRECAUCIÓN**

Indica una situación potencialmente peligrosa que, si no se evita, puede producir lesiones menores o moderadas.

### **AVISO**

Llama la atención a información importante para entender la operación que se desea realizar.

### **AMBIENTAL**

Se aplica a condiciones que pueden afectar el entorno pero que no tienen un efecto inmediato o directo sobre el personal o el equipo.

## Reglas de seguridad para el equipo de general



Debido a la imposibilidad de anticipar todas las circunstancias que podrían constituir un riesgo, la información de seguridad suministrada en este manual del equipo y sobre la máquina no es exhaustiva. Si se utiliza o realiza el mantenimiento de esta máquina utilizando un procedimiento no recomendado específicamente por el fabricante, el procedimiento deberá ser aprobado por un ingeniero profesional para asegurarse de que no afecte la seguridad del equipo. ¡Manéjese siempre con suma precaución y sentido común!

### Conozca su equipo

- Lea este manual en su totalidad antes de utilizar o mantener el equipo. No utilice esta máquina a menos que esté perfectamente familiarizado con los controles, los dispositivos de seguridad, los frenos de emergencia y los procedimientos operativos que se describen en este manual.
- Lea y siga todas las notas de seguridad. El no cumplimiento de estas instrucciones podría producir pérdidas económicas, daños a la propiedad y lesiones personales, incluida la muerte.
- Refiérase a las pautas de bloqueo/etiquetado proporcionadas en las siguientes páginas para realizar el mantenimiento y solucionar problemas de este equipo en forma segura.
- Observe y cumpla con todas las etiquetas de seguridad. Cambie las etiquetas gastadas inmediatamente.
- Utilice este equipo únicamente para el propósito que se describe en este manual.
- Sólo personal calificado debe intentar utilizar o realizar el mantenimiento de este equipo. Por "personal calificado" se entiende:

*...una persona o personas que, por el hecho de poseer un título o certificado de capacitación profesional reconocido o que, por sus amplios conocimientos o experiencia, han demostrado con éxito estar capacitados para resolver problemas relacionados con el tema y el trabajo en cuestión—ANSI B30.2-1983*

*...una persona que posee habilidades y conocimientos relacionados con la construcción y uso de equipos e instalaciones eléctricas y que ha recibido capacitación en seguridad sobre los riesgos posibles—NEC 2002 Handbook*

### Seguridad personal

- Use siempre lentes de seguridad y protección auditiva en un entorno industrial.
- Utilice una máscara protectora cuando trabaje cerca de aserrín.
- Utilice ropa adecuada y equipo de protección personal apropiado (por ejemplo, lentes de seguridad y protección auditiva.) No use ropa suelta ni joyas. Si tiene el cabello largo, áteselo para atrás.
- Proceda con precaución cuando levante piezas o materiales pesados.

## Instalación del equipo

- Siga las instrucciones de instalación al pie de la letra.
- No utilizar este equipo en zonas residenciales.



## Procedimientos de Bloqueo/Etiquetado

- Antes de realizar el mantenimiento de los sistemas neumáticos o hidráulicos, purgue las líneas para eliminar la presión.
- Bloquee y etiquete todos los sistemas energizados antes de realizar tareas de mantenimiento en ellos. Refiérase a la sección *Pautas de bloqueo/etiquetado* en la página 34.

## Cómo mantener un entorno seguro

- Mantenga alejados a los niños. Todos los visitantes deben mantenerse a una distancia segura del área de trabajo. Los riesgos pueden no ser evidentes a las personas no familiarizadas con la máquina.
- Mantenga las áreas de trabajo bien iluminadas.
- Mantenga el área de trabajo limpia y libre de cualquier riesgo de tropiezo o resbalamiento.
- No utilice el equipo en lugares húmedos o mojados y no lo exponga a la lluvia o a la nieve.
- Minimice las nubes de polvo y proteja su equipo quitando el polvo de la siguiente manera:
  - Aspire el polvo antes de soplarlo con aire
  - Apague la alimentación eléctrica y todas las fuentes de ignición
  - Si usa aire comprimido, debe ser a compresión baja (no más de 15 psi)
  - El equipo eléctrico de limpieza como las aspiradoras debe cumplir con los códigos del gobierno local para uso en condiciones polvorientas.

## Uso y mantenimiento del equipo

- Asegúrese de que no haya personas, herramientas y objetos extraños en las zonas restringidas antes de utilizar este equipo. Las zonas restringidas se indican en la página 48.
- Realice pruebas de seguridad para verificar que todos los frenos de emergencia funcionen adecuadamente antes de utilizar el equipo por primera vez, después de realizar cualquier tarea de mantenimiento y según la frecuencia de mantenimiento establecida.
- En caso de que la máquina no funcione correctamente, deténgala inmediatamente utilizando un freno de emergencia e informe el problema a un supervisor.



- No deje nunca la máquina encendida si no está junto a ella. ¡Apáguela! No la abandone hasta que todas las piezas se detengan completamente y hasta que se haya apagado la alimentación eléctrica.
- Verifique periódicamente que no haya piezas gastadas o dañadas. Repárelas o cámbielas inmediatamente.
- Mantenga los sistemas hidráulicos, neumáticos y eléctricos en buen funcionamiento en todo momento. Repare las fugas y las conexiones sueltas inmediatamente. No exceda nunca la presión ni potencia eléctrica recomendadas.
- Verifique que todos los dispositivos de seguridad estén en buen funcionamiento antes de comenzar de cada turno. Todos los dispositivos protectores y de seguridad deben estar en su lugar antes y durante el uso de la máquina. No desconecte ni evite nunca ningún dispositivo de seguridad ni interbloqueo eléctrico.
- Solo el personal de mantenimiento calificado puede quitar o instalar los dispositivos de seguridad.
- Inspeccione periódicamente la calidad del producto terminado.

### **Seguridad eléctrica**

- No utilice líquidos en el interior de los gabinetes eléctricos.
- Cuando utilice disolventes sobre o alrededor de la máquina, desconecte la alimentación para eliminar las probabilidades de chispas, que pueden producir una explosión o incendio. Use un respirador aprobado para el uso con disolventes. Use ropa protectora, guantes y lentes de seguridad.

## Bloqueo/Etiquetado

### Pautas de bloqueo/etiquetado

**Deben cumplir con todas las pautas de bloqueo/etiquetado conforme a la norma OSHA 29 CFR 1910.147.** El programa de control de energía de la compañía debe incluir un procedimiento específico. El objetivo de este manual no es reemplazar el procedimiento de desenergización o bloqueo/etiquetado requerido por la OSHA, sino proporcionar pautas orientativas generales.

El término "bloqueo", según se utiliza en este manual, se refiere a la colocación de un dispositivo de bloqueo en las fuentes de energía para asegurar que el dispositivo aislador de energía y el equipo controlado por éste no puedan reenergizarse o utilizarse hasta que se retire dicho dispositivo.

Las fotos de la página siguiente muestran los lugares en los que se encuentran los interruptores de desconexión eléctrica de esta máquina.



- Las fuentes de energía incluyen energía eléctrica, mecánica, hidráulica, neumática, química, térmica y otras.
- En el caso de fuentes de energía eléctrica, la alimentación principal y la alimentación de control a la maquinaria deben apagarse y bloquearse físicamente en la posición "off" (apagado).
- Por lo general, como dispositivo de bloqueo se utiliza un candado con llave.
- Si hay más de una persona trabajando en una zona restringida, utilice un dispositivo de bloqueo grupal que permita a cada persona utilizar un candado que sólo pueda ser retirado por la persona que realiza el mantenimiento.

"Etiquetado" significa que debe colocarse una advertencia fácil de ver en un dispositivo aislador de energía que indique que el equipo no debe utilizarse.

Siempre que vea este símbolo, ¡Bloquee/Etiqueta!



## Procedimientos de bloqueo/etiquetado eléctricos



### Cuando trabaja en una máquina fuera del gabinete eléctrico principal de la máquina



Si trabaja en la línea de transmisión eléctrica a la máquina, siga el procedimiento de la página 38.

Antes de realizar el mantenimiento de cualquier máquina con alimentación eléctrica, bloquee y etiquete la máquina de forma adecuada. Cuando trabaje en una máquina fuera del gabinete eléctrico principal de la máquina, salvo en el caso de trabajos en la línea de transmisión eléctrica a la máquina, siga los procedimientos de bloqueo/etiquetado aprobados por la compañía, los cuales deberían incluir, entre otros, los pasos aquí indicados.

1. Coloque un freno de emergencia sobre la máquina.
2. Coloque el mango del interruptor con fusibles en la posición "apagado/apagada".  
Vea la page OP-36.

|   |   |
|---|---|
|   |  <b>WARNING</b>  |
|  | <p><b>RIESGO DE ELECTROCUCIÓN.</b></p> <p><b>Cuando el interruptor con fusibles está apagado, sigue habiendo energía dentro del gabinete del interruptor. ¡Apague siempre la alimentación en la fuente de alimentación del edificio antes de abrir este gabinete eléctrico!</b></p> |

3. Coloque un candado y una etiqueta que cumplan con los requisitos de bloqueo/etiquetado de la OSHA.
4. Trabe o desenergice todos los componente neumáticos, componentes hidráulicos y otras piezas que tengan alimentación directa o almacenada.

Figure SEGURIDAD-1: Un mecanismo de Bloqueo/Etiquetado en el gabinete eléctrico

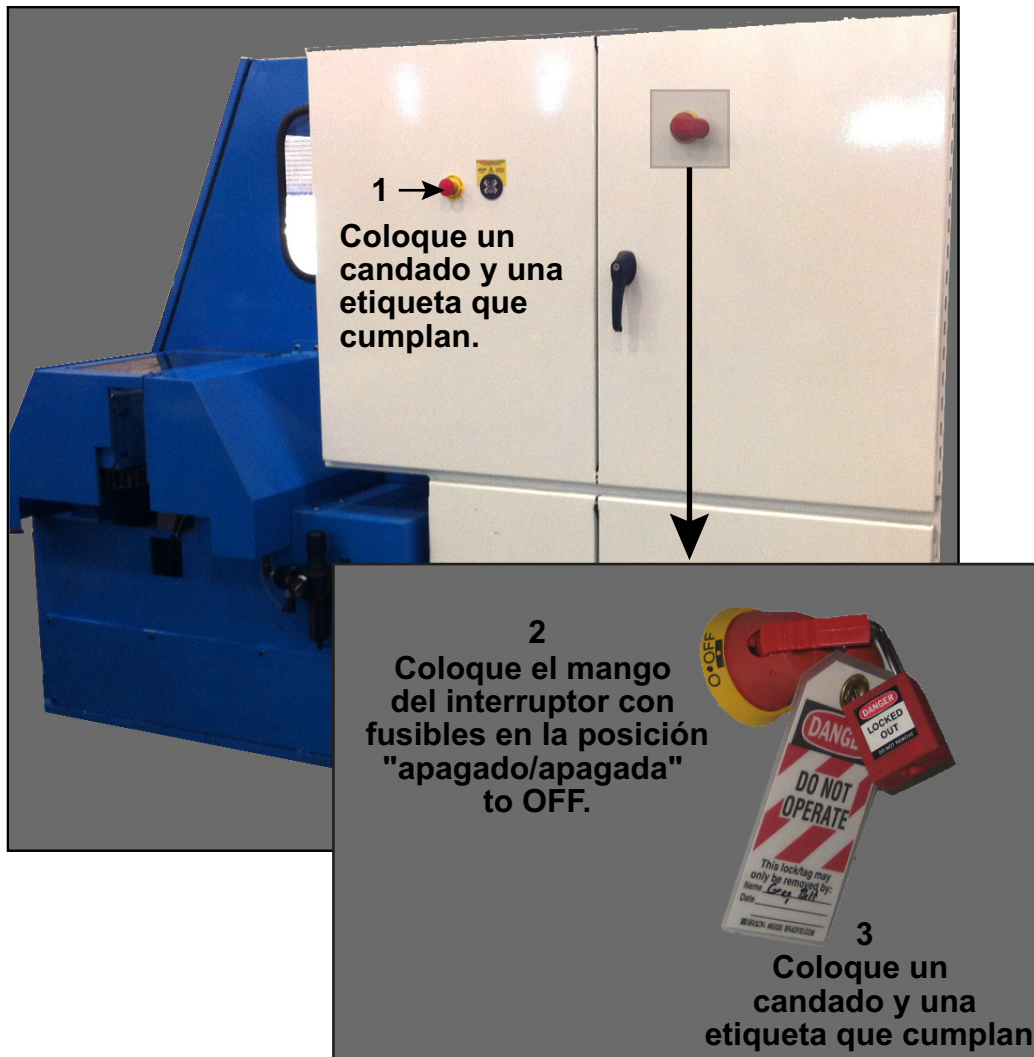

En la plataforma automática Auto Deck se corta la corriente cuando se apaga el interruptor de desconexión principal de la sierra en Figura SEGURIDAD SEGURIDAD-1.

La opción de la banda transportadora eléctrica con rodillos sesgados cuenta con un control de apagado eléctrico con el interruptor de desconexión principal de la sierra, pero aún existe la conexión trifásica.

El interruptor de desconexión principal de la sierra no afecta al sistema de recuperación de madera.

Figure SEGURIDAD-2: Bloqueo/etiquetado en equipo otras en el sistema



### Caja de la plataforma automática Auto Deck

*Se puede reemplazar con equipo opcional (guía de alimentación).*

*También es posible desconectar la electricidad usando el interruptor de desconexión principal de la sierra.*



### Caja de la banda transportadora eléctrica con rodillos sesgados (equipo opcional)

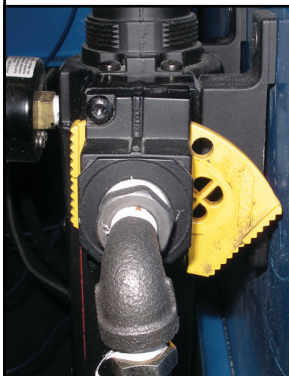

### Filtro/regulador neumático principal (ubicado del lado derecho de la sierra)

- Se encuentra del lado derecho de la sierra.
- La placa amarilla se muestra en posición bloqueada. Coloque el bloqueo y la etiqueta a través de los orificios en la placa amarilla.
- Las mangueras neumáticas sangrarán de manera natural cuando la placa amarilla se encuentre en posición de bloqueo.
- Verifique que la lectura del indicador sea 0 antes de reemplazar un frasco de suministro para la impresora o de realizar cualquier tipo de mantenimiento.



### **Cuando trabaje en una máquina dentro del gabinete eléctrico principal de la máquina o en la línea de transmisión eléctrica a la máquina**

Antes de abrir el gabinete eléctrico principal o intentar reparar o reemplazar una línea de transmisión eléctrica a la máquina, bloquee y etiquete la máquina en forma adecuada. Siga los procedimientos de bloqueo/etiquetado aprobados por la compañía, los cuales deberían incluir, entre otros, los pasos aquí indicados.

1. Coloque un freno de emergencia sobre la máquina.
2. Apague la alimentación a la máquina en la fuente de alimentación, que, por lo general, es un panel de entrada de suministro eléctrico que se encuentra en una pared de las instalaciones. En la Figura SEGURIDAD 1 se muestra un ejemplo de panel de fuente de alimentación bloqueado.
3. Coloque un candado y una etiqueta que cumplan con los requisitos de bloqueo/etiquetado de la OSHA.
4. Abra la puerta del gabinete al que necesita acceder y usando un multímetro verifique que la alimentación esté apagada.

**Figura SEGURIDAD-1: Ejemplo de un mecanismo de Bloqueo/Etiquetado en un panel de fuente de alimentación**



## **Procedimiento de bloqueo/etiquetado del sistema neumático**

### **Cuando no se requiere bloqueo/etiquetado**

Si trabaja con componentes que no son del sistema neumático pero que requieren su presencia en la proximidad de componentes neumáticos móviles, debe, como mínimo, trabar físicamente estos componentes para que no se muevan. Si no es posible, bloquee/etiquete todo el sistema neumático.



### **Cuando se requiere bloqueo/etiquetado**

Antes de intentar reparar o realizar el mantenimiento de una línea o componente neumático, bloquee/etiquete la máquina en forma apropiada. Siga los procedimientos de bloqueo/etiquetado aprobados por la compañía.



## **Solución de problemas con una máquina energizada**

Sólo un electricista calificado que utilice el equipo de protección personal y siga los procedimientos recomendados en la norma NFPA 70E debe intentar realizar tareas de reparación o mantenimiento en un área o componente energizados de la máquina o en su proximidad.

Cada vez que se realizan tareas de mantenimiento mientras el equipo está eléctricamente energizado, existe un riesgo potencial de formación de un arco eléctrico. Consulte en la norma NFPA 70E el equipo de protección personal requerido para trabajar con componentes eléctricamente energizados. Los componentes neumáticos e hidráulicos pueden moverse de manera imprevista si no se desenergizan. Trabe físicamente cualquier componente que pueda moverse cuando deba trabajar en ellos o en su proximidad.

## Pruebas de seguridad

Estos procedimientos de prueba DEBEN ser realizados por personal calificado durante la puesta en marcha todos los días y después de CUALQUIER tarea de mantenimiento, ajuste o modificación. Las pruebas permiten verificar si el sistema de seguridad y el sistema de control funcionan juntos y detienen la máquina de manera adecuada.



|  <b>CAUTION</b>   |  |
|--|--|
| <br> | <p><b>RIESGO DE APLASTAMIENTO Y CORTE.</b></p> <p>Antes de encender el equipo, asegúrese de que todo el personal y el equipo estén alejados.</p> |

## Indicadores de inspección

1. Mientras realiza cualquiera de las siguientes pruebas de seguridad, inspeccione que la luz de cuchilla en movimiento situada por una interfaz del operador se encienda cuando la cuchilla esté funcionando.
2. Mientras realiza cualquiera de las siguientes pruebas de seguridad, inspeccione para asegurarse de que la luz en la parte superior de la caja eléctrica principal se encienda cuando se realizan los cortes.
3. Verifique que todas las etiquetas de seguridad estén presentes y sean legibles.



## Pruebas de los botones pulsadores del freno de emergencia y las cuerdas de parada de emergencia

|  |  |
|--|--|
|  <b>CAUTION</b>   |  |
| <br> | <p><b>RIESGO DE APLASTAMIENTO Y CORTE.</b></p> <p>Antes de encender el equipo, asegúrese de que todo el personal y el equipo estén alejados.</p> |



1. Comience haciendo funcionar la sierra y todos los componentes integrados:
  - a) Encienda la sierra según las instrucciones de la página OP-134.
  - b) Presione el botón RESET (restablecer) en la interfaz del operador de la sierra.
  - c) Arranque cualquier equipo opcional de alimentación y de salida. Para arrancar la banda transportadora eléctrica con rodillos sesgados consulte la página OP-158.
  - d) Presione el botón START (Inicio) del motor de la sierra en la interfaz del operador de la sierra para que arranque el motor.
  - e) Espere aproximadamente 5 segundos, hasta que la cuchilla avance a toda velocidad.
2. Prepare un cronómetro para medir el tiempo que tarda en detenerse la cuchilla de la sierra.
3. Active cualquiera de los botones pulsadores del freno de emergencia señalados aquí y mida el tiempo entre cuando presiona el botón y cuando la cuchilla se detiene completamente.
  - Botón en la interfaz del operador de la sierra
  - Botón por la caja eléctrica principal
  - Botón en la interfaz del operador de la plataforma automática (Auto Deck)
  - Cuerda de parada de emergencia en el riel en la guía de alimentación





4. Asegúrese de que la cuchilla y los componentes integrados detengan el movimiento de una manera oportuna:
  - Si la cuchilla de la sierra no se detiene en un intervalo de 5 a 10 segundos, comuníquese de inmediato con Servicio al Cliente de la División de maquinaria de MiTek para que lo solucionen.
  - Si todos los componentes integrados no se detienen oportunamente, realice procedimientos de bloqueo/etiquetado en todo el sistema de procesamiento de madera y pida a un técnico de servicio calificado que diagnostique y repare el equipo.
  - Si la cuchilla y los componentes integrados se detienen como es de esperar, repita el procedimiento para probar todos los botones pulsadores del freno de emergencia señalados en el paso 3.

**Prueba de movimiento mientras el botón pulsador del freno de emergencia está activo**

|  <b>CAUTION</b>   |  |
|--|--|
| <br> | <p><b>RIESGO DE APLASTAMIENTO Y CORTE.</b></p> <p>Antes de encender el equipo, asegúrese de que todo el personal y el equipo estén alejados.</p> |





An E-stop must be activated for this test to be useful.



1. Use la pantalla táctil para mover un eje manualmente
2. Observe el eje que eligió para ver si se mueve. Como está activado un botón pulsador del freno de emergencia, no debe haber movimiento.
3. Si hay movimiento, realice de inmediato los procedimientos de bloqueo/ etiquetado y repare el problema.

## Prueba de los equipo opcional

|  <b>CAUTION</b>   |   |
|--|---|
| <br> | <p><b>RIESGO DE APLASTAMIENTO Y CORTE.</b></p> <p><b>Antes de encender el equipo, asegúrese de que todo el personal y el equipo estén alejados.</b></p> |

Pruebe los botones pulsadores de paro de emergencia para todo el equipo opcional. El siguiente procedimiento se aplica solamente a la banda transportadora eléctrica con rodillos sesgados.

1. Asegúrese de que el interruptor de desconexión de la banda transportadora eléctrica con rodillos sesgados esté en la posición ON (encendido).
2. Asegúrese de que todos los botones pulsadores del freno de emergencia y los dispositivos de seguridad del sistema estén restablecidos.
3. Mueva el interruptor selector situado en la banda transportadora eléctrica con rodillos sesgados a la posición START (Iniciar) y suelte el interruptor. La banda transportadora comenzará a moverse.
4. Active un botón pulsador de freno de emergencia en la banda transportadora eléctrica con rodillos sesgados.
5. Asegúrese de que la banda transportadora eléctrica con rodillos sesgados, la sierra y todo el equipo periférico dejen de moverse.
6. Si alguna pieza no se detiene, realice los procedimientos de bloqueo/etiquetado y pida a un técnico de servicio calificado que repare el equipo.

## Prueba de las puertas interbloqueadas



Ciertas puertas están interbloqueadas con el sistema de botón pulsador de freno de emergencia y no deben abrirse cuando ciertas piezas se estén moviendo.



La **PUERTA DE LA CÁMARA DE LA SIERRA** no debe abrirse si la cuchilla está en movimiento.

La puerta de la **CÁMARA DE LA CARRERA/ ELEVACIÓN** no debe abrirse si algún eje está en movimiento.



1. Pruebe que el interbloqueo de la **PUERTA DE LA CÁMARA DE LA SIERRA** funcione realizando este procedimiento:

|  <b>CAUTION</b>   |   |
|--|---|
| <br> | <p><b>RIESGO DE APLASTAMIENTO Y CORTE.</b></p> <p><b>Antes de encender el equipo, asegúrese de que todo el personal y el equipo estén alejados.</b></p> |

- a) Encienda la cuchilla de la sierra (vea el paso 1 en la página OP-41).
- b) Trate de abrir la puerta de la cámara de la sierra mientras presiona el botón *Request to Unlock*.
  - La puerta **NO** debe abrirse mientras esté funcionando la cuchilla de la sierra.
- c) Presione el botón STOP (alto).
- d) Observe las luces por la interfaz del operador.
  - Una luz roja debe estar encendida cuando la cuchilla se esté moviendo.
  - Una luz verde (*Blade Motion Stopped*) debe encenderse cuando se detenga la cuchilla.
- e) Espere hasta que la cuchilla deje de dar vueltas y luego trate de nuevo de abrir la puerta de la cámara de la cuchilla, como se describió en el paso 1b.
  - La puerta debe abrirse ahora.
- f) Con la puerta abierta, trate de arrancar la cuchilla presionando el botón START (Iniciar) verde en la interfaz del operador de la sierra.
  - La cuchilla **NO** debe moverse.

g) Resuelva cualquier incongruencia:



- 1) Si se abre la puerta mientras la cuchilla todavía está en movimiento O la cuchilla gira con la puerta abierta, realice los procedimientos de bloqueo/etiquetado en la sierra y pida a un técnico de servicio calificado que repare el equipo.
- 2) Si las luces indicadoras no se comportan como se esperaba, reemplace la bombilla o repare la luz.

|  <b>CAUTION</b>   |  |
|--|--|
| <br> | <p><b>RIESGO DE APLASTAMIENTO Y CORTE.</b></p> <p><b>Nunca trate de detener la cuchilla de la sierra con la mano o con un objeto que sostenga con la mano.</b></p> |



Podría haber casos en que se permita el acceso a la cámara de la sierra mientras la cuchilla de la sierra se desacelera a una velocidad menor de 5 RPM. Esto es normal y no es causa de alarma. No fuerce la cuchilla para que se detenga.

2. Pruebe que el interbloqueo de la PUERTA DE LA CÁMARA DE LA CARRERA/ELEVACIÓN funcione realizando este procedimiento:

|  <b>CAUTION</b>   |   |
|--|---|
| <br> | <p><b>RIESGO DE APLASTAMIENTO Y CORTE.</b></p> <p><b>Antes de encender el equipo, asegúrese de que todo el personal y el equipo estén alejados.</b></p> |

- a) Abra la puerta de la cámara de carrera/elevación (vea las páginas OP-112 y OP-113).
- b) Asegúrese de que el circuito del botón pulsador del freno de emergencia no esté acoplado (no hay botones pulsadores del freno de emergencia activos).
- c) Trate de mover manualmente el ángulo, la elevación o el eje de la carrera (consulte las instrucciones en el paso 1 de la página OP-43).
  - El eje NO debe moverse mientras una puerta esté abierta.
- d) Si se mueve un eje mientras la puerta está abierta, realice los procedimientos de bloque/etiquetado en la sierra y pida a un técnico de servicio calificado que repare el equipo.

## Zona restringida

|   |   |
|---|---|
|  | <p style="text-align: center;"><b>⚠ DANGER</b></p> <p>Manténgase alejado de la zona restringida cuando el equipo esté en uso. Pueden producirse lesiones graves o incluso la muerte si el personal está en la zona restringida.</p> <p>Siempre observe que no haya personal en la zona restringida antes de operar el equipo.</p> |
|---|---|

## Conocer la zona restringida

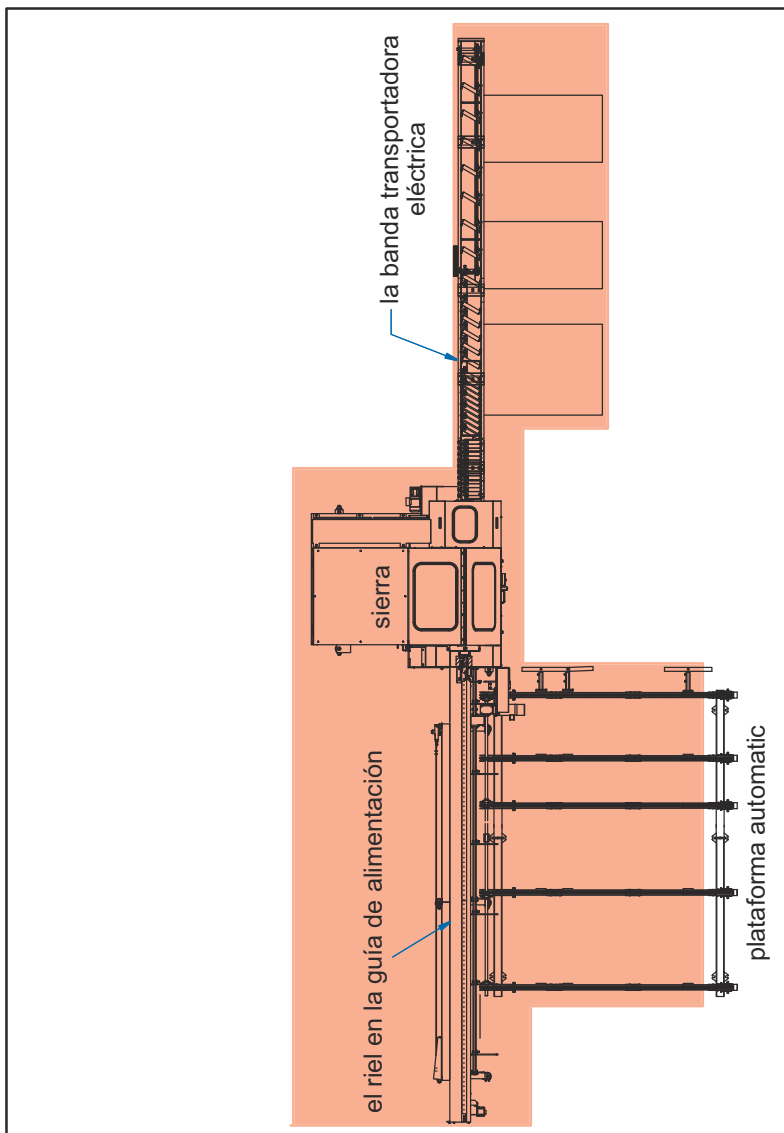





## Marcar la zona restringida

Deberá marcarse la zona restringida de manera que todas las personas cerca del equipo puedan ver claramente el área donde pueda existir peligro.

MiTek ofrece la cinta de zona restringida o “Restricted Zone Tape”, fácil de aplicar y con texto en inglés y en español. Algunos equipos traen la cinta de zona restringida. Si su máquina no trajo la cinta de zona restringida, puede pedirla a MiTek Machinery Division Customer Service (Servicio al cliente de la división de maquinaria de MiTek).

Puede encontrar las instrucciones sobre dónde y cómo aplicar la cinta de zona restringida en el manual de su mesa o pórtico incluido con su sistema o pedir el Service Bulletin Kit 181 en la página web de MiTek Machinery.

## Información adicional

Para entender el circuito del freno de emergencia  
(*Understanding the E-Stop Circuit*)

página  
MT-123



Definiciones de los símbolos de seguridad  
(*Safety Symbol Definitions*)

página  
SAFETY-19

### Purpose of Chapter

This chapter explains how to navigate through the equipment manual and how to contact MiTek.

## Introduction to the Manual

|  <b>WARNING</b> |  |
|--|--|
|                 | <p><b>Read this manual completely before using this equipment!</b></p> <p><b>Do not operate this machine until you have a thorough understanding of all controls, safety devices, emergency stops, and operating procedures outlined in this manual.</b></p> <p><b>All hazard instructions must be read and observed. Failure to do so may result in economic loss, property damage, and/or personal injury.</b></p> <p><b>This manual must always be available to personnel operating and maintaining this equipment.</b></p> |

## Purpose and Scope of This Equipment Manual

In order for this Equipment Manual to be useful, it must be accessible. It is structured so the Operation Manual can be kept at the machine and the Maintenance and Installation Manuals can be kept somewhere accessible by maintenance personnel only.

This manual addresses the most recent versions of the date on the title page. For earlier revisions, contact MiTek Machinery Division.

This manual can be a valuable tool for training.

- The *Introduction* and *General Information* chapters contains information on truss terminology and provides basic information about the equipment.
- The *Operation Manual* teaches operators how to efficiently operate the machine.
- The *Maintenance Manual* is written specifically for maintenance personnel.
- The appendices provide valuable training materials and technical information.

**Figure 1-1: Overview of System**



## Understanding This Manual

### The Equipment Manual (or Manual Set)

This equipment manual is a set of three (3) books. The part number for the entire set is 001080. The manuals listed in Table 1-1 are all part of the equipment manual (also called the manual set).

The page numbers include a prefix so it is clear in which book a page can be found when using cross-references. The Safety (SAFETY) and Introduction (INTRO) sections have their own prefix because they are found in all three books.

**Table 1-1: Manual Set**

| Manual Title                   | Page # Prefix | Description  | Part #    |
|--------------------------------|---------------|--|-----------|
| Book 1:<br>Operation Manual    | OP            | Includes operation procedures and defines the control user interface   | 001080-OP |
| Book 2:<br>Maintenance Manual  | MT            | Includes preventive maintenance, repair maintenance, troubleshooting, parts list, drawing set list, and glossary | 001080-MT |
| Book 3:<br>Installation Manual | IN            | Includes requirements prior to installation, installation procedures, and startup procedures.                    | 001080-IN |

Review the table of contents to understand the structure of the chapters and appendices.

### The Drawing Set

The drawing set is included with this manual set. A list of the drawings can be found in the Maintenance Manual. The actual drawings are either in a separate 11x17 binder or in the back of the Maintenance Manual.







### Screen Shots

See page OP-73 for software versions that the screen shots were taken from.

## Navigation

The graphics in Table 1-2 are used throughout the manual to quickly communicate a specific type of information.

**Table 1-2: Navigational Tools Used Throughout the Manual**

| Graphic   | Explanation   |
|---|---|
|    | Important safety note!<br><br>Indicates that you must lockout/tagout at the disconnect switch located on the equipment using approved methods described in OSHA 29 CFR 1910.147 before continuing with the procedure. |
|    | Indicates tools required before beginning a procedure.  |
|    | Provides additional information for the steps or text.  |
|  | Indicates how to get to or from the item discussed.   |
|  | Refers reader to another section, table, graphic, or drawing for further explanation.   |
|  | Indicates that the part number is listed in the <i>Parts List</i> appendix.   |

## Formatting Cues

To follow the procedures in this manual, you must first understand the text formats used. Table 1-3 describes how to read the cues provided in this text.

**Table 1-3: How to Read the Text Formats**

| If Text Looks Like...        | It Indicates...  | Example in Text               |
|------------------------------|--|-------------------------------|
| All caps                     | Key on keyboard or button on screen                          | Press ENTER                   |
| Initial cap and italic       | Menu or field or virtual button that you must find or select | Click on the <i>File</i> menu |
| Initial cap only, no italics | Menu or field or virtual button when simply referring to it  | While in the Main Menu        |
| Plus sign (+)                | Hold buttons at the same time                                | CTRL+ALT+DELETE               |
| Greater Than sign (>)        | Next selection   | <i>File&gt;Open</i>           |

## Additional Resources

### Supplemental Documentation

In addition to the equipment manual, refer to the documentation provided by the original manufacturer for the parts that are listed in this section. The supplemental documentation is provided at the time of installation, or it may be found inside an electrical enclosure. Refer to these documents when you need more detailed information on these components than the MiTek manual provides.

There is a plastic bag or a box of material sent with each system. It includes a collection of paperwork detailing the technical components used in the system that are manufactured by a different company. Inside this collection you will find spare internal fuses for the servo amplifier.

### Board Stretcher Software Manual

*Board Stretcher* software is an optimizing software independent of the *BLADE* equipment, but it integrates closely with the *BLADE* for the most efficient lumber usage. This manual mentions items that may appear to be controlled by the *BLADE* software but are actually controlled by *Board Stretcher*.

To obtain the *Board Stretcher* manual, each *Board Stretcher* operator should register on *MiTek University™* for the *Board Stretcher* training class. The Training Manual that accompanies the class is the official *Board Stretcher* manual. Once the class is complete, the attendee can always log back on and download or print the manual. Color copies may be requested from the *MiTek University* staff.

### Web Site

Visit the MiTek Web site for up-to-date information on all MiTek equipment.

## Contacting Us

For technical assistance or to order parts, contact the Machinery Division Customer Service Department using one of the methods listed in Figure 1-2.

**Figure 1-2: Contacting MiTek**

**MiTek Machinery Division**  
Customer Service Department  
301 Fountain Lakes Industrial Drive  
St. Charles, MO 63301

**Parts Orders (with part number)**  
E-mail: [mitekparts@mii.com](mailto:mitekparts@mii.com)

**Technical Assistance**  
Phone: 800-523-3380  
Fax: 636-328-9218  
[machinerysupport@mii.com](mailto:machinerysupport@mii.com)

**Web Site**  
[www.mitek-us.com](http://www.mitek-us.com)



### Purpose of Chapter

This chapter provides step-by-step instructions as well as information to help you understand how your equipment works to enable you to make repairs and perform preventive maintenance.

## Introduction to Maintaining Your Equipment

This manual contains sufficient information for proper maintenance under most conditions. Certain operating environments may necessitate preventive maintenance at more frequent intervals. Because consistent preventive maintenance is so important for keeping mechanical equipment in good operating condition, MiTek recommends that you stock certain replacement parts to minimize downtime.

Review the table of contents and utilize the index to locate the information you need. The following appendices will also assist in maintaining and repairing your equipment:

- Troubleshooting
- Parts List
- Maintenance Checklists
- Drawing Set

Refer to pages MT-64 through MT-66 for an overview of component locations that may require maintenance during the life of your equipment.

Read the *Performing Maintenance Safely* section before beginning maintenance on this equipment.





## Performing Maintenance Safely

Read the safety section starting on page SAFETY-1 and adhere to all rules and guidelines. This section provides additional safety information specific to maintenance topics.

### Before Operating This Equipment

Adhere to these warnings before operating this equipment:

|   |   |
|---|---|
|  | <p style="text-align: center;"><b>⚠ WARNING</b></p> <p><b>ELECTROCUTION, HIGH PRESSURE, CRUSH, AND CUT HAZARDS!</b></p> <p>Read this section <b>AND</b> the safety section in the preliminary pages before operating or maintaining this equipment.</p> <p>Do not operate this machine until you have a thorough understanding of all controls, safety devices, E-stops, and operating procedures outlined in this manual.</p> <p>Read and observe all hazard instructions. Failure to do so may result in economic loss, property damage, and/or personal injury.</p> <p>This manual must always be available to personnel operating and maintaining this equipment.</p> |
|---|---|

|   |  |
|---|--|
|  | <p style="text-align: center;"><b>⚠ WARNING</b></p> <p><b>CRUSH AND CUT HAZARD.</b></p> <p>Guards must always be in place during operation to avoid serious injury and possibly death.</p> <p>Always replace guards after maintenance is complete and before removing the lockout/tagout device.</p> |
|---|--|

|   |  |
|---|--|
|  | <p style="text-align: center;"><b>⚠ WARNING</b></p> <p><b>CRUSH AND CUT HAZARD.</b></p> <p>Before turning on the equipment, make sure that all personnel and equipment are clear.</p> <p>When an E-stop is released, the load arms on the Infeed Rail may automatically raise with high force.</p> |
|---|--|







## Lockout/Tagout



The lock and tag symbol shown to the left indicates that proper lockout/tagout procedures must be used prior to starting the procedure where the symbol occurs.

See page OP-117 in the *Operations Manual* for lockout instructions.

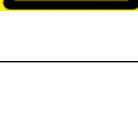
|  <b>WARNING</b> |   |
|--|---|
|                 | <p><b>ELECTROCUTION AND HIGH PRESSURE HAZARDS.</b></p> <p>Always turn the power off by activating an E-stop when the equipment is not in operation.</p>   |
|                 | <p>Always verify that all power to the machine has been turned off and follow approved lockout/tagout safety procedures (OSHA 29 CFR 1910.147) before performing any maintenance on this equipment.</p>                   |
|                | <p>If it is absolutely necessary to troubleshoot an energized machine, follow NFPA 70E or the governing regulations at your location for proper procedures and personal protective equipment.</p>                         |
|               | <p>The components on this machine can cause severe injury if adjusted improperly. Follow all procedures in this manual and do not make adjustments to the machine without guidance from MiTek or MiTek documentation.</p> |
|               | <p>Only trained personnel should make mechanical adjustments to this machine.</p>   |



## Important Safety Information

### Your Responsibilities

Detailed descriptions of standard workshop procedures, safety principles, and service operations are not included in this manual. Although this manual contains some warnings and cautions against specific service methods which could cause personal injury or damage to the machine, it does not cover all conceivable ways of service that might be done or the possibility of hazardous consequences of each conceivable way. If you intend to handle, operate, or service the unit by a procedure or method not specifically recommended by the manufacturer, first make sure that such a procedure or method will not render this equipment unsafe or pose a threat to you and others.

It is the responsibility of the mechanic performing the maintenance or service on a particular machine to:

1. Inspect the machine for abnormal wear and damage.
2. Choose a procedure which will not endanger his/her safety, the safety of others, the equipment, or the safe operation of the machine.
3. Fully inspect and test the machine and the pneumatic and electrical systems to ensure that the service to the machine has been properly performed and that the machine, pneumatic, and electrical systems will function properly.
4. Ensure only qualified electricians perform electrical service work.

|   |   |
|---|---|
|   |  <b>WARNING</b>            |
|  | <p><b>This machine contains high-voltage electricity that may cause serious personal injury or death.</b></p> |

### General Service Rules



1. The design may change or upgrades may occur for any particular component. Always contact the factory before replacing components.
2. If inspection or testing reveals evidence of abnormal wear or damage to the machine, or if you encounter circumstances not covered in the Equipment Manual, STOP and consult MiTek. The machine must be repaired and serviced according to the current specifications and procedures of MiTek. Replacement parts must have properties equal to or greater than those specified by MiTek.
3. Always install new gaskets, O-rings, cotter pins, etc., and place *Loctite* on bolts, if required.



4. Torque bolts and fasteners to the correct specifications.
5. Clean parts in a nonflammable or high-flash-point solvent only.
6. Lubricate any sliding surfaces before assembly.
7. Many components are manufactured from high carbon, heat-treated steel. Do not attempt to cold straighten, hot straighten, bend, or weld these components, as they may fail under load, causing serious personal injury or death.
8. After re-assembly, check all parts for proper installation and operation before putting the machine back into service.
9. It is beneficial to record all major maintenance and testing. This allows recurring problems to be predicted and addressed before any production time is lost. Typical reports and records should include:
  - Date
  - Serial number of machine
  - Description of problem or symptoms
  - Corrective action taken
  - Parts required
10. MiTek will, from time to time, mail out Service Bulletins and updates for this machine. Follow the Service Bulletins and updates accordingly and file them in this equipment manual.
11. The keyholes in the stroke/elevation door lock and the saw chamber door lock are intended for maintenance personnel to override the door interlock for emergency or troubleshooting purposes only. Using the key allows the door to open without electrical power. The maintenance office should store the key in a safe and secure location. Two keys for each door (total of 4 keys) were delivered during installation or startup.

## Making Adjustments and Replacing Parts







Be careful when making mechanical adjustments. Untrained personnel may damage the machine or cause harm to themselves and others.

|  <b>WARNING</b> |  |
|--|--|
|                 | <p><b>CRUSH AND CUT HAZARDS.</b></p> <p><b>Always replace guards after servicing.</b></p> <p><b>Only qualified maintenance personnel shall repair, remove, or replace guards and safety devices.</b></p> |

| <b>NOTICE</b>   |  |
|---|--|
|  | <p><b>Failure to follow the step-by-step procedure may result in incorrect adjustment of this machine and could cause incorrect setups. Only trained personnel should make mechanical adjustments to this machine.</b></p> <p><b>Use the exact replacement parts that are specified.</b></p> |



Special materials have been used for some of the components of this equipment. It is critical to the future performance of this machine that only specified replacement parts are used. Order all replacement parts through MiTek. Do not substitute parts without first consulting MiTek to determine if it is safe and effective. No electrical system component, cable, connector, or device should be modified, removed, disconnected, or changed without specific approval and guidance from MiTek.

## Wearing Personal Protective Equipment

|   |  |
|---|--|
|   |  <b>WARNING</b>   |
| <br><br><br><br><br> | <p>Follow OSHA guidelines to utilize the proper personal protective equipment (PPE) while performing maintenance. The most common include eye protection, hearing protection, dust masks while blowing off sawdust, gloves while working with solvents or blades, and fire retardant clothing when troubleshooting an energized machine.</p> |

## Conducting Safety Tests

Ensure safety devices are always operating properly. Perform the safety tests beginning on page SAFETY-11 before operating the equipment at the initial startup, after performing any maintenance, and according to the maintenance schedule.

|   |  |
|---|--|
|   |  <b>WARNING</b> |
|  | <p><b>Perform safety tests after performing any maintenance on this equipment!</b></p>             |

## Overview Graphics

Figure 2-1 through Figure 2-7 provide an important overview of the equipment to help you better understand the procedures in the *Maintenance* chapter.

**Figure 2-1: MatchPoint BLADE Wood Processing System**



**Figure 2-2: MatchPoint BLADE Saw**





Figure 2-3: Auto Deck as Part of a *MatchPoint BLADE* Wood Processing System



Figure 2-4: Powered Skewed Conveyor as Part of a *MatchPoint BLADE* System  
(optional equipment)



Figure 2-5: Major Components Visible From the Left Side of Saw

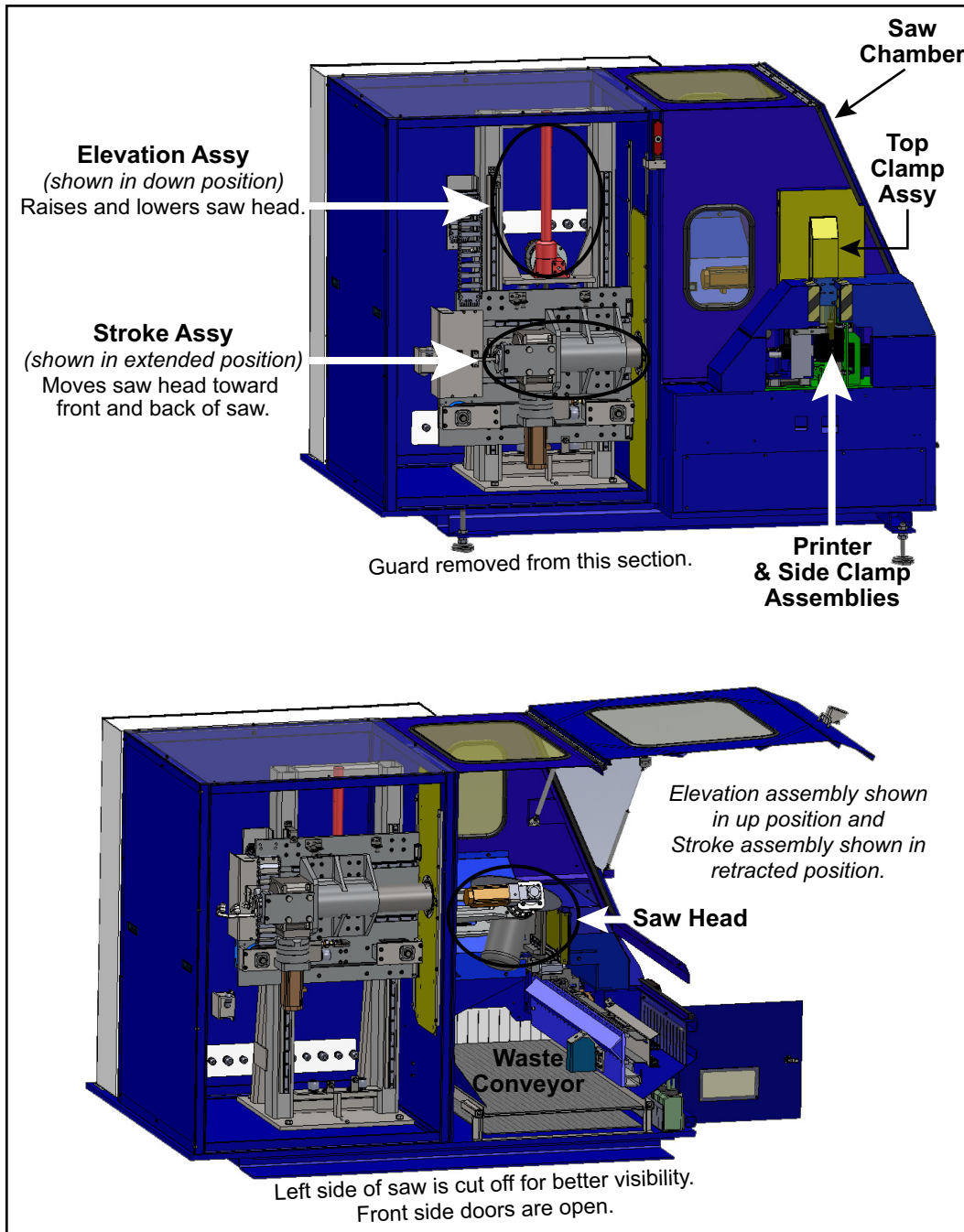



**Figure 2-6: Major Components Visible From the Front of Saw**

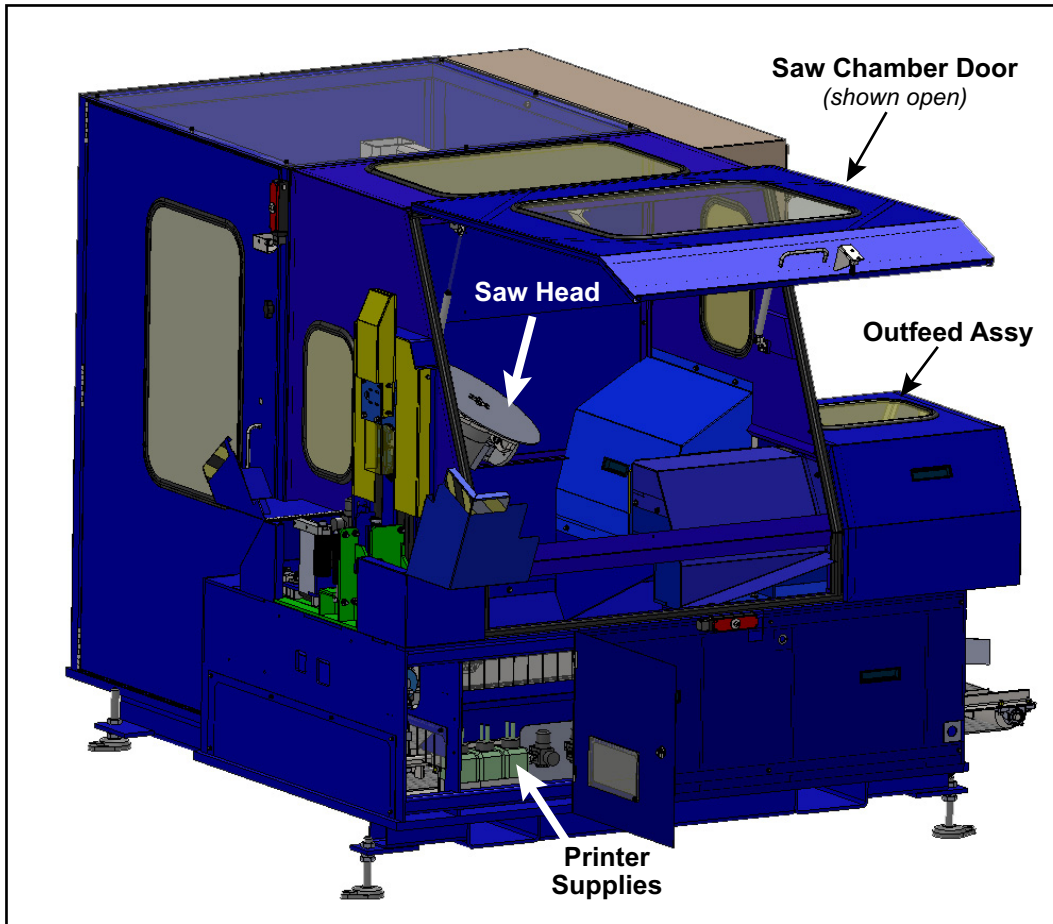
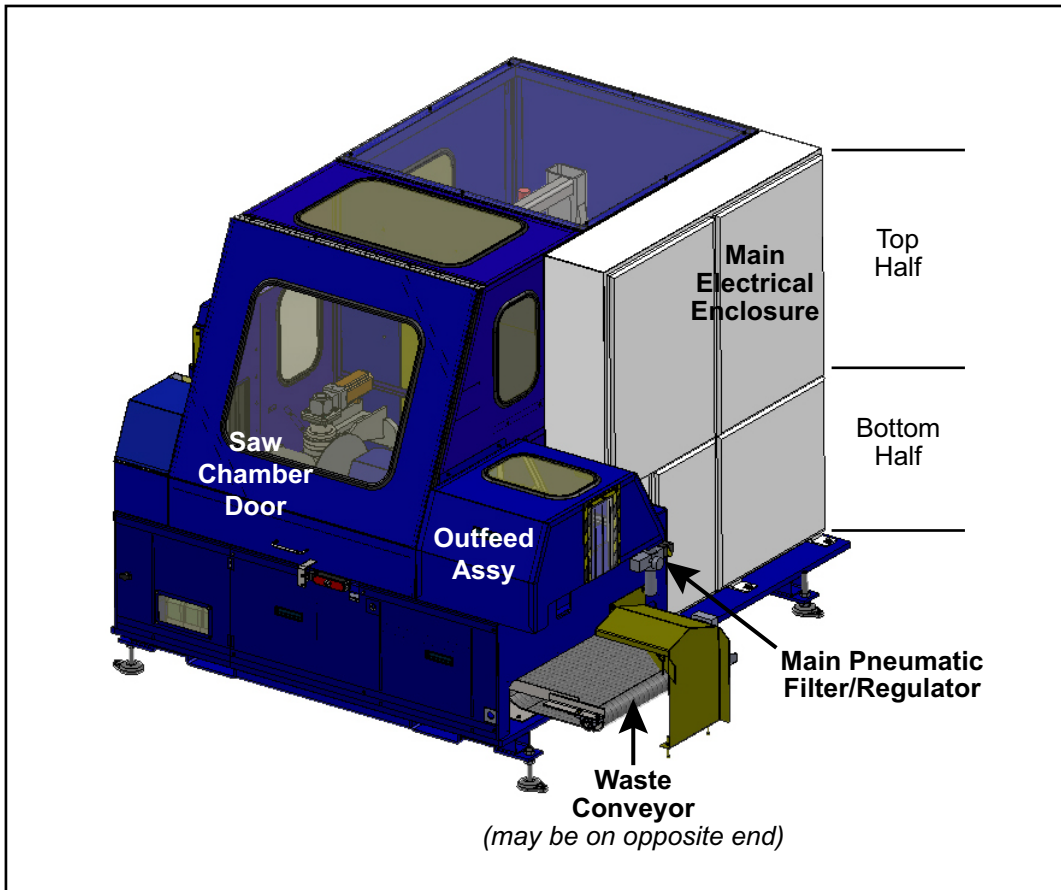

Figure 2-7: Major Components Visible From the Right Side of Saw



## SECTION 1: PARTS AND PROCEDURES

### Calibration

#### Homing the Gripper, LASM, and Stroke

*Currently affects only the gripper, LASM, and stroke axes!*

The primary reason the home position may become compromised and needs to home itself is that a jam in any given axis may cause the motor collar to slip. The motors are designed to let this happen to avoid costly damage. By automatically homing itself, occasional slips are planned for and dealt with automatically. But, if the saw is experiencing a high number of out-of-calibration instances on a certain axes, the root cause must be determined and fixed. If the saw reads 4 or more slippages on the same axes within an hour, it gives the following error: [The \(axis name\) servo has mechanically slipped many times in a short duration. The Online Support button will display a web page with information on how to eliminate this issue.](#) Online Support is accessible from this error, from the saw's Home Screen, and from our web site.

The counts do not reset at 4, but continue to count up within any 60-minute time frame. Online Support describes all the points to check on each axis. Table 1 describes the method used to track each axis position and the accuracy required.

**Table 1: How Positions are Tracked**

| Axis    | Measures Inaccuracies | How it Tracks Position  |
|---------|-----------------------|---|
| Gripper | >3/32"                | Reads where trailing edge of board passes beam of Leading Edge Sensor (receiver/transmitter pair on front end of Infeed Rail), and beam reconnects.   |
| LASM    | >1/16"                | Uses LASM Lockout Sensor (also called No Fly Zone sensor) to tell when LASM is directly in front of blade (if blade is at 90 deg). As LASM moves toward outfeed side and passes sensor, position is captured. |
| Stroke  | >1/16"                | Uses Home Sensor on retract motion to capture position.   |

#### Calibrating the Angle, Bevel, Elevation, and CLS

Refer to page OP-141 in the Operation Manual for basic calibration procedures. This section provides additional technical details to assist maintenance personnel with troubleshooting.

## Cleaning and Inspecting

To clean or inspect the equipment, disconnect the unit from its power source first.



### Cleaning Debris and Dust Off the Machine

It is important to blow off the equipment daily. Saw dust acts as an insulator and will prevent electrical components from working properly, and debris causes mechanical jams.

| <b>NOTICE</b>   |   |
|---|---|
|  | <p><b>Never use compressed air inside the electrical enclosures! It may force contaminants into the electrical connections.</b></p> <p><b>Use a vacuum to remove dust from electrical enclosures. Canned air is acceptable after vacuuming.</b></p> |

#### **BLOW OFF...**

- Top and sides of saw frame
- Auto Deck chains
- Infeed rail where board travels
- Gripper assembly, behind gripper assembly, and board slip sensor
- Sensors on Infeed Rail near saw end
- Inside top/side clamp assembly
- Outfeed clamp, lumber channel, behind outfeed clamp at cylinder
- Inside stroke/elev chamber; all axes
- Remove lumber scraps and anything that doesn't belong on equipment surfaces & belts, and blow off surfaces

#### **VACUUM...**

- Inside electrical enclosures:  
**NEVER USE COMPRESSED AIR!**
- Floor of stroke/elev chamber
- Floor of saw chamber
- Saw chamber, especially around blade and LASM (cover the Crooked Lumber Sensor under LASM to protect from saw dust)
- Floor under and around system

### Wiping Off the Machine

Do not use liquid cleaners, aerosols, abrasive pads, scouring powders or solvents, such as benzine or alcohol. After blowing dust off, use a soft cloth lightly moistened with a mild detergent solution to wipe off the equipment. Ensure the surface cleaned is fully dry before reconnecting power.

## Cleaning the Printer

If ink or cleaner makes contact with a person's skin, hair, eyes, or clothes, refer to the treatment section on page MT-28 in the *Safety (English)* section.



Small brush  
Cleaner fluid  
Washing station

Follow this procedure carefully to clean the print heads correctly. Failing to follow these instructions will push debris into the print head and shorten its life. When a print head is damaged by dust and debris, it may require replacing the entire print head which is a costly solution.

| <b>NOTICE</b> |  |
|---------------|--|
|               | <p>DO NOT use a cloth rag because it will push debris into the print head nozzle including cloth lint.</p> <p>A brush was provided with your new printer. It may be helpful to trim the ends of the bristles to make them shorter, and therefore, stiffer.</p> <p>Keep the brush in a ZIPPED plastic bag. If the bag or the brush get contaminated between uses, wash it or replace it.</p> <p>Do not use other cleaning solutions! Cleaning this ink requires 100% acetone, and the Matthews cleaner has been specially formulated to dissolve the Matthews ink. Other cleaners may contain additional ingredients that will damage the printheads.</p> <p>Do not spray the cleaner on. The spray can push debris into the nozzles.</p> <p>Always store extra bottles of cleaner in a temperature-controlled area. When opening a bottle near the saw, set the bottle and cap on a clean and dust-free surface.</p> |



Clean the printer face (nozzles) at least **twice a day** with this procedure:

1. Dip the brush in the cleaner used in the printer assembly (for flushing print heads).
2. Lightly move the brush back and forth across each nozzle, ensuring that all visible traces of ink are gone each time.
3. Rinse the brush immediately to remove ink before it dries.
4. Place the brush in a plastic bag and seal the plastic bag.



### Refer to...

These instructions are also in the *Printer* appendix in the *Operation Manual* with additional maintenance requirements.

| <b>CAUTION</b> |  |
|----------------|--|
|                | <p><b>Wear goggles and gloves when handling ink/cleaner.</b></p> <p><b>Never wash ink or cleaner in a location where food or dishes may be. Rinse area well when done.</b></p> |

**Flushing the Printer: See page OP-177 in the Operation Manual.**

## Cleaning Electrical Components

### General Cleaning of Electrical Components

It is recommended to cover electrical components with a clean rag before doing any maintenance that will disrupt existing dust.

| <b>NOTICE</b>   |   |
|---|---|
|  | <p><b>Never use compressed air inside the electrical enclosures! It may force contaminants into the electrical connections.</b></p> <p><b>Use a vacuum to remove dust from electrical enclosures. Canned air is acceptable after vacuuming.</b></p> |

### Cleaning Motor Starter Contacts

Motor starter contacts may need to be cycled to force contaminants out. If you suspect a motor starter contact has dirt in it, use these steps:

This procedure can be used on all motor starter contacts EXCEPT on the red safety contacts shown in Figure 2-8.

1. Activate an E-stop. The starter will release (open) and the dust may fall out.
2. Release the E-stop, press RESET, and attempt to operate the equipment.
3. If the problem continues, activate an E-stop again, and lockout/tagout at the equipment power source.
4. Use canned air to blow dust from contacts. **DO NOT USE PNEUMATIC AIR FROM YOUR PLANT!**
5. Cycle the contacts up and down with a small screwdriver.
6. Vacuum the enclosure.

**Figure 2-8: Do NOT Clean These Safety Contacts**



**Figure 2-9: Clean These Contacts**

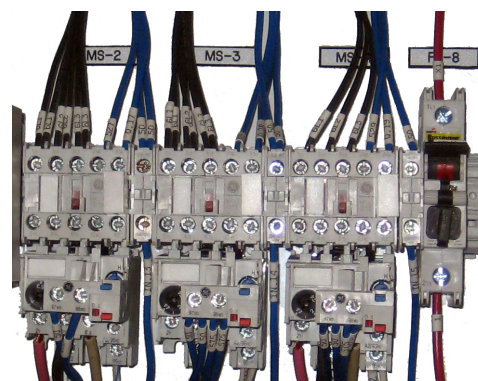

## Periodic Inspection



This inspection should periodically be done by maintenance personnel. A facility manager should determine the frequency of this inspection, but it must be done at least once a year to ensure the equipment will continue to operate safely.

1. Wipe down all metal surfaces with a mild cleaner.
2. Inspect all safety and operation labels for legibility.
3. Inspect all safety devices, ensuring they are intact and working.
4. Thoroughly clean the pneumatic filter sludge.
5. Check entire system for loose hardware.
6. Check for leaks at all motors, bearings, gearboxes, etc.
7. Blow out all motor vents.
8. Inspect all sprockets, replacing any that do not rotate easily.
9. Check all chains and belts for excessive wear and proper tension.
10. Measure the LASM fixed jaw. It must be at least 1-1/2" thick. See Figure 2-30 on page MT-113.
11. Inspect and vacuum all electrical enclosures and junction boxes. Check for loose wires.
12. Sweep and mop the area surrounding the equipment, being careful not to spray water directly in an electrical enclosure.



## Lubricating

Proper amounts of motor oil and grease must be maintained at all times. The type of lubrication used, frequency of application, oxidation, and contamination of the lubricant affect service life and parts efficiency of gears and bearings. Follow the guidelines in this manual to obtain improved performance.



Grease points are shown on page MT-73 and motor locations are shown on page MT-74.

There are synthetic fluids, synthetic blends, and hydrocarbon fluids (mineral). With these lubricants, special consideration must be given to the seals, pump performance, paints, and any plastics in the system. In addition, the viscosity of synthetic fluids and synthetic blends is usually much lower than the viscosity of hydrocarbon (mineral) based fluids.

### Overview of Lubrication Points

Lubrication guidelines are given in this chapter in the section for each part or system that requires lubrication. The information is also in the *Maintenance Checklist* appendix.

| NOTICE   |  |
|--|--|
|  | <b>Mixing synthetic lubricants with mineral lubricants is not recommended. Check with your lubricant supplier.</b> |



Use #2 lithium-based grease for all grease applications mentioned in this manual.

**Table 2-1: Cross-Reference Guide to Lubrication Information**

| Component                  | See Page...  |
|----------------------------|--|
| Chains                     | There are no chains on this equipment that need to be lubricated regularly.  |
| Motors and Gearboxes       | Refer to the <i>Motors and Gearboxes</i> section starting on page MT-73 for motor oil and gearbox lubrication information. Motor locations are shown in Figure 2-10 on page MT-74. |
| Linear Guide Rails         | Refer to the <i>Linear Guide Bearings</i> section starting on page MT-89 for the lubrication procedure.  |
| Elevation Jack Screw       | Refer to page MT-96 for lubrication instructions and specifications.   |
| Auto Deck                  | Refer to page MT-107.  |
| Outfeed Clamp Camfollowers | Refer to the <i>Lubricating the Outfeed Clamp Camfollowers</i> section on page MT-115.   |
| Waste Conveyor             | Refer to page MT-124.  |
| Powered Skewed Conveyor    | Refer to page MT-130.  |



## Motors and Gearboxes

### Maintenance and Location of Motors/Gearboxes

Certain preventive maintenance is required to keep the motor and gearbox in optimal working order. Table 2-2 lists all motors on the system and page MT-74 shows their locations.

**Table 2-2: Detailed Maintenance Information for Motors**

| Motor                   | Motor Specs          | Gearbox (if present) | Requires Grease? (1x/year) | Requires Oil?  | Brake?   |
|-------------------------|----------------------|----------------------|----------------------------|----------------|----------|
| Auto Deck               | 3/4 hp               | Nord gearbox         | yes                        | see page MT-75 | no       |
| Powered Skewed Conveyor | 1 hp                 | Boston gearbox       | see page MT-131            | no             | no       |
| Lumber Exit Chain Drive | 1/2 hp               | Nord gearmotor       | yes                        | see page MT-75 | no       |
| Waste Conveyor          | 1/2 hp               | Nord gearmotor       | no                         | see page MT-75 | no       |
| Blade                   | 5 hp                 |                      | yes<br>(2 fittings)        | see page MT-96 | no       |
| Angle                   | servo                |                      | no                         | no             | internal |
| Elevation               | servo w/brake        |                      | yes                        | no             | external |
| Infeed Drive            | servo w/gear reducer |                      | no                         | no             | no       |
| Stroke                  | servo w/gear reducer |                      | no                         | no             | no       |
| LASM                    | servo w/gearbox      |                      | no                         | no             | no       |
| Bevel                   | Bevel gearbox        |                      | yes                        |                | no       |
|                         | GAM gearbox          |                      | no                         | no             | no       |

Figure 2-10: Motor Locations

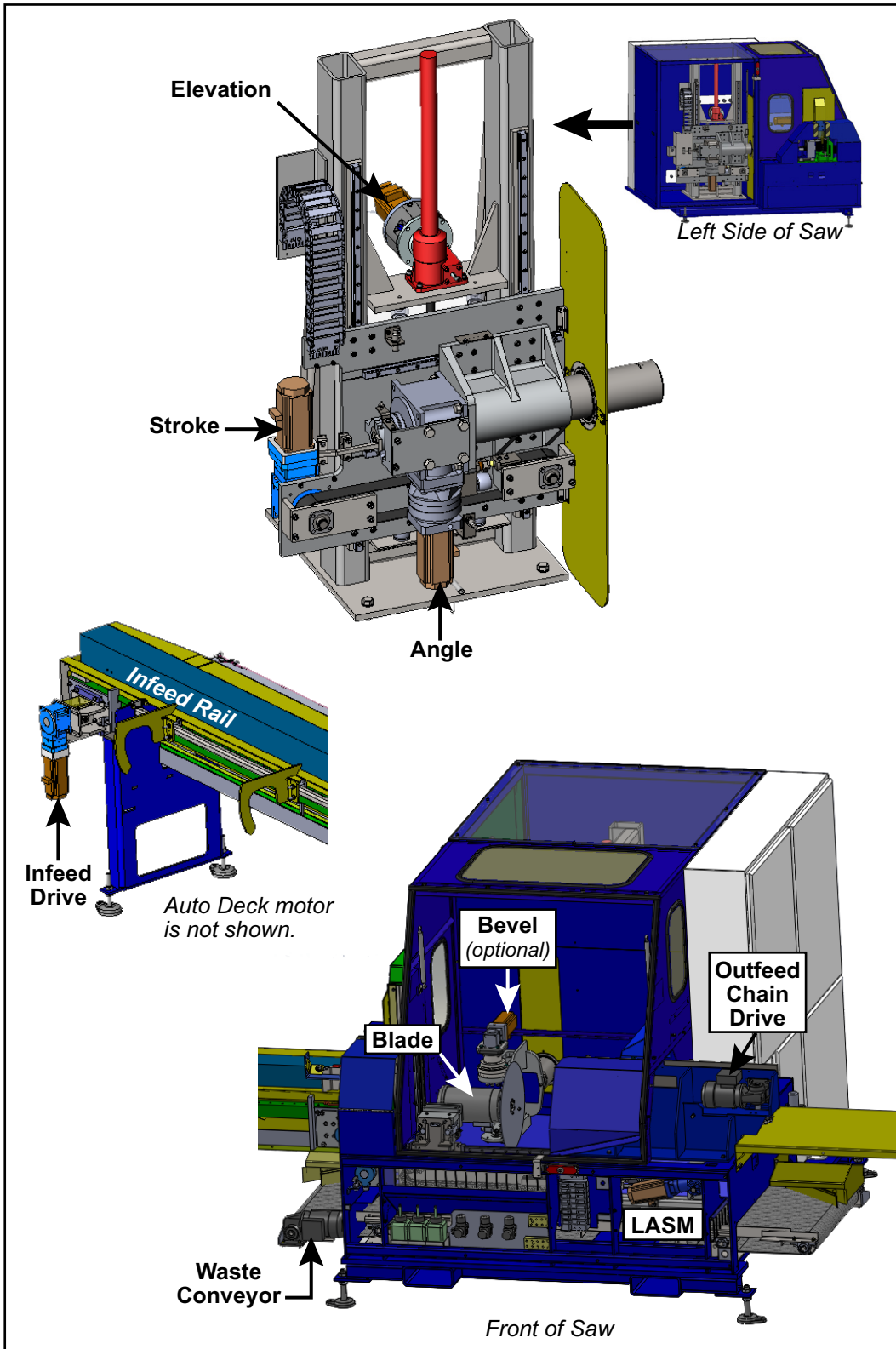

## Filling and Replacing the Lubrication Level

Periodically check the oil in all the motors/gearboxes that are indicated on page MT-73. Many of the gearboxes are sealed for life and do not need the oil to be filled or replaced. For motors/gearboxes that need oil, fill with an oil recommended in Table 2-3 as needed.

### Nord Gearboxes Only

When additional oil is needed in a motor/gearbox, use one of the oils recommended in Table 2-3 for Nord motors.

**Table 2-3: Recommended Motor Oil for Nord Motors**

|                |   |
|----------------|---|
| ISO VG         | 220 mineral oil   |
| Brand and Type | Manufacturer filled with <i>Mobil</i> SHC 630 (non-synthetic) |



Motor locations shown on page MT-74.

### Replacing the Oil in Nord™ Gearboxes

For Nord brand motors/gearboxes, replace the oil as indicated:

- Standard oil: 10,000 hours or 2 years (whichever comes first)
- Synthetic oil: 20,000 hours or 4 years (whichever comes first)

When it is time to replace the oil in a Nord motor/gearbox, follow these steps:

1. Completely drain the oil by removing the drain plug. On Nord motors, it is a metric socket-head cap screw.
2. Screw the drain plug back in place.
3. Remove the fill level plug and add new oil through the opening. On Nord motors, the fill level plug is a hex head cap screw.





- grease
- hex socket set
- grease nipples and grease gun
- torque wrench
- seal tape
- rags

## Adding Lubrication to *Nabtesco*™ Gearbox (Bevel Axis)

### Lubrication for *Nabtesco* Gearbox

Recommended grease: VIGOGREASE RE0™

- Operating temperature range (ambient): 14°F to 104°F (-10 to 40°C)
- Reservoir volume: Approximately 219 grams
- This is a synthetic EP lithium grease sold by *Nabtesco*. If substituting a different grease, work with your supplier to ensure it is equivalent.
- Replace every 20,000 working hours

### Lubrication Procedure

The bevel gearhead has a *Nabtesco* gearbox and a GAM gearbox (PN 410281). The GAM gearbox is sealed, but the *Nabtesco* gearbox requires lubrication. Follow these instructions for lubricating the *Nabtesco* gearbox.

1. Rotate and position the output shaft of the reduction gear so that the tapped holes for injecting/draining grease are located diagonally as shown in Figure 2-11.
2. Lockout/tagout all power.



|                  |   |
|------------------|---|
| <b>⚠ CAUTION</b> |   |
|                  | <p><b>LET COOL BEFORE UNPLUGGING HOLE!</b></p> <p>If a tapped hole for injecting/draining grease is unplugged while the reduction gear is still hot, hot lubricant sprays out, which could cause burns.</p> |

3. Drain and add grease following these steps:

**Figure 2-11: *Nabtesco* Gearhead Hole Identification**

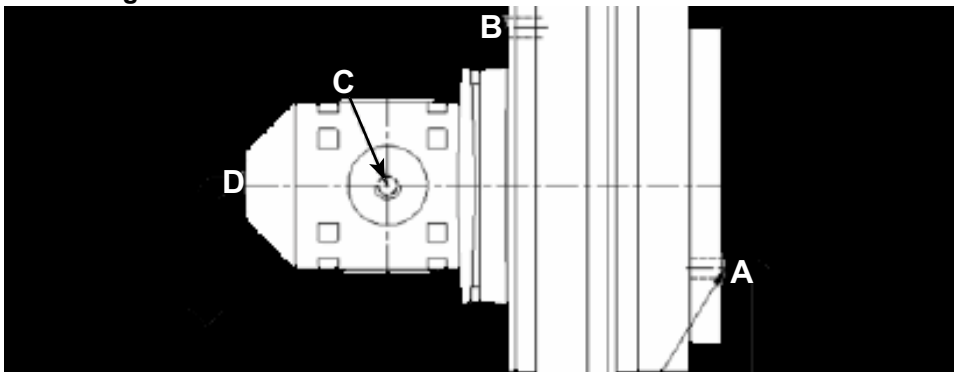

- a) Unscrew the hexagon socket head cap plugs and other parts from holes A and B shown in Figure 2-11.



- b) The exact location of the 2 holes will vary depending on where the shaft stopped rotating. Drain the lubricant from the lower hole.
  - c) Attach a grease nipple to the lower hole, leaving the upper hole open as a vent to protect the seals.
  - d) Add grease until it is visible at the edge of the top hole. The capacity of the reservoir is 219 grams.
4. Use the torque settings listed in Table 2-4 to install the plugs and other parts:

**Table 2-4: Torque Settings for Hole Plugs** (for 020E Model)

| Hole | Parts to Install      | Torque (Nm) |         |
|------|-----------------------|-------------|---------|
| A    | M6 cap screw & washer | 12.1        | +/-0.61 |
| B    | Plug GM-1/8           | 12.3        | +/-2.45 |

- a) Install new seal tape onto the plugs.
- b) Re-install the plugs and other parts that were removed from the holes.
- c) Wipe off the gearbox and surrounding area.

## Slippage Errors and Tightening Motor Couplings

**Figure 2-12: Potential Causes of Gripper Slippage Error**

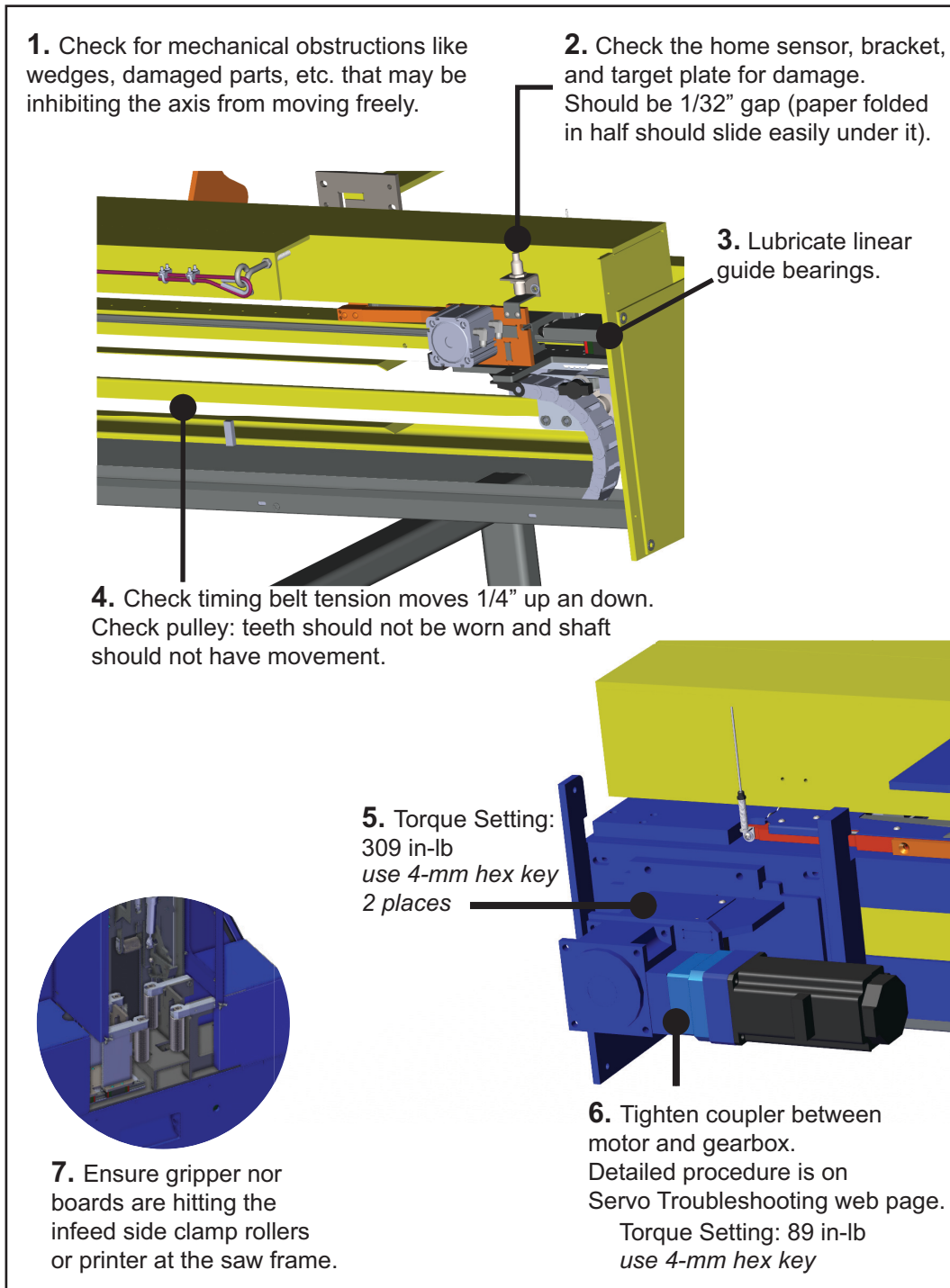

**Figure 2-13: Potential Causes of LASM Slippage Error**

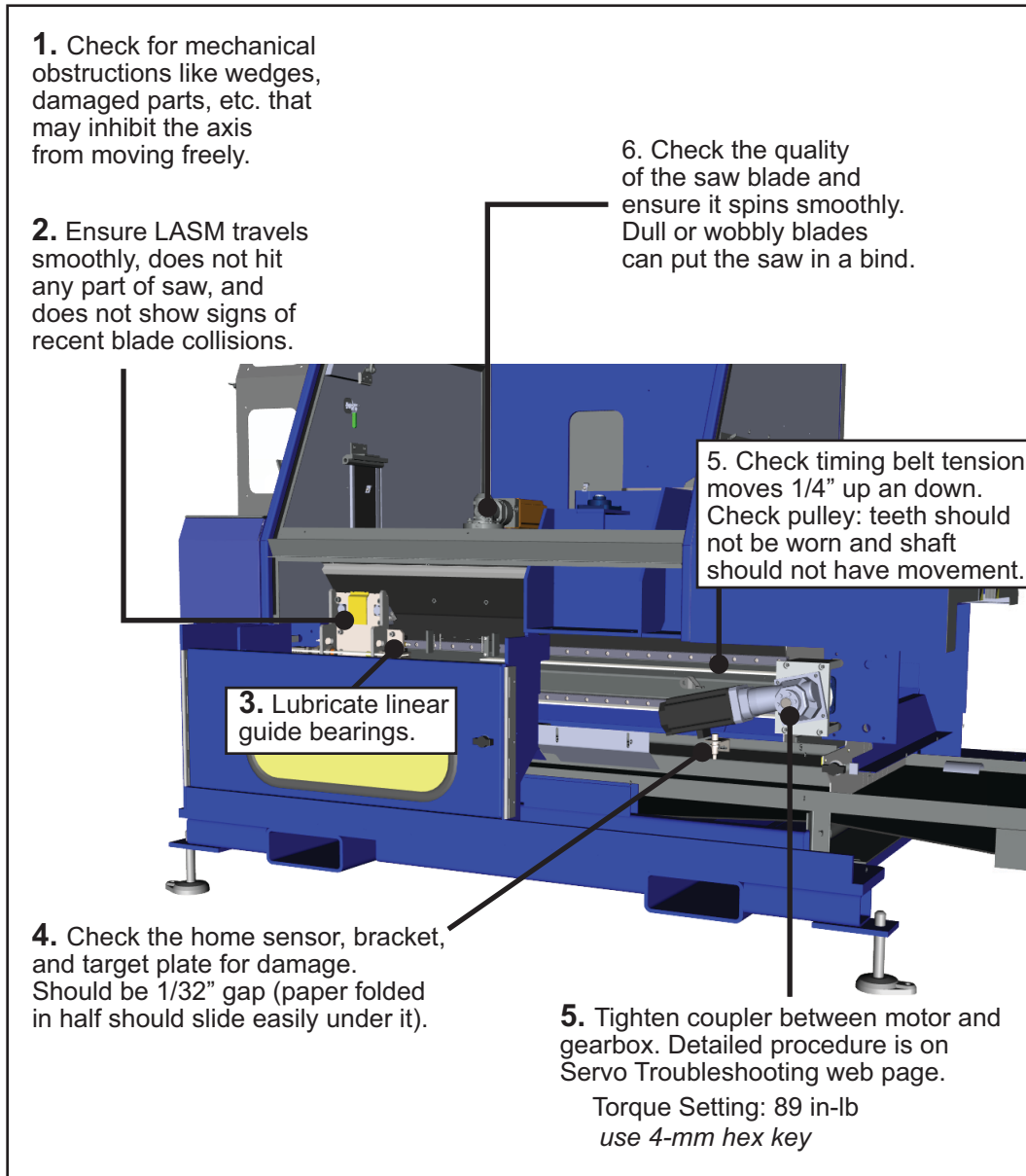

**Figure 2-14: Potential Causes of Stroke Slippage Error**

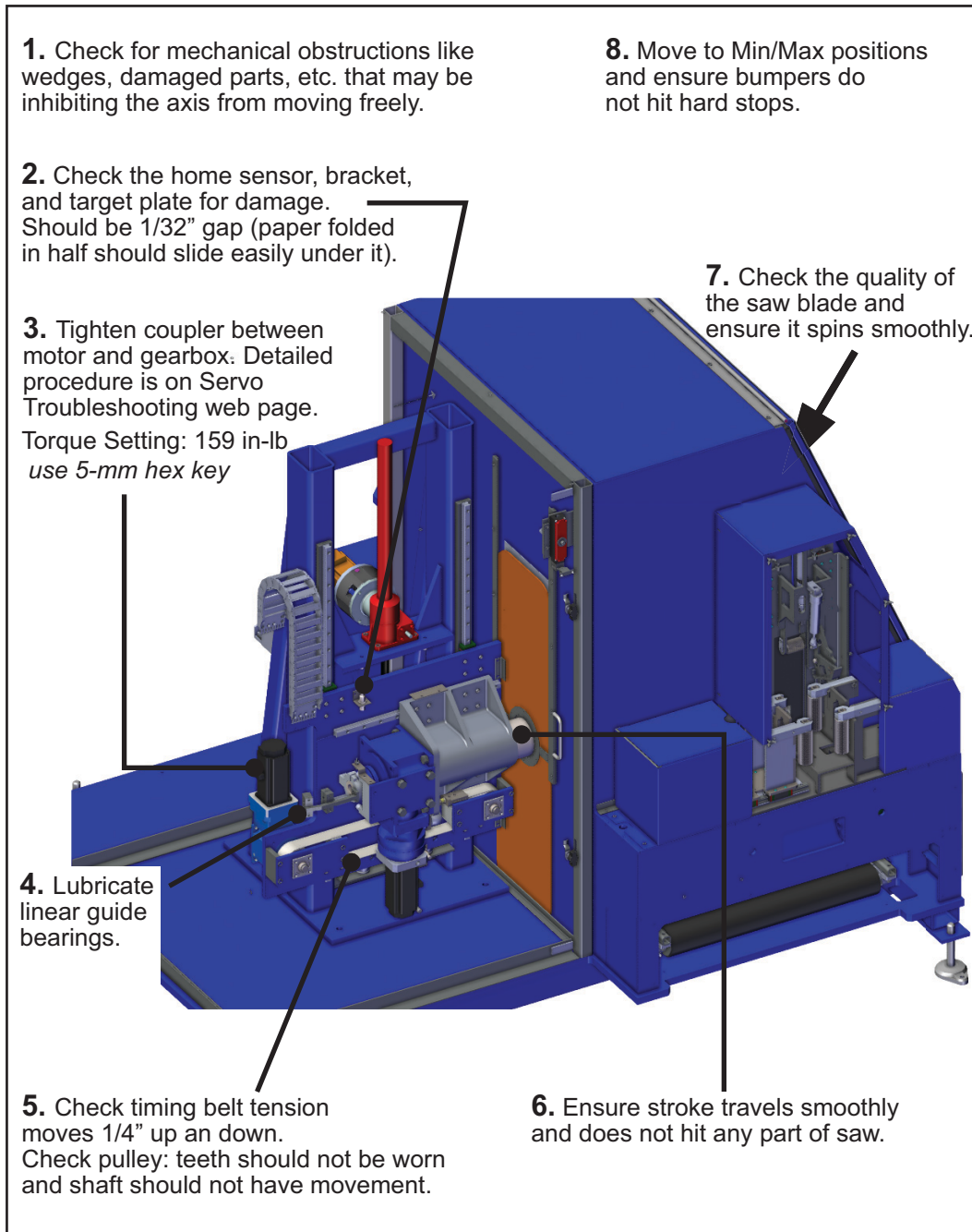



**Figure 2-15: Tightening Motor Coupler on Servo Motors**

**For Gripper Coupling (Output):**

1. Remove the guard to expose the coupling at Output screws.
2. With E-stop actuated, move axis with your hand.
3. Torque both screws.

**For LASM, Stroke, Gripper, and Angle Servo Motors (Input):**

1. Remove the plug labeled INPUT in photo to access the hole.
2. Align the screw with hole by either:

- a) **For LASM, Stroke, and Gripper only:**  
With E-stop actuated, move axis by hand.

OR

- b) **For all 5 axes:**  
With power on, use the Moving to a Position procedure below.

3. Torque the screw to the appropriate setting using a torque wrench and hex key.

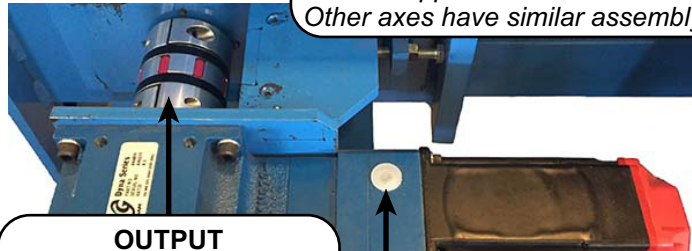

*Gripper motor shown here. Other axes have similar assembly.*

| OUTPUT Hex-Head |            |                 |
|-----------------|------------|-----------------|
| Motor           | Torque     | Socket          |
| LASM            | 44 in-lbs  | 8-mm            |
| Stroke          | 106 in-lbs | 10-mm           |
| Angle           | 106 in-lbs | 10-mm           |
| Allen Wrench    |            |                 |
| Gripper         | 309 in-lbs | 6-mm (2 places) |

| INPUT Allen |           |        |
|-------------|-----------|--------|
| Motor       | Torque    | Wrench |
| LASM        | 89 in-lb  | 4-mm   |
| Stroke      | 80 in-lb  | 5-mm   |
| Beve        | 50 in-lb  | 3-mm   |
| Angle       | 177 in-lb | 5-mm   |
| Gripper     | 89 in-lb  | 4-mm   |

**For Bevel Servo Motors (Input & Output):**

Use the same steps above, but refer to the pictures below.



GAM Output Shaft and Nabtesco Input Shaft Coupling Bolt 120 in-lbs

GAM Input Shaft Coupling Bolt 50 in-lbs

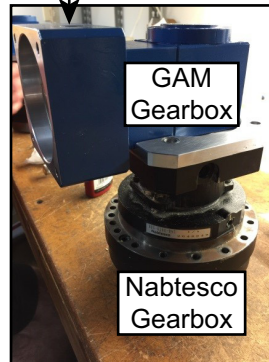

**Moving to a Position:**

Enter small position changes in *Diagnostics>Detailed Diagnostics>Move To Position* fields to move motor coupler in small increments.



## Changing the Rotation of a Motor

This system uses 3-phase power. If a 3-phase motor is rotating in the wrong direction, swap two (2) of the 3-phase wires at the incoming power and test again.

**Figure 2-16: Swap 2 of the 3-Phase Wires to Change Motor Direction on Saw**

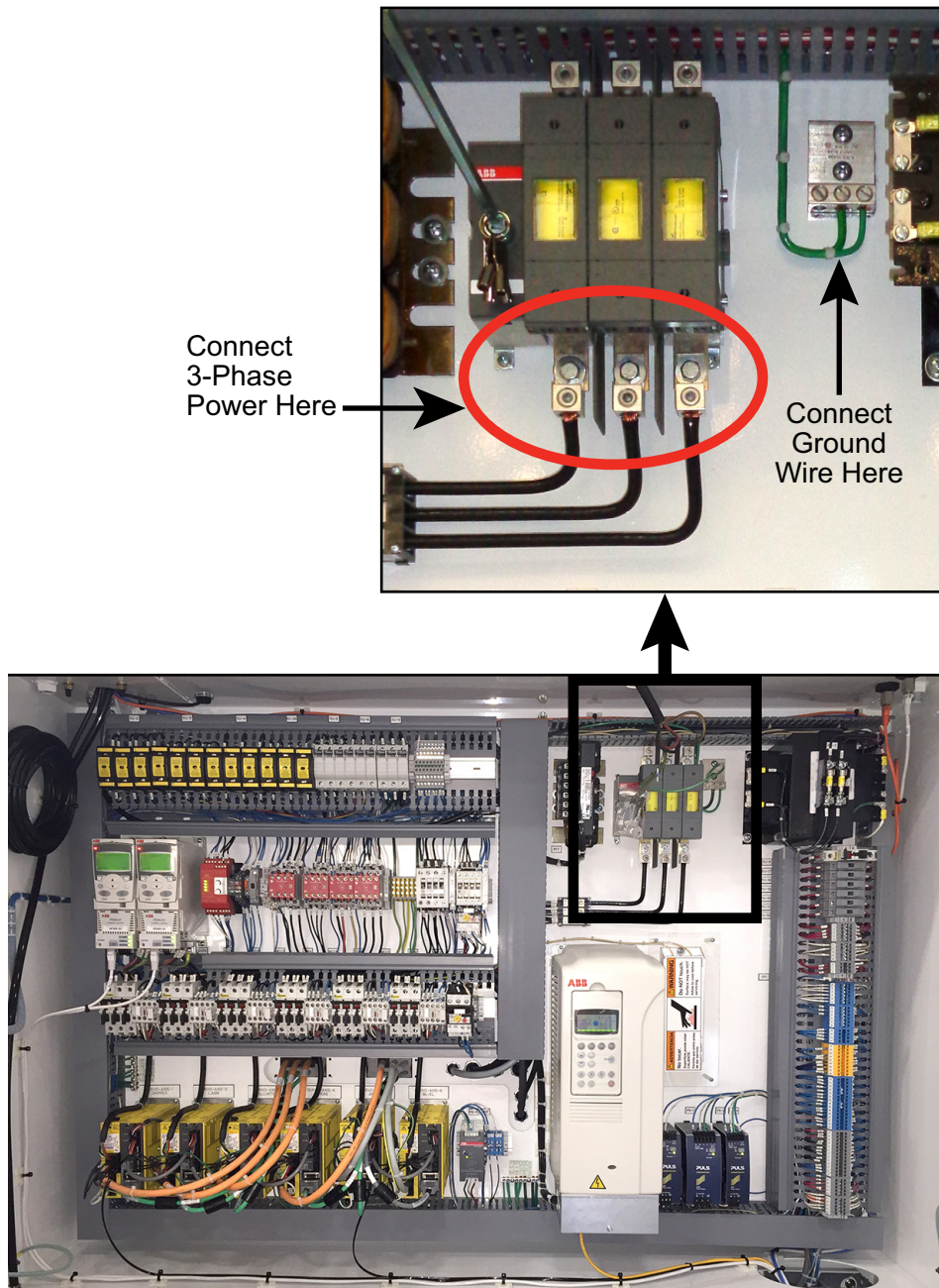

Top Half of Main Enclosure



If the Auto Deck motor is turning in the wrong direction, swap any 2 of the wires shown in Figure 2-17.

**Figure 2-17: Swap 2 of the 3-Phase Wires to Change Motor Direction on Auto Deck**



## Timing Belts



The timing belts in Table 2-5 may need to be tightened or replaced due to normal wear. Instructions can be found later in this section.



For waste conveyor belt maintenance, see page MT-124.

**Table 2-5: Belts and Belt Sizes**

| Belt Name           | Length  |
|---------------------|---------|
| Gripper timing belt | 552 in. |
| LASM timing belt    | 134 in. |
| Stroke timing belt  | 68 in.  |

|  <b>WARNING</b>  |  |
|---|--|
| <br> | <p><b>ELECTROCUTION AND CRUSH HAZARDS.</b></p> <p>Always verify that all power to the machine has been turned off and follow approved lockout/tagout safety procedures (OSHA 29 CFR 1910.147) before performing any maintenance on this equipment.</p> <p>The components on this machine can cause severe injury if adjusted improperly. Follow all procedures in this manual and do not make adjustments to the machine without guidance from MiTek or MiTek documentation.</p> <p>Only trained personnel should make mechanical adjustments to this machine.</p> |



## Gripper Belts

### Adjusting the Gripper Timing Belt Tension



1. Loosen the 4 bolts clamping the gearbox mounting bracket to the frame.
2. Back off the jam nut and turn the tension bolt to wedge the entire infeed drive motor and bracket out until the belts are tight.

Tension should be guitar-string tight, but do not over-tighten. Test the tension at the drive end. The top section of the belt should lift approximately 3/16 in. with little effort.

3. Re-tighten the bolts clamping the bracket to the frame.
4. Move the gripper assembly back and forth (from the touch screen) to test the belt tracking. Adjust if necessary.

**Figure 2-18: Adjusting the Gripper Timing Belt**

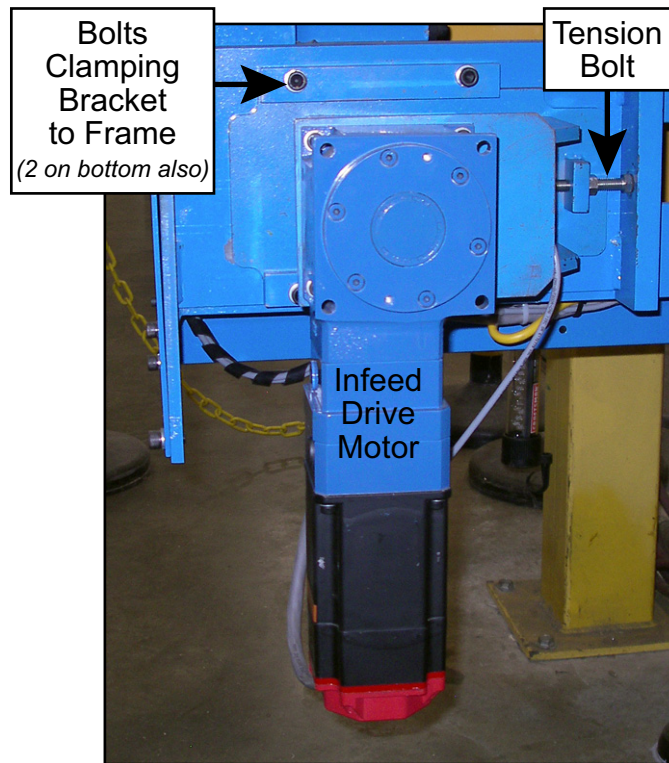

### Removing Top Gripper Assembly

Occasionally, during maintenance of the gripper and belts, you may need to remove the top gripper assembly.



1. Position the gripper assembly so the screws labeled A in Figure 2-19 are accessible.
2. Lockout/tagout.
3. Remove the back panel.
4. Remove the stop bar by removing the 3 socket head screws on top.
5. Remove the 4 flat head screws labeled A.
6. Slide the gripper assembly, following the instructions on page MT-93 to prevent the bearing balls from falling out of the linear guide bearing block.

**Figure 2-19: Gripper and Belt Assembly, View from Back Side**

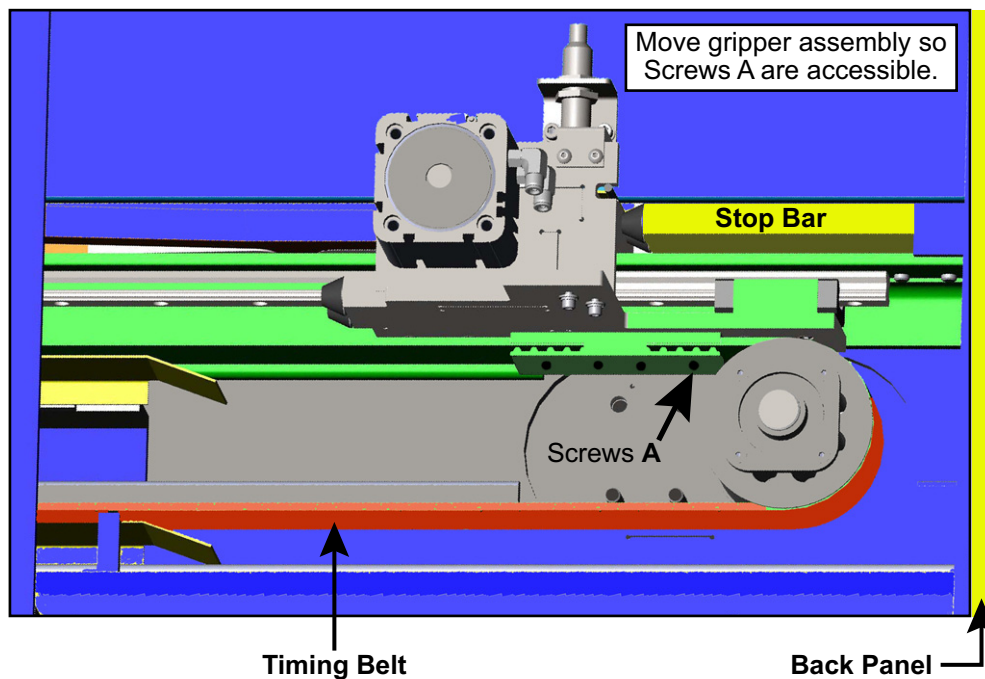

## Manually Turning the Gripper Belt to Find Obstructions

If you need to manually move the gripper to remove an obstruction or troubleshoot, the gripper belt can be jogged from the saw's operator interface.

From the Home Screen, select the *Gripper* indicator and choose one of the Jog options. Move the gripper assembly back and forth to test the belt tracking. Adjust if necessary.



If the gripper becomes difficult to move, refer to the Troubleshooting appendix.

## Adjusting the Gripper Belt Tracking



If the gripper belt is not tracking on the shaft evenly, loosen the tension (see page MT-85) and manually move the belt over to the center of the shaft. Tighten the tension, ensuring that the motor assembly is straight and square. Manually move the gripper to the opposite end of the Infeed Rail to test the tracking. Repeat this process until the belt stays where it was placed on the shaft.

## LASM and Stroke Belts

The LASM assembly and the stroke assembly are each attached to their own cogged, white belt, called a timing belt. To adjust the tension of the LASM or stroke timing belt, perform these steps:



1. Locate the threaded rod used as a tension bolt that puts tension on the timing belt attached to the assembly. The Stroke tension bolt is shown in Figure 2-20. The LASM tension assembly looks similar.
2. Back off the jam nuts and adjust the bolts to tighten or loosen the tension on the cogged, white belt.
3. Tighten the jam nuts.
4. From the saw's Home Screen, select the Stroke or LASM indicator and choose one of the Jog options to move the assembly back and forth to test the belt tracking.
5. Adjust if necessary.

**Figure 2-20: Stroke Timing Belt Tension Bolt, in Stroke/Elevation Chamber**

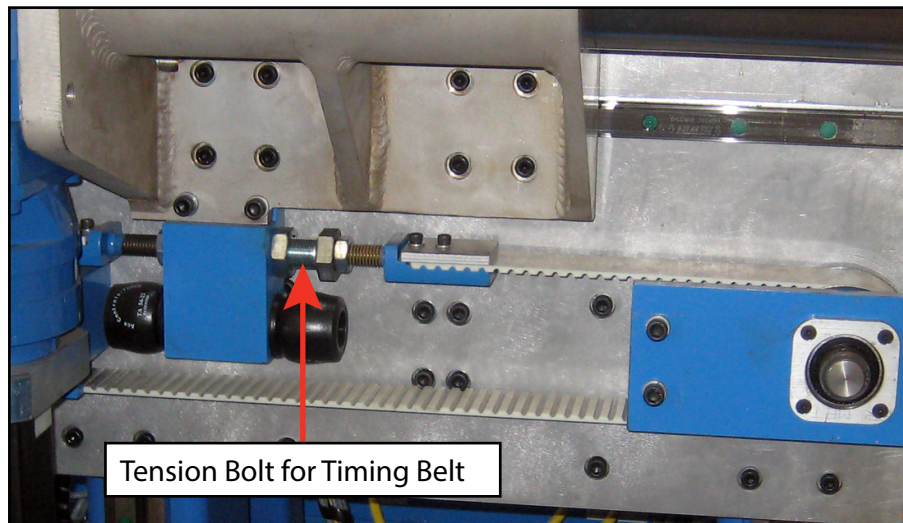



## Linear Guide Bearings



Prior to 2015, oil cartridges were used on the bearings instead of grease fittings. The bearings described here are a direct replacement for those models.

### Lubricating the Linear Guide Bearings

#### Grease Required

##### *Mobilux™ EP 2*

This is a general purpose, lithium-based Grade 2 grease that provides excellent protection against rust and corrosion and resists water wash-out, corrosion protection, low temperature pumpability, and high temperature service life.

| <b>NOTICE</b>   |  |
|---|--|
|  | <p><b>Other Grade 2 greases will not provide the necessary properties at the high temperatures experienced in this application. Use only the recommended grease.</b></p> |

#### Grease Gun Recommended

It is recommended to use the following grease gun to ensure the proper amount of grease is applied. If you do not have this grease gun available for this procedure, it is recommended that you purchase one for future use. These bearings require re-greasing at frequent intervals. Having a policy stating the grease gun and number of pumps to use on each bearing will elongate their life and the accuracy of the saw.

Hiwin GN-80M  
Output: 0.5-0.6 cm<sup>3</sup> per stroke

If you choose to use a different grease gun, document which gun is to be used for this procedure and ensure employees know the output per stroke. The output per stroke should be equal to or less than 0.5 cm<sup>3</sup> per stroke.

#### Modifying Your Grease Gun

It may be difficult to fit the grease gun tip onto the bearing fitting due to limited space around the bearing. To make the greasing process easier, grind down a flat spot on one side of the grease gun tip or machine the outside diameter (O.D.) of the tip down so it fits into the space around the bearing fitting. The outside diameter is shown in Figure 3.

**Figure 3: Grease Gun Tip**

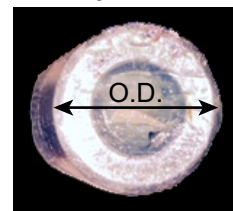

This requirement makes it that much more important to have a grease gun dedicated for this procedure.



Proper grease  
Grease gun  
Lockout/tagout

## Applying Lubrication to the Bearings

Check the quality of the lubrication on the guide rails every week to determine when more grease is needed. The frequency of greasing depends on many factors including amount of use and amount of dust. After enough time has passed to determine a pattern, document how often the bearings should be greased, but continue to inspect the rails every week.

Linear rails using the previously used bearing blocks (that have a reservoir cartridge instead of a grease fitting) should also be inspected each week. Instructions for maintaining those bearings are located in the first release of the BLADE Maintenance Manual, but MiTek strongly recommends replacing them with the current bearing style for the most successful maintenance plan.

For re-greasing the new bearings with the grease fitting:

- Use the volume of grease listed in Table 2-6.
- It is highly recommended to either use the grease gun recommended on page MT-89 or to create an internal procedure stating the exact grease gun that should be used and how many times to pump the gun handle to administer the correct volume of grease.

**Table 2-6: Volume of Grease**

| Applicable Kit  | Grease<br>(not supplied) |
|---|--------------------------|
| LASM, Stroke, & Elevation (size 25)                                       | 0.8 cm <sup>3</sup>      |
| Gripper, Infeed Top Clamp, Infeed Side Clamp, and Outfeed Clamp (size 20) | 0.5 cm <sup>3</sup>      |

| <b>NOTICE</b>   |  |
|---|--|
|  | <p><b>Add grease to these new bearings periodically to ensure saw accuracy and prevent friction from damaging components.</b></p> <p><b>Overgreasing will cause premature failure of bearing seals and excessive saw dust and dirt to stick to the guide rails, negating the benefits of the grease. Undergreasing may cause damage to components and affect the accuracy of the saw. A thin film of grease should be visible on the guide rails at all times.</b></p> |

## Bearing Locations and Quantities

**Table 2-7: Assemblies Lubricated by Linear Guide Bearings**

| Lubricated Assembly | Qty. | Graphic    |
|---------------------|------|------------|
| Infeed Rail Gripper | 2    | not shown  |
| Top Clamp           | 4    | Figure 2-1 |
| Infeed Side Clamp   | 4    | Figure 2-1 |
| LASM                | 4    | Figure 2-2 |
| Stroke              | 4    | Figure 2-3 |
| Elevation           | 4    | Figure 2-3 |
| Outfeed Clamp       | 4    | Figure 2-4 |

**Figure 2-1: Bearing Locations for Infeed Side and Top Clamps**

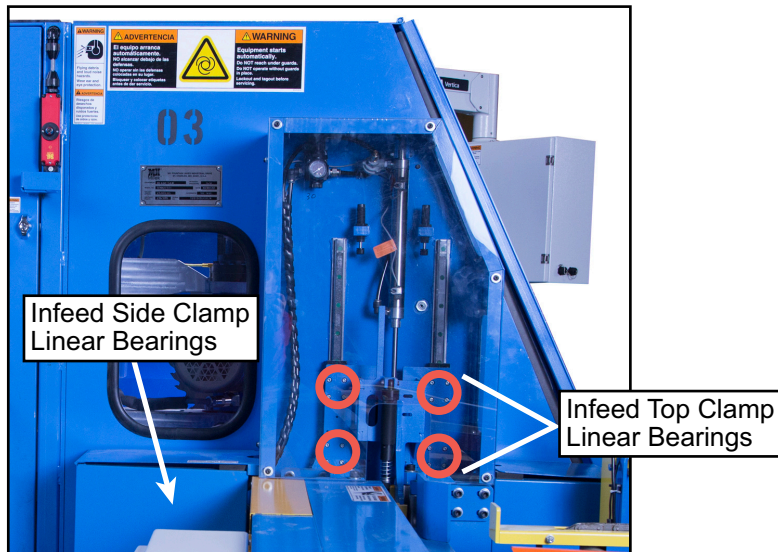

**Figure 2-2: Bearing Locations for LASM**

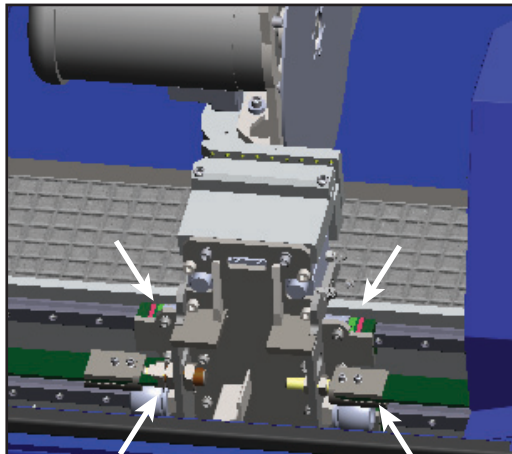

**Figure 2-3: Bearing Locations for Stroke and Elevation**

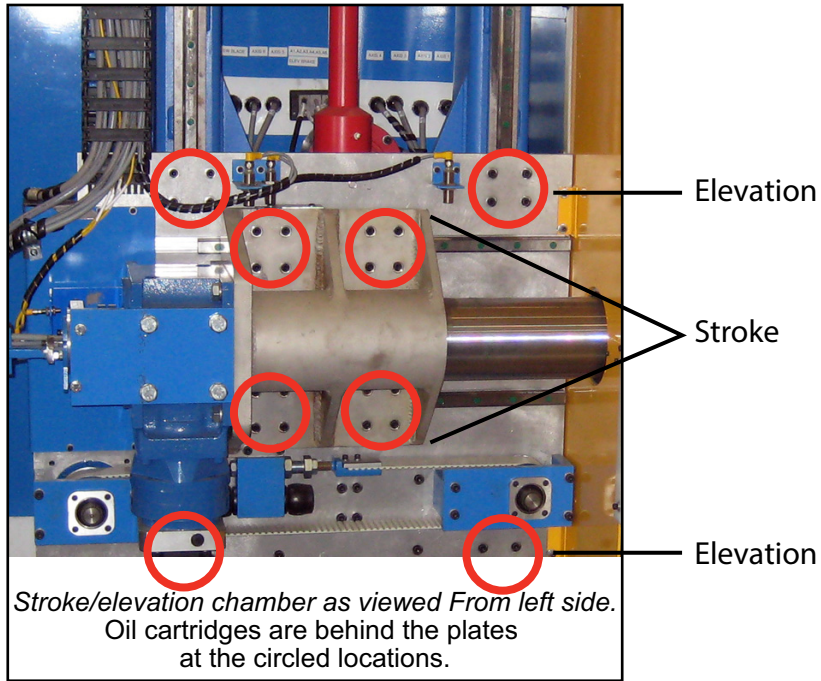

**Figure 2-4: Outfeed Clamp Bearings**

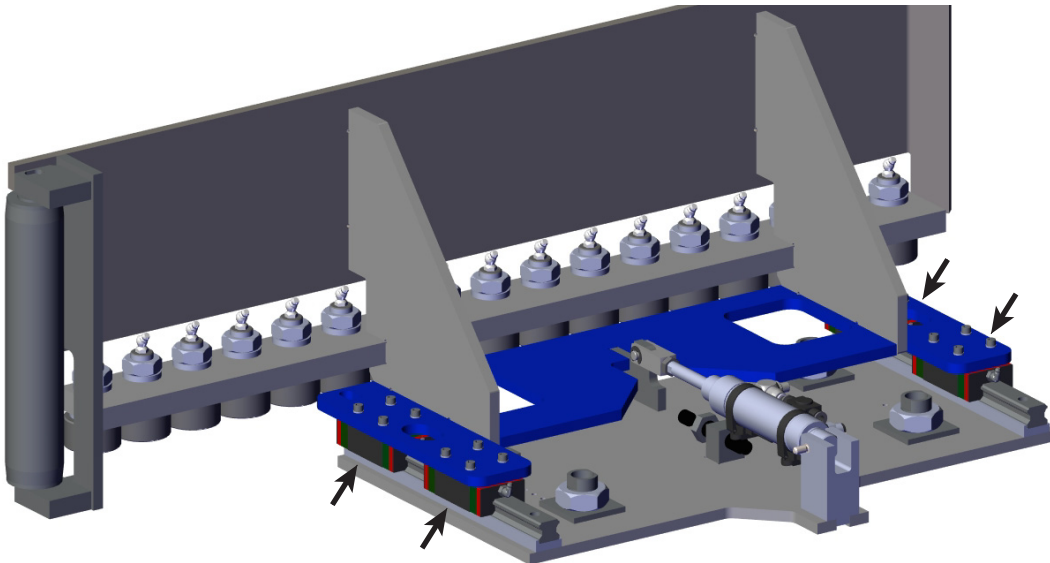

## Replacing a Linear Guide Bearing Block

To replace a linear guide bearing, order the appropriate kit listed in Table 2-8.

**Table 2-8: Parts in SB209 Kits**

| Applicable Kit  | Grease<br>(not supplied) |
|---|--------------------------|
| SB209KIT-A (size 25) for<br>LASM, Stroke, & Elevation                                       | 0.8 cm <sup>3</sup>      |
| SB209KIT-B (size 20) for Gripper, Infeed Top Clamp,<br>Infeed Side Clamp, and Outfeed Clamp | 0.5 cm <sup>3</sup>      |



Hex key wrench  
set (metric)

Proper grease

Grease gun

Lockout/tagout



1. After locking/tagout out, remove the previously used bearing block:
  - a) Unscrew the 4 screws from the plate. Keep the screws to use later.
  - b) Slide the bearing off of the rail. Be sure to keep the bearing level to prevent the ball bearings from falling out.
2. Discard the previously used bearing, but NOT the screws.
3. Examine the new bearing block. The grease fitting must be securely attached to the bearing block. If it is loose in the box, connect it using these steps:
  - a) Clean dust, metal shavings, and oil off the hole threads. Use a standard brake cleaner or anything that removes lubrication.
  - b) Screw the fitting into the bearing block as shown in Figure 2-5. Ensure the fitting is facing a direction that allows it to be easily accessed later. The direction the fitting should face depends on its location on the saw, so visualize its location carefully before installing the fitting.

Figure 2-5: Important Parts of Each Bearing Block

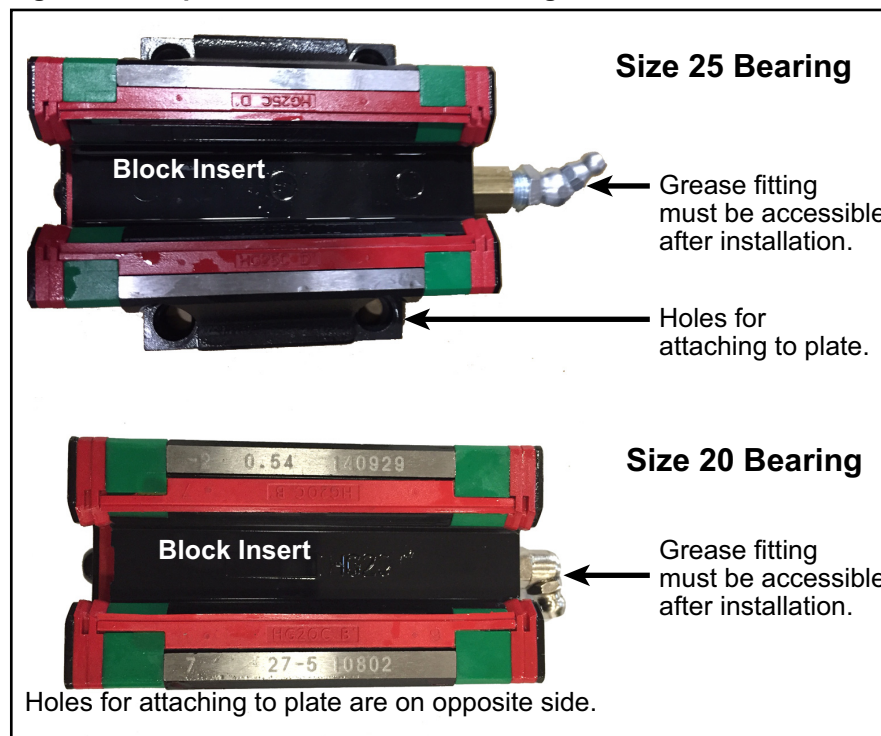

4. Clean oil and debris off of the parts listed below. A standard brake cleaner or anything that removes lubrication will work.
  - a) On the new bearing, with the block insert in place to protect the ball bearings, carefully clean the threaded screw holes. Do not get cleaner in the ball bearing area.
  - b) Clean the screws that were removed from the old bearing block.
5. Install the new bearing block with the fitting facing out, so it will be accessible to grease in the future.
  - a) Slide the bearing block onto its rail, allowing the rail to push the block insert completely out of the bearing block.
  - b) Slide the bearing block down until it is behind the linear guide plate and the holes are aligned.
  - c) Using the screws removed from the previously used bearing block, apply blue *Loctite*™ thread adhesive to each screw, and then screw the plate and bearing block together.



Make sure the grease fitting is pointing out, so it is easily accessible.



- d) Wait 10 minutes for the *Loctite* thread adhesive to dry before moving the assembly.

| <b>NOTICE</b>   |  |
|---|--|
|  | <p><b>Use <i>Loctite</i> thread adhesive to prevent the bearings from coming loose, causing costly machine damage.</b></p> <p><b>The bearings are shipped with NO grease in them. They MUST be greased before operating the saw!</b></p> |

6. After the *Loctite* thread adhesive is dry, apply the correct amount of grease to the fitting.
- The grease volume is listed in Table 2-8 on page MT-93.
  - The correct grease is specified on page MT-89.
  - The grease gun recommended is described on page MT-89.



Overgreasing will cause premature failure of bearing seals and excessive saw dust and dirt to stick to the guide rails, negating the benefits of the grease. Undergreasing may cause damage to components and affect the accuracy of the saw. A thin film of grease should be visible on the guide rails at all times.

7. Remove the lockout/tagout mechanisms.
8. Run the saw for several minutes, then lockout/tagout again and look at the rail. Check to see if a lubricant film can be seen on the rail. If not, add more grease.

## Elevation Jack Screw

The elevation jack screw raises and lowers the saw head. It requires the following lubrication:



Apply grease to the 2 fittings on the jack screw housing every 3 months using a standard grease gun.



Use XHP222 Mobil grease for both grease fittings.

## Saw Blade Motor



The saw blade motor has 2 grease fittings that must have #2 lithium-based grease added at least once a year. See page MT-75 for saw blade motor oil information.

Figure 2-6: Lubrication for Elevation Jack Screw

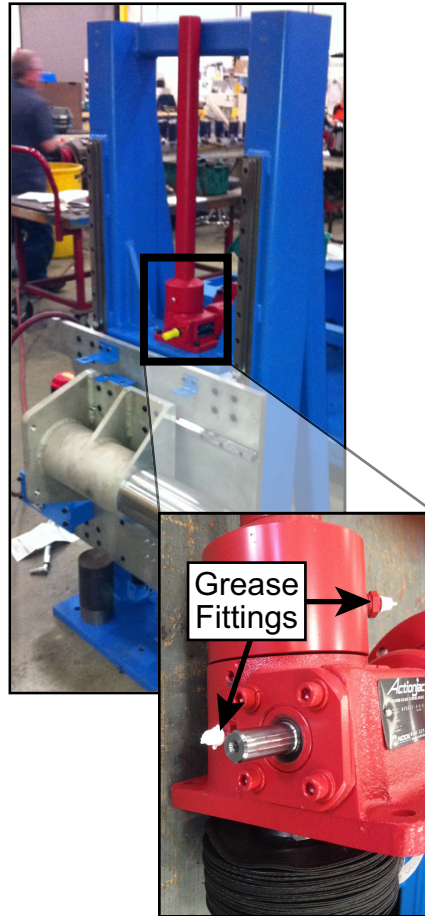



## Saw Blade

### Direction of Blade Teeth

The saw blade rotates toward the operator, traveling down when the blade is in home position (Angle at default 90 degrees). Screws must be torqued correctly. See page MT-99.

### Specs for New or Used Saw Blades

#### When Retipping Blades

The following specs are critical:

- 17" = blade diameter
- .189" = kerf
- Z = # of teeth
- 10.5° = hook angle
- 0° = face angle
- 15° = back angle
- 10° = top angle

Figure 2-7: Saw Blade Assembly



#### For New or Used Saw Blades

Throw away saw blades with less than 16-5/8" diameter.



### When to Replace the Saw Blade

Replace the saw blade on the saw at least once a week.

The frequency of blade changes and of repairs depend on the amount of use and the species and grade of lumber, as well as the number of hours the saw is running each week. Your plant may need to change the blade more often for optimum saw operation.



To replace the blade motor cable, see page MT-170.

|   |   |
|---|---|
|   |  <b>WARNING</b>  |
|  | <p><b>Check torque on blade screws daily and whenever there is visible vibration of the saw blade.</b></p> <p><b>Keep saw blades sharp and in good condition. Have the saw blade re-tipped if carbide tips become chipped or come off. Dull blades cause high kickback forces which can cause injury.</b></p> <p><b>Use new screws, matching the specs provided, each time a blade is replaced.</b></p> |

## How to Replace the Blade

|   |   |
|---|---|
|  <b>CAUTION</b>  |   |
|   | <p><b>CUT HAZARD.</b></p> <p><b>Saw blades are sharp. Wear gloves and eye protection when handling blade.</b></p> |



1. Gather the following supplies:



- a) New or sharpened saw blade.
  - For a new saw blade, order SB202KIT from MiTek.
- b) Correct screws (6):
  - Each new saw blade kit comes with a box of 50 screws. Keep the extra screws to reinstall a used blade after sharpening.
- c) Correct Torque wrench and T30 Torx™ driver (also called star or hexalobular internal shaped driver).



2. After ensuring the power is locked out, loosen and remove the screws labeled in Figure 2-8 on page MT-99. Discard the screws.
3. Remove the saw blade and place in a safe place for sharpening or re-tipping.
4. Place a new saw blade so the holes are aligned with the holes in the hub.

|  |  |
|--|--|
|  <b>WARNING</b> |  |
|                 | <p><b>Use new screws every time the blade is replaced.</b></p> <p><b>Do NOT use thread adhesive.</b></p> <p><b>Torque to specifications given in Figure 2-8!</b></p> |

5. Using new screws obtained from MiTek with your last new saw blade purchase, install all 6 screws.

- Use the driver and screws described in step 1.
- Tighten each screw one half turn at a time, alternating between screws in a clockwise order.
- Torque to the specification listed in Figure 2-8 on page MT-99.

To prevent the screws from shearing off, which could result in serious injury, do **not** use thread adhesive.

PN

Use only 1/4"-28x5/8" flat head screws of the same strength and specifications as MiTek SB202KIT supplies.

**Figure 2-8: Torque Specs for Saw Blade and Hub**  
*(View from outfeed side of saw, with blade at 90 degrees.)*

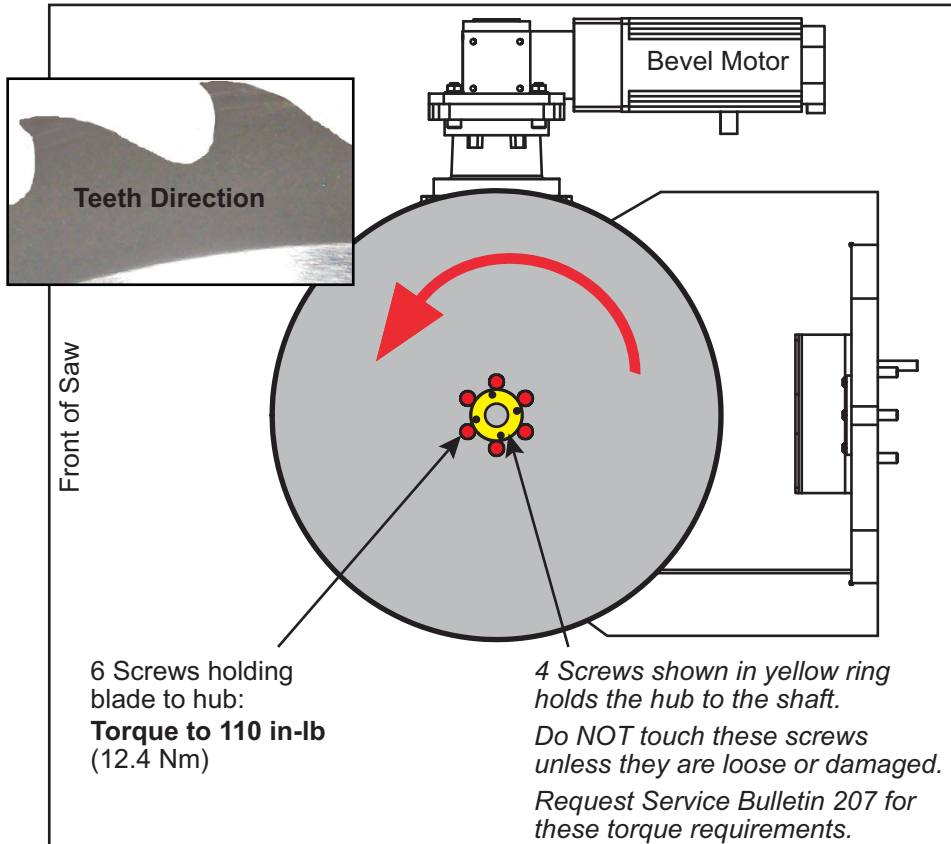

**Figure 2-9: Torque Specs When Replacing Blade Gearbox**

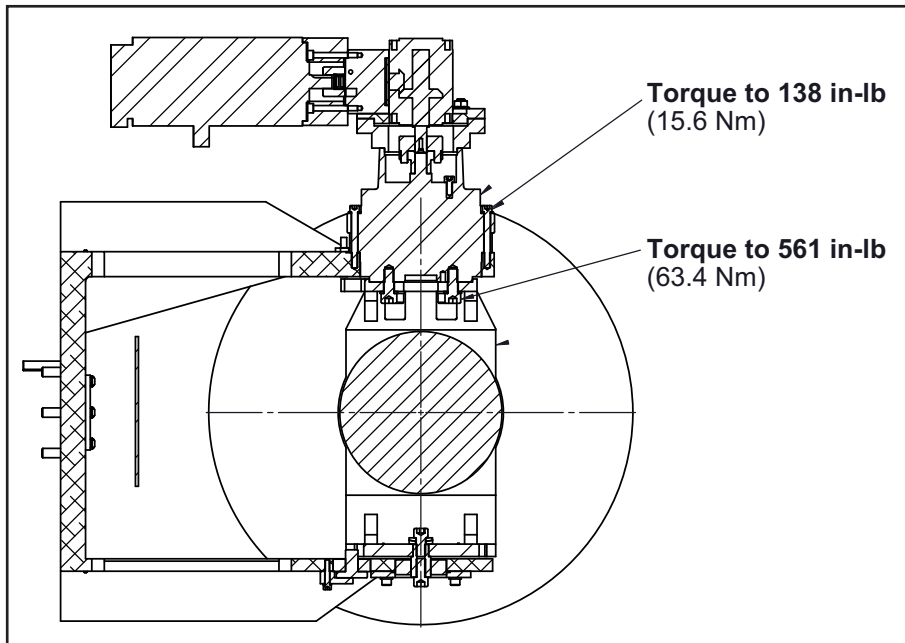

## Felt Strips

Felt strips provide friction resistance for the yellow plate that slides up and down with the elevation axis located inside the stroke/elevation chamber. The felt strips are attached to the blue wall behind the yellow plate. When the plate is showing signs of metal rubbing metal or an uneven plate, replace the felt strips immediately to preserve the accuracy of the cuts and prolong the life of the saw.

### Trimming the Felt

If no metal wear is shown, but the felt has expanded outside of the yellow plate, just trim the excess felt and periodically inspect the plate and frame for wear.

### Replacing the Felt Strips

It is recommended to replace all 4 felt strips at the same time to keep the plate even.



1. Loosen or remove the white strips securing the yellow plate.
2. Pull the yellow plate away from the wall and scrape off the old glue.
3. Remove the adhesive backing from the new felt strip and apply it in the same locations.

**Figure 2-10: Location of the Felt Strips**

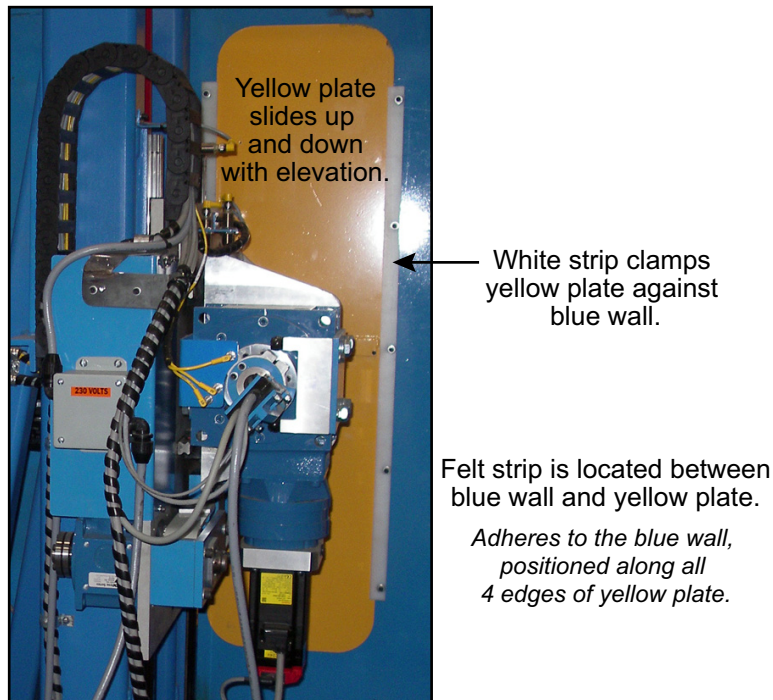

## Elevation Pins

Elevation pins are used to hold the elevation in place and square. They provide the ability to remove the elevation, although normal use of the saw should not require this.

**Figure2-11:  
Elevation  
Pin**

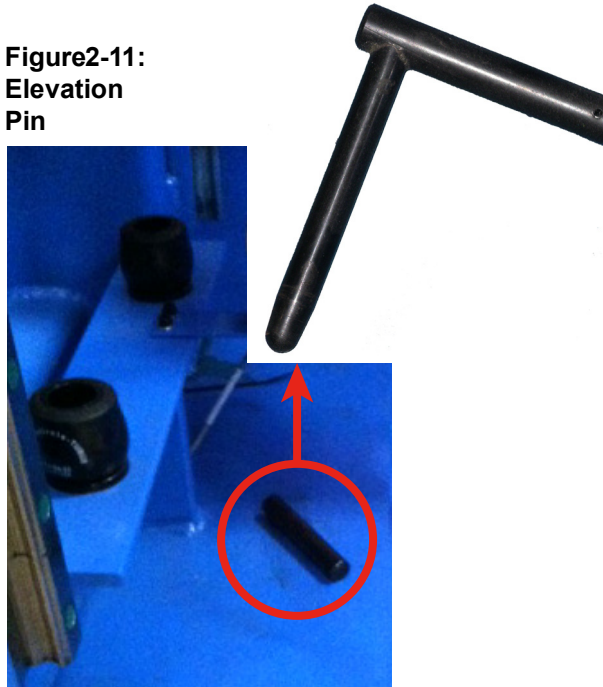

## Bumpers

PN

Not all bumpers are the same size. Refer to the Parts List appendix or Parts Finder online for the correct part number.

Rubber bumpers are used on the following axes to reduce stress on mechanical parts when stopping at the end of their range:

- LASM
- Stroke
- Elevation
- Gripper

To replace a bumper, remove the screw in the middle and discard of the damaged bumper.



**Figure 2-12: Bumpers on LASM Travel**

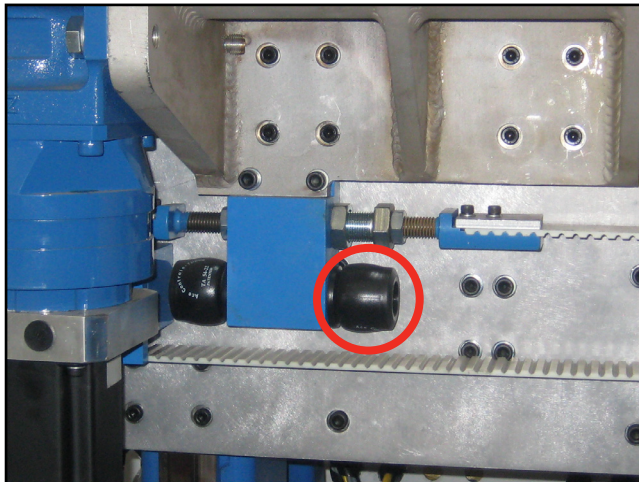



## Brushes

**Figure 2-13: Brush on LASM Rail**

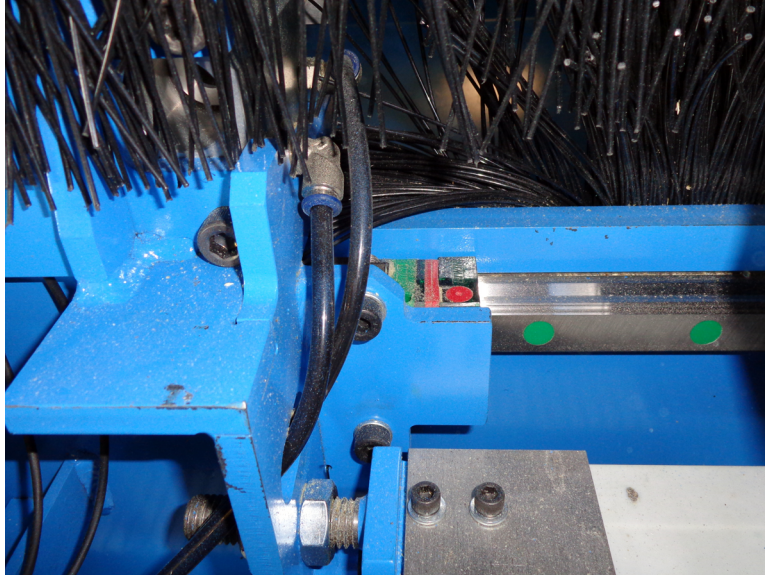

Brushes exist at some openings and rails to keep scrap and other debris from accidentally entering the saw chamber or sitting on a rail causing an axis obstruction. The brushes should be inspected periodically and replaced when necessary.

As of June 2015, the LASM brushes are designed to be installed as shown in Figure 2-14. For previous designs, this design is a direct replacement for the previous version.

**Figure 2-14: Installing LASM Brushes**

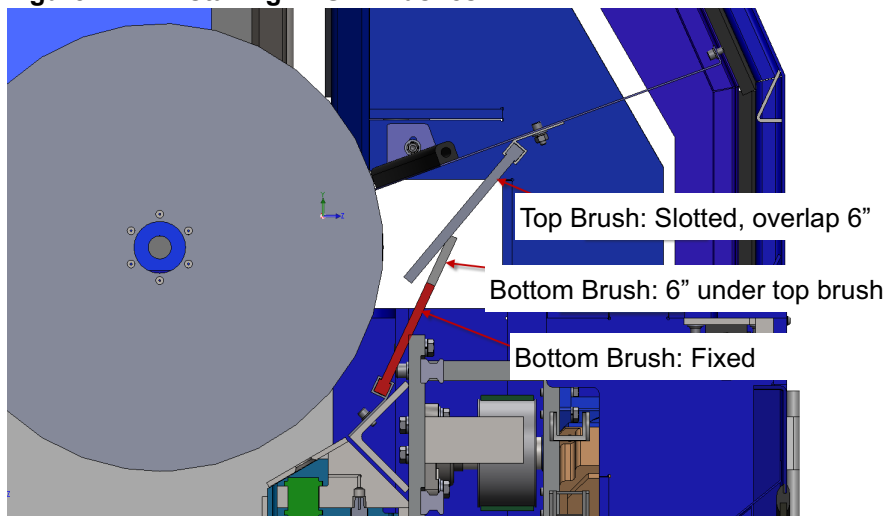

## Shock Absorbers

The following shock absorbers keep the clamps from slamming at the end of their cycle.

- Top clamp: Located on extend and retract positions.
- Infeed side clamp: Located on retract position only.
- Outfeed side clamp: Located on retract position only and controls clamp opening.

## Replacing a Shock Absorber

1. Preparing the Saw:
  - a) Move the component requiring the shock absorber to make accessible:
    - For the infeed side clamp, move the gripper to Home position.
    - No positioning is required when replacing the infeed side clamp or outfeed clamp shock absorber.
  - b) Lock out and tag out the source that supplies power to the saw.
2. Unscrew the locknut and damaged shock absorber and discard all pieces.
3. Install the new shock absorber into the bracket:
  - a) Remove the lock nut from the new shock absorber.
  - b) Place the collapsible end through the bracket pointing the correct direction, and screw it in as indicated in Table 2-9.
  - c) Slide the lock nut over the collapsible end and tighten against the bracket.
4. Check that the sensors on the cylinder that control “fully open” and “fully closed” are set correctly. Their location may need to be slightly adjusted.

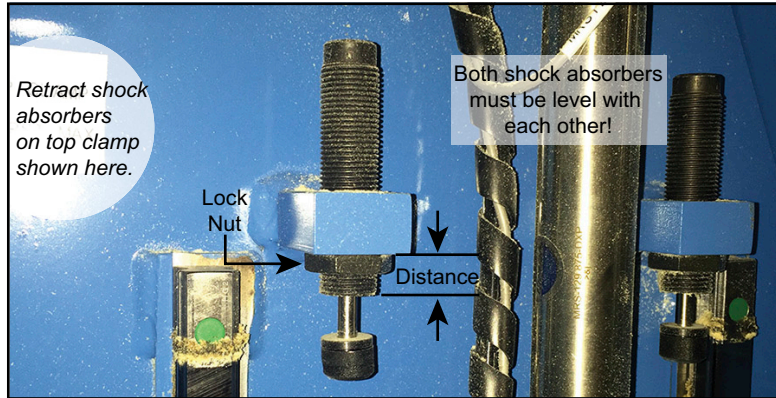

**Table 2-9: Shock Absorber Installation Properties**

| Location                   | Qty | PN & Graphic          | Distance   | Piston points... |
|----------------------------|-----|-----------------------|--|------------------|
| Top Clamp: Top (retract)   | 2   | 447010<br>Figure 2-15 | 1/2" from bottom surface of bracket to end of shock absorber body.       | Down             |
| Top Clamp: Bottom (extend) | 2   | 447010<br>Figure 2-15 | 1/2" from top surface of bracket to end of shock absorber body.          | Up               |
| Infeed Side Clamp          | 1   | 447009<br>Figure 2-16 | See Figure 2-16.   | Toward saw front |
| Outfeed Clamp              | 1   | 447009<br>Figure 2-17 | Adjust to 2-1/2" between lumber exit chain teeth and camfollower.<br>See | Toward saw front |

## Adjusting a Shock Absorber

**Figure 2-15: Shock Absorbers for Top Clamp Retract Stroke (see Table 2-9)**



**Figure 2-16: Top View of Infeed Side Clamp Rollers**

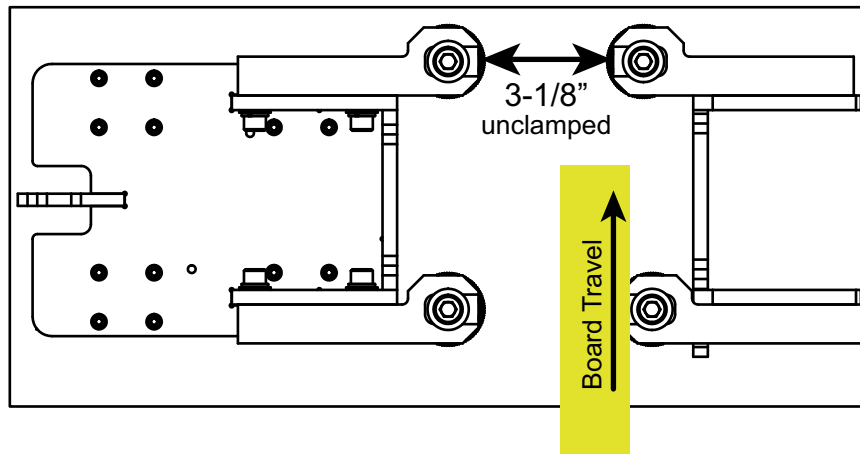

**Figure 2-17: Adjusting a Shock Absorber (shown on outfeed clamp)**

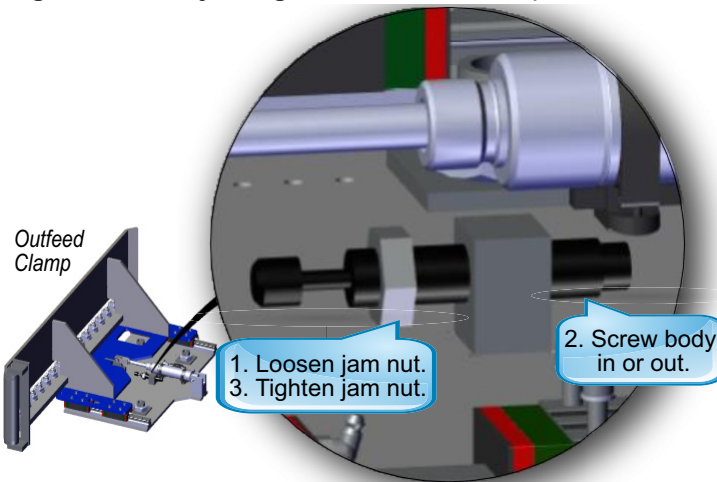



## SECTION 2: MECHANICAL ASSEMBLIES

### Auto Deck Staging Conveyor



The Auto Deck will not operate from the Auto Deck control station in the forward direction unless the Infeed Rail's load arms are up. In the *BLADE* software, click the *Load Arms* indicator on the Home Screen and choose *Up* to manually raise them.

#### Auto Deck Sequence of Events

To assist in troubleshooting and analyzing the health of your Auto Deck system, here is a brief summary of how the system works.

1. An operator places lumber onto the end of the Auto Deck chains, against the angle fence.
2. The Auto Deck lumber pusher, on the Infeed Rail-end of Auto Deck, works with a sensor. When the Board Sensor detects a board, the lumber pusher pushes it away from the fence.
3. The conveyor chain advances and the board travels to the load arms which are up. The board is squared by the load arms, then the load arms go down, and the conveyor chain advances until the Load Arms Sensor detects the board and stops the conveyor chain.
4. The load arms then flip the board onto the Infeed Rail, and the process starts over.

**Figure 2-18: Lumber Pusher and Sensor**

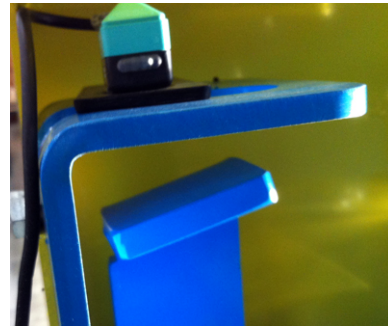

**Figure 2-19: Load Arms in Orange**



## Understanding the Lumber Stops

The lumber stops separate different jobs that may be on the Auto Deck staging conveyor at the same time. They can also provide spacing between groups of boards to reduce the amount of pressure placed on the board by the other boards on the Auto Deck. Excessive pressure can cause boards to become skewed and load improperly onto the Infeed Rail.

The lumber stops are pneumatically activated up or down by turning the selector switch shown in Figure 2-20. The operation of the Auto Deck is described on page OP-155 in the Operation Manual.

**Figure 2-20: Auto Deck Control Station for Manual Controls**

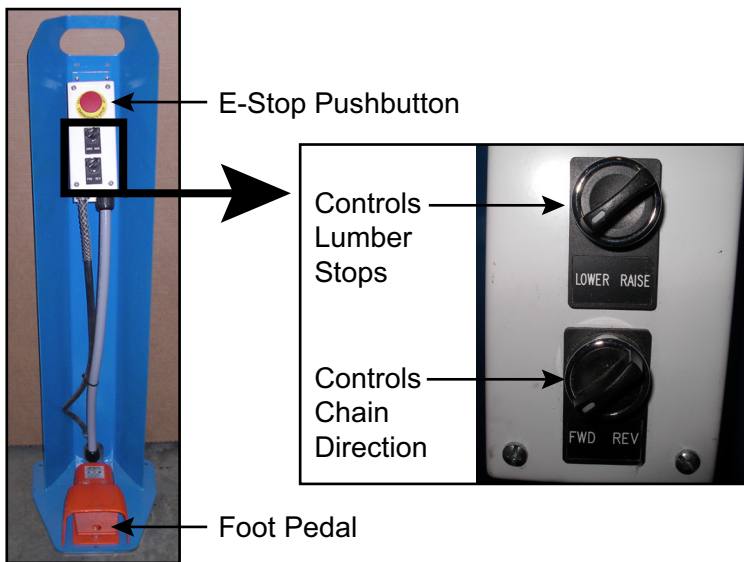

## Operating the Lumber Stop Cylinders

There is no adjustment for the lumber stop cylinders. Pneumatic air causes them to raise or lower when the selector switch shown in Figure 2-20 is turned to LOWER.

### Lumber Stops Pneumatic Cylinder

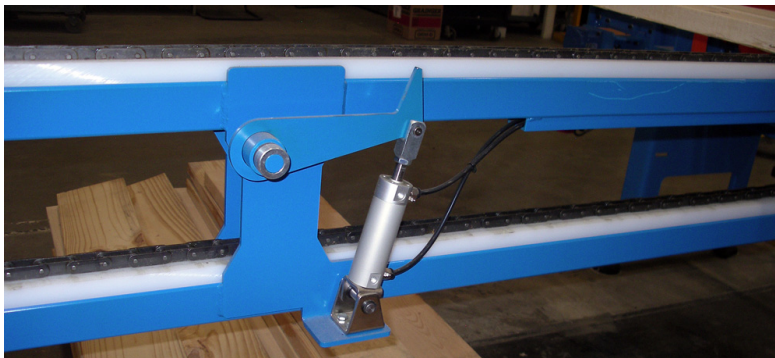

## Lubricating the Auto Deck Shaft



Apply #2 lithium-based grease to the grease fittings on the Auto Deck shaft bearings once a year. There is 1 fitting for each Auto Deck strand, so a standard-length system has 4.

**Figure 2-21: Grease Fitting for Auto Deck Shaft**



## Tensioning the Auto Deck Chain



To tension the chain, loosen the locknut shown in the middle of the take-up in Figure 2-22. Manually pry the take-up, one notch at a time, until the chain is the desired tension, then re-tighten the locknut.

**Figure 2-22: Tension Take-Up**

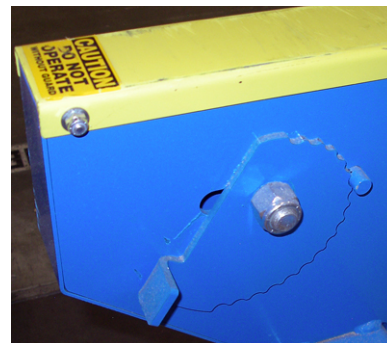

Do not over-tension the Auto Deck chain.  
An excessive load will cause the VFD to show a fault.



## Infeed Rail & Gripper

### Overview of Gripper

The gripper is the assembly that moves the lumber along the Infeed Rail.

**Figure 2-23: Gripper**

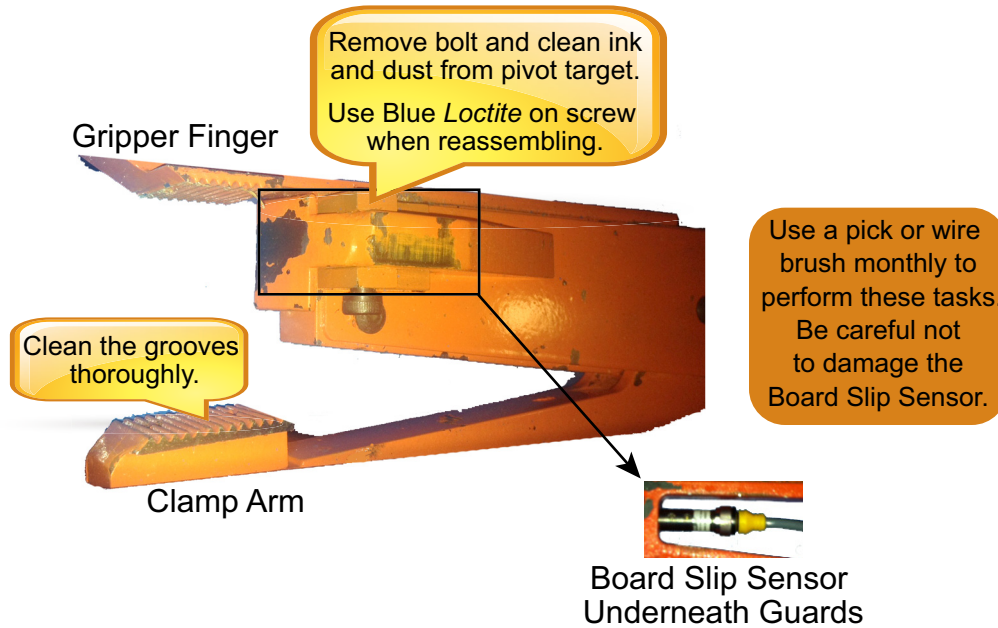

**Figure 2-24: Board Seated Properly in Gripper**



Board entering gripper clamp.



Board aligned and clamped.

## Gripper Clamping Finger Maintenance

If the gripper clamping finger becomes sluggish when opening and closing, clean as directed in Figure 2-23. If it remains sluggish, disassemble it to clean and lubricate the individual parts.

**Figure 2-25: Adjust the Jam Nut if Finger is Loose**

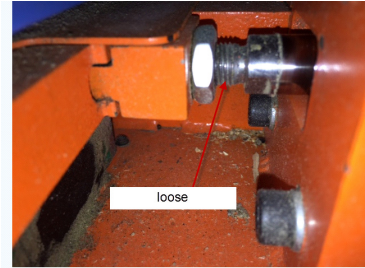

## Adjusting the Gripper Belt

See page MT-85 for gripper timing belt adjustments.

## Adjusting the Load Arms

### Adjusting the Load Arm Positions

The load arms must be level with each other and at the correct angle to drop the board on the Infeed Rail belt. They should be slightly below the height of the Auto Deck chain when in a flat (down) position as shown in Figure 2-19.

### Adjusting the Load Arm Speed

The speed at which the load arms rotate can be adjusted using the flow control valve on the pneumatic cylinder. This should not be necessary in most circumstances, but if you feel the arms are slamming too hard at the end of their cycle, slightly adjust the flow control valve located on each of the cylinder ports.



**Figure 2-26: Load Arms Shown in Orange (in Horizontal Position)**



## Infeed Top Clamp and Side Clamp

The top clamp and side clamp are on the infeed side of the saw, just before lumber enters the saw chamber. They ensure that the board is in proper position for the LASM to grab it.

Both clamps operate with pneumatic power. Sensors tell the PLC when the clamps are retracted or extended.

**Figure 2-27: Clamps Used on Infeed Side of Saw**

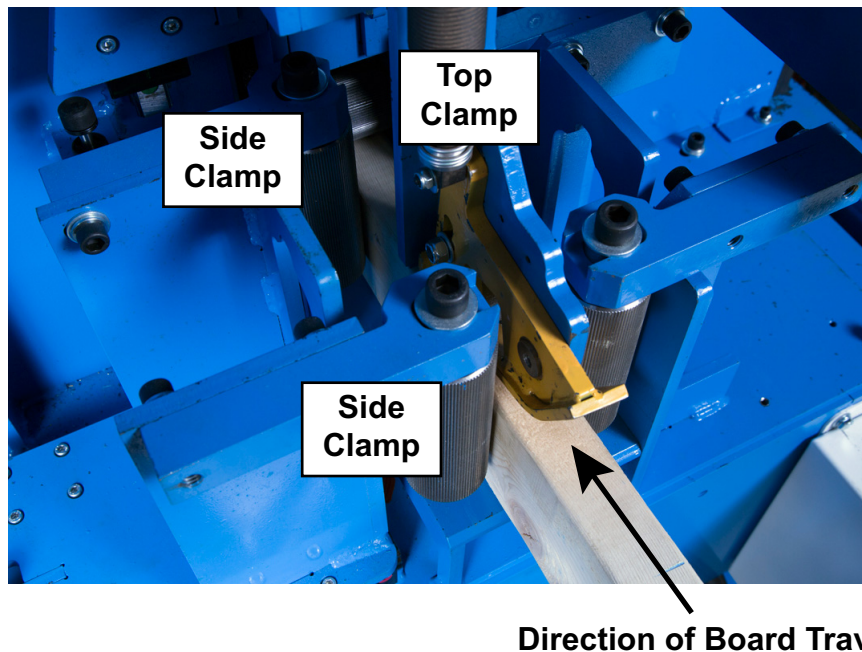

## Raising the Clamp & Printer Assembly

For ease of maintenance, the assembly containing the infeed clamp, top clamp, and printer can be raised and locked into place when the saw is not operating. To raise and lock the assembly:

1. From the saw's operator interface (menu for *Clamp* indicator), unclamp the top clamp.
2. Open the saw chamber door.
3. Engage the lever inside the saw chamber, on the left (infeed) side. It is shown in Figure 2-28.

**Figure 2-28: Raising the Infeed Clamp & Printer Assembly**





## **Lubricating the Linear Guide Bearings**

Refer to page MT-89 for lubrication instructions.

## **Shock Absorbers**

Refer to page MT-103 for replacement and adjustment instructions.

## Adjusting Clamp Speed



### Side and Outfeed Clamps

The infeed side clamp and the outfeed clamp have a flow control valve on the cylinder to adjust the speed of the retract stroke.

### Top Clamp



The top clamp, located on the infeed side of the saw, has a speed muffer to dump the air pressure. The screw at the bottom of the muffer can be adjusted to control how quickly the air is dumped. Move the screw out to increase the speed of the retract stroke or move it in to decrease the speed.

The clamp's extend stroke uses all of the pressure passing through the clamp's air regulator. There is no additional adjustment.

**Figure 2-29: Speed Muffer for Top Clamp**

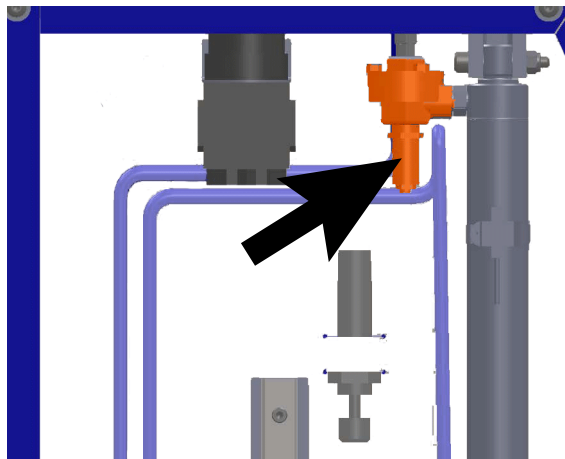



## LASM

### LASM Belt and Bearings

The LASM timing belt is discussed on page MT-88.

The LASM linear guide bearings are discussed on page MT-91.

Measure the fixed jaw of LASM periodically to ensure it is not worn. It must be at least 1-1/2" thick. If worn to less than that, replace it as soon as possible.

**Figure 2-30: LASM**



### Replacing the LASM Spikes

Spikes (socket-head cap screws) are assembled into the carriage side of the LASM jaw to hold the board in place. When spikes become dull or damaged, unscrew each spike and replace each with a new spike, ensuring the spike extends 1/8" past the LASM jaw surface. Use red thread adhesive.

**Figure 2-31: Replacing a LASM Spike**

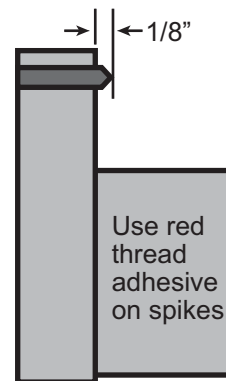

## Outfeed Assembly

The outfeed assembly consists of the following:

- A pneumatically powered *outfeed clamp* with camfollowers at the bottom edge
- A *lumber exit chain*



Refer to Figure 2-35 for outfeed assembly adjustments.

If the board is long enough, the outfeed clamp holds the end of the board during the cut. It then opens while the LASM moves the finished part farther into the outfeed chamber. Then, the outfeed clamp closes again to push it against the lumber exit chain, and the lumber exit chain pulls the finished part out of the saw chamber and pushes it onto the outfeed table or conveyor.

**Figure 2-32: Outfeed Assembly Overview**

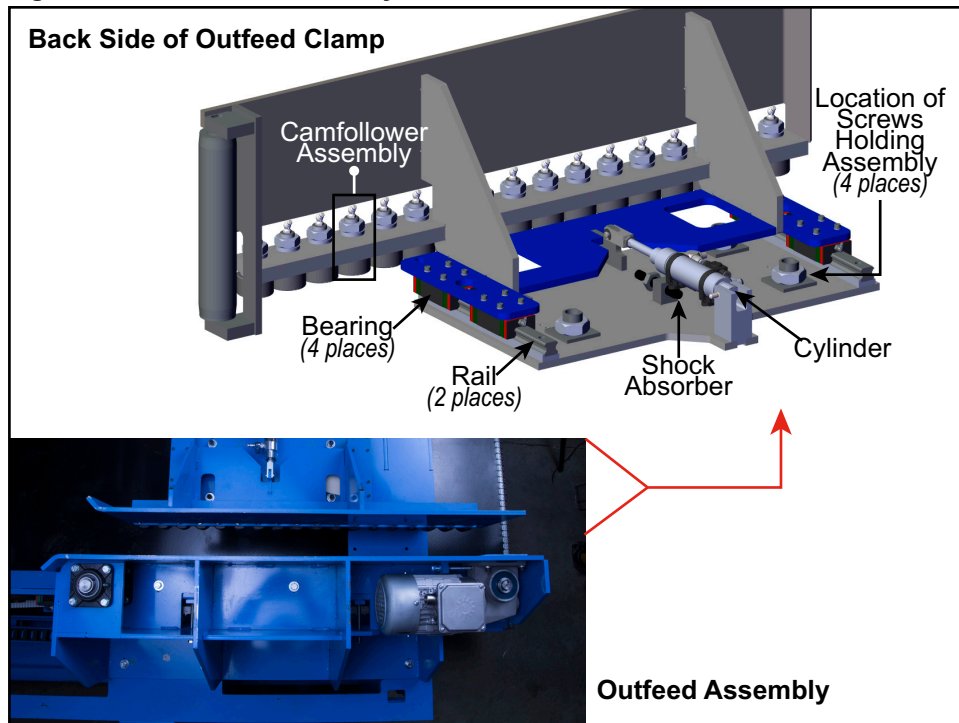

**Table 2-10: Outfeed Components Alignment Guide**

| This....                   | Must Be               | This...             |
|----------------------------|-----------------------|---------------------|
| lumber exit chain          | parallel to           | LASM fixed jaw rail |
| lumber exit chain          | in straight line with | sprockets           |
| outfeed clamp camfollowers | parallel to           | lumber exit chain   |

## Lubricating the Outfeed Clamp Camfollowers



As a board exits the saw chamber, a set of camfollowers make contact with the board's back surface to guide it and ease its travel to the outfeed table or conveyor. Apply a #2 lithium-based grease to each of these camfollowers once every year. Remove the top guard to access the camfollowers.

**Figure 2-33: Lubricating the Outfeed Clamp Camfollowers**

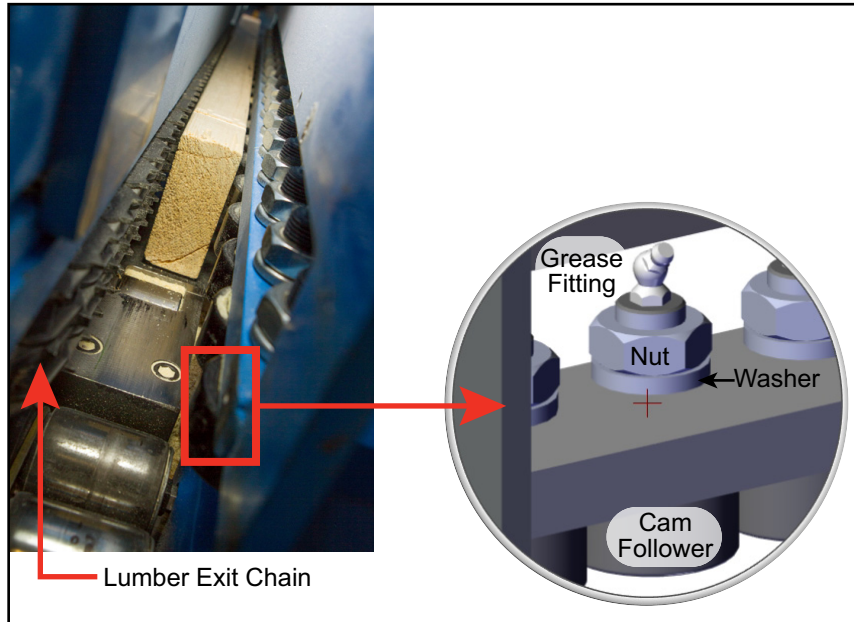

## Replacing Outfeed Clamp Camfollowers

1. Remove all of the cam follower assemblies from the old outfeed clamp assembly so they can be reused:
  - a) Loosen and remove the nut shown in Figure 2-33.
  - b) Catch the cam follower (with grease fitting attached) as it falls out when the nut is removed. Repeat for all cam followers.
2. Install cam followers into the new outfeed clamp assembly:
  - a) Using the same hardware, place a washer over a cam follower shaft.
  - b) Place the cam follower shaft through a hole in the new outfeed clamp assembly, place a lock washer over the top of the shaft and screw on the nut. Tighten the nut with a hex socket. The shaft has a flat surface to prevent it from spinning while tightening the nut. Repeat for all camfollowers.



## Lubricating the Lumber Exit Chain Drive Motor & Bearings

The lumber exit chain drive motor and idle-end bearings require #2 lithium-based grease once a year.

Figure 2-34: Lubricate the Lumber Exit Chain Assembly Bearings

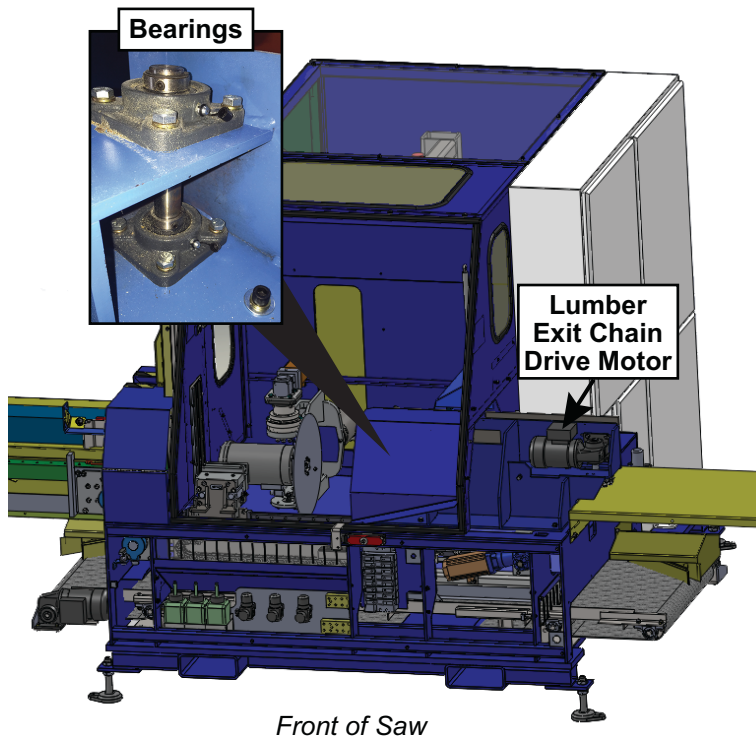

## Maintaining the Lumber Exit Chain



The lumber exit chain does not require lubrication. Occasionally blow off the area around the chain and outfeed assembly to reduce debris and the risk of jams.



## Adjusting the Lumber Exit Chain Tension

1. Loosen 4 bolts labeled **B** in Figure 2-35, on the back side of the motor plate.
2. Loosen the jam nut and adjust tension bolt labeled **C** to slightly move the motor.
3. Tighten the jam nut and bolts **B**.

**Figure 2-35: Adjustments on Chain Side of Outfeed Assembly, Top View**

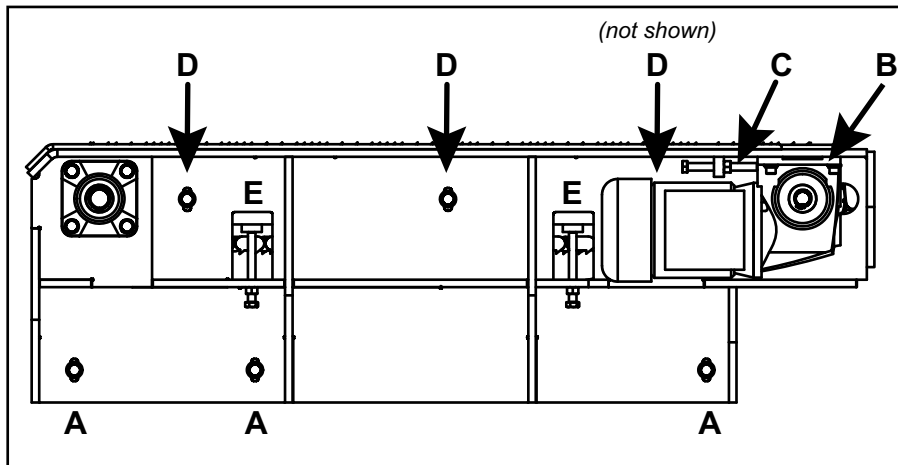

## Adjusting the Lumber Exit Chain Location



The lumber exit chain must be perfectly parallel with the LASM jaws. All other alignments are measured off of the lumber exit chain, so it must be straight and in a location as described here. To adjust the location of the entire lumber exit chain assembly:

- a) Ensure the lumber exit chain is parallel with the travel rail for LASM fixed jaw and the chain teeth protrude 1/16" in front of the rail.

Check this measurement with LASM at left end of the lumber exit chain, and again with the LASM all the way to the right. Both ends must be identical indicating the lumber exit chain and LASM rail are parallel.

- b) Ensure the channel for the lumber is approximately 2-1/2" wide from tip of chain teeth to surface of cam followers when fully unclamped.
- c) If it is necessary to adjust the lumber exit chain, follow these steps:
  - 1) Loosen the 3 bolts labeled **A** in Figure 2-35.
  - 2) Push or pull on the lumber exit chain assembly to align as described previously.
  - 3) Tighten the 3 bolts labeled **A** in Figure 2-35.



Refer to  
Figure 2-35

## Adjusting the Chain Guide Bracket

The chain guide bracket shown in yellow in Figure 2-36 holds the lumber exit chain so that it does not sag and stays in line with the sprockets. To adjust the location of the chain guide bracket, follow these steps using the following graphics as reference.

**Figure 2-36: Bottom View of Chain, Lumber Exit Chain Guide Highlighted**

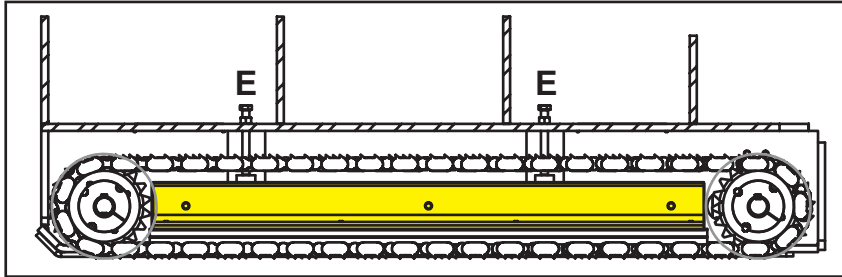

**Figure 2-37: Outfeed Assembly Adjustments, Top View**

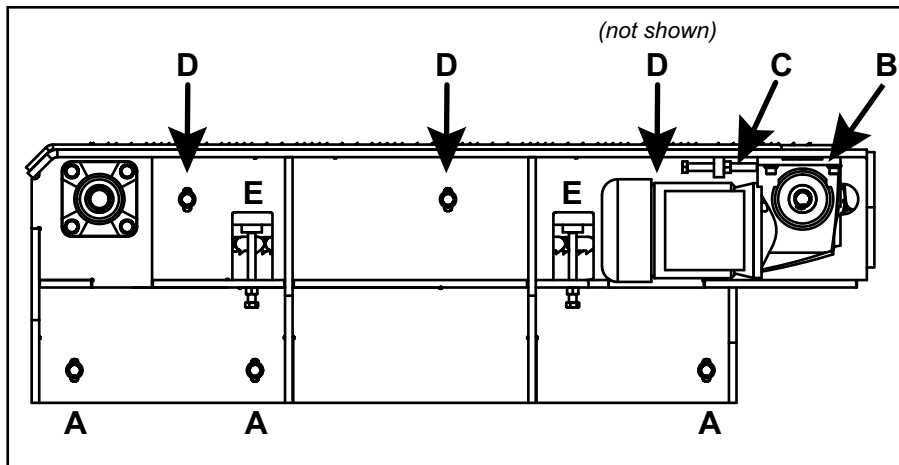

1. Loosen the 3 bolts labeled **D** in Figure 2-37.
2. Using the 2 jack screws labeled **E** in Figure 2-36 and Figure 2-37, loosen the jam nuts and adjust the jack screws to slightly move each end of the chain in or out. The chain must be in this position:
  - Lumber exit chain must be tangent with the sprockets.
  - If the lumber exit chain is a straight line between the sprockets, it will also be parallel to the LASM fixed jaw as described on page MT-117.
  - There must not be any sag or wave in the lumber exit chain.
3. Tighten the jam nuts on bolts **E** and tighten bolts **D**.

## Adjusting the Outfeed Clamp

The outfeed clamp camfollowers must be parallel to the lumber exit chain at all times.



1. Mechanically adjust the clamp location using these steps. Steps for adjusting in smaller increments occur in the next step.
  - a) Set the lumber exit chain location EXACTLY as described on page MT-117.



The lumber exit chain MUST be parallel and 1/16" forward of LASM as described on page MT-117.

2. Use these steps to align the outfeed clamp assembly and sensors to accomplish these bullet points:

- Outfeed clamp assembly is parallel to the lumber exit chain.
- More than 2-1/2" gap between tip of chain teeth and edge of cam followers (with clamp fully retracted). This measurement will be refined with sensor location and shock absorber later.
- 1-3/8" or less gap when fully extended without board in it.
- Should have slight offset between front edge of outfeed clamp cam followers and front edge of powered skewed conveyor cam followers. This can be adjusted on the powered skewed conveyor.

- a) To make adjustments, loosen the bolts circled in Figure 2-39 and adjust the entire clamp assembly so it is parallel with the lumber exit chain.

**Figure 2-38: Screws**

**Requiring Attention**

**Figure 2-38: Bolts Holding Outfeed Clamp Assembly**

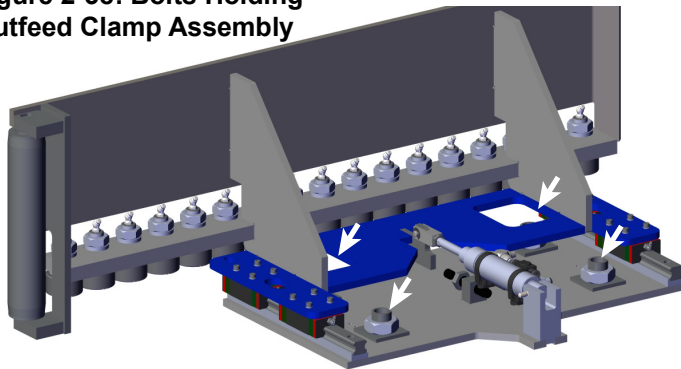



- b) Adjust the outfeed clamp sensors so the clamp opens and clamps to the proper dimensions given previously.

**Figure 2-39: Outfeed Clamp Adjustment**

Outfeed Clamped Sensor →      ← Outfeed Unclamped Sensor



- c) To adjust the outfeed clamp in small increments to reach the correct lumber channel, adjust the shock absorber as described in Figure 2-17 on page MT-104.



## Removing the Existing Outfeed Clamp Assembly

If there is ever a need to remove or replace the entire outfeed clamp assembly, familiarize yourself with Figure 2-32 to assist in following these steps.

1. Verify the LASM is all the way toward the infeed side of the saw chamber and the electrical power is locked and tagged out.
2. Remove the outfeed clamp assembly by following these steps:
  - a) Remove the guards shown in Figure 2-40 with a hex key.

**Figure 2-40: Remove These Guards**

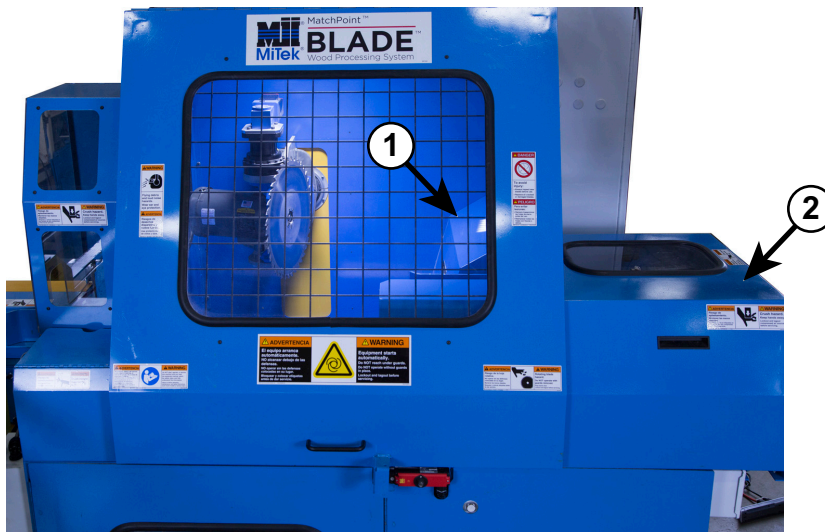

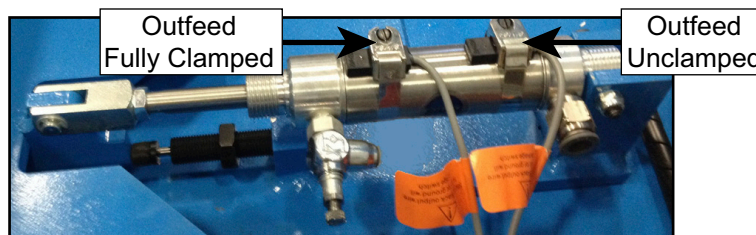

- b) Remove the 2 sensors shown in Figure 2-41 from the outfeed clamp cylinder as described:
  - 1) Mark each sensor to identify it as “outfeed fully clamped” and “outfeed unclamped”.
  - 2) Document how the wires are attached to the sensor so it can be re-attached in the same way.
  - 3) Inspect the wires and connection to the sensors.

**Figure 2-41: Label and Remove These Sensors From the Cylinder**



- c) Blow off the entire area to facilitate the rest of this procedure.
- d) Remove the 4 socket-head cap screws shown in Figure 2-42 with a hex key and remove the lock washers. These can be discarded.

|  |   |
|--|---|
|  <b>CAUTION</b> |   |
|                 | <p><b>2-man lift required to safely lift the outfeed assembly!</b><br/>It may weight as much as 120 lb.</p> |

- e) Lift off the entire outfeed clamp assembly.

**Figure 2-42: Screws Requiring Attention**

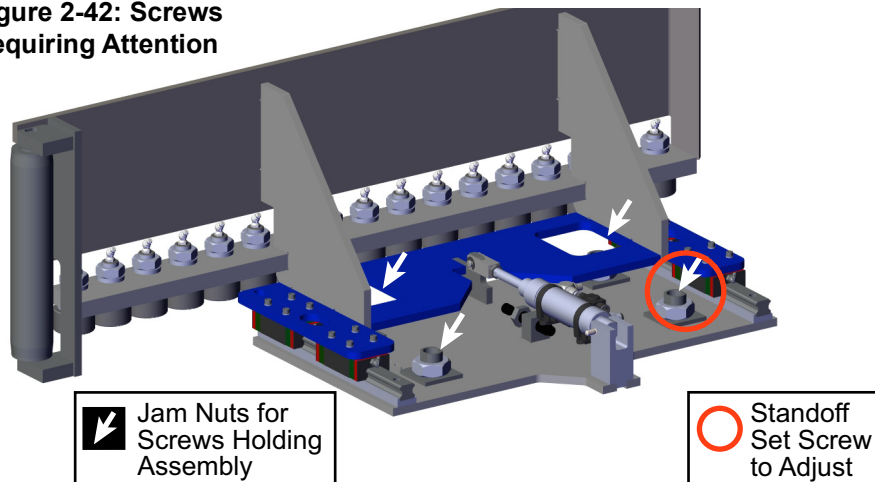

## Installing the Existing Outfeed Clamp Assembly (2016)



If the frame does not have alignment holes, SB220KIT that was sent to all existing saws in 2016 has not been installed correctly. Locate and install SB220KIT. SB220 instructions can be found on the MiTek web site.

1. Measure the fixed jaw of LASM to ensure it is at least 1-1/2" thick. If worn to less than that, replace it before making final adjustments to the Outfeed Clamp.
2. Align the lumber exit chain EXACTLY as described on page MT-117.
3. Attach the new outfeed clamp assembly to the saw by following these steps:
  - a) Set the outfeed clamp assembly in place, making sure not to damage the wires, sensors, or air lines.
  - b) Place the four (4) 3/8-16x1-3/4" screws and lock washers provided at the locations show with arrows in Figure 2-42.
  - c) 3 of the 4 Stand-Off Set Screws are preset. Adjust the 1 Stand-Off Set Screw indicated in Figure 2-42 until it bottoms out on the base face and stop. Do **not** adjust the other 3 Stand-Off Set Screws.
  - d) Lock the jam nut in for the Stand-Off Set Screw circled in Figure 2-42.

4. Align the outfeed clamp assembly EXACTLY as described on page MT-119.
5. Make adjustments in small increments by adjusting the shock absorber as shown on page MT-104
6. Place a board in the LASM and outfeed clamp, then manually clamp both. Ensure the board is securely clamped, verify all rollers and cam followers engage, and everything is aligned.
7. Once everything is aligned, pin the assembly to keep it from slipping.
  - a) Pick any of the three existing outfeed clamp alignment holes shown in Figure 2-43 and drill a through-hole through the frame directly behind the existing alignment hole. Use a 3/16" drill bit.
  - b) Repeat at the alignment holes on the other end of the outfeed clamp.
  - c) Place a pin in the newly drilled hole on each end to keep the outfeed clamp assembly from slipping on the saw frame.

**Figure 2-43: Place Pin in Alignment Hole**

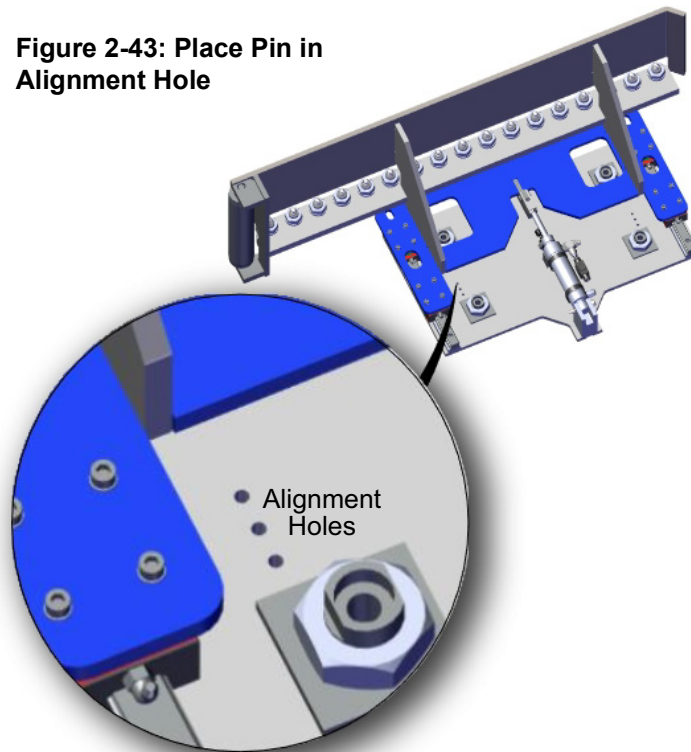

8. If your system has the optional Powered Skewed Conveyor, it is important that it aligns perfectly with the outfeed assembly on the saw EXACTLY as described on page MT-130.
9. Install the sensors. They are shown in Figure 2-41. Refer to the electrical drawing located in your Equipment Manual if necessary.

## Waste Conveyor

### Lubricating the Drive Shaft



Lubricate the waste conveyor bearings with #2 Lithium-based grease once a year. There is 1 grease fitting on each end of the drive shaft.

**Figure 2-44: Waste Conveyor Grease Fitting**

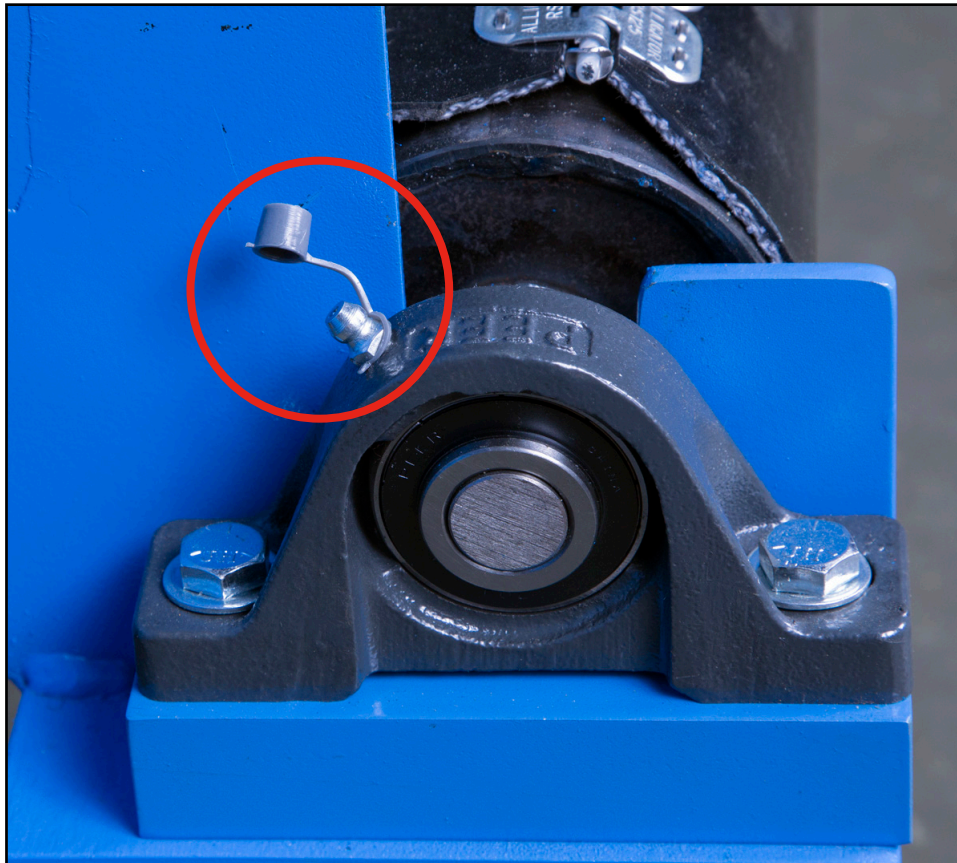

## Adjusting the Belt Tension

Tighten the roller on the idle end. Start with the take-up bolt at approximately 2-1/2". Adjust as needed so the belt runs smoothly.

**Figure 2-45: Adjust the Take-Up Bolt on Non-Drive End**

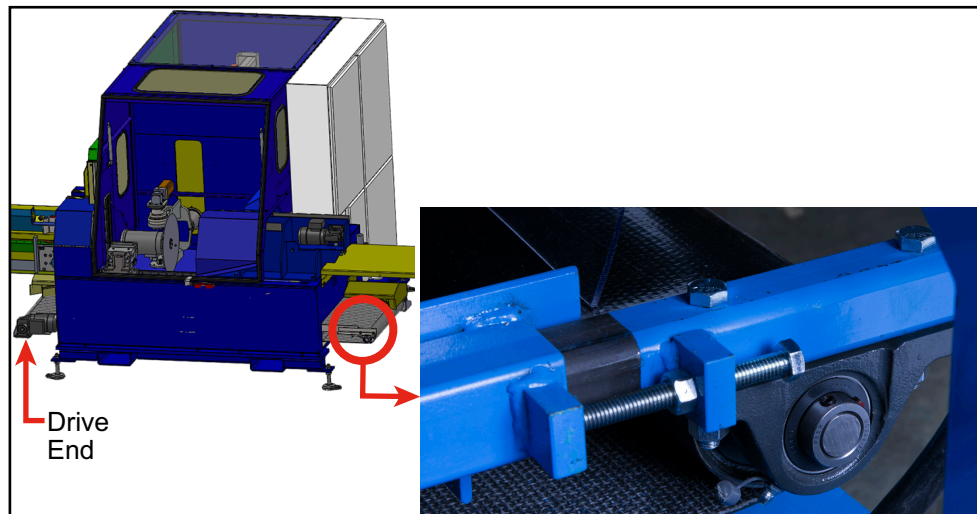

## Adjusting the Belt Tracking

The belt will not track perfectly the first time. Some minor adjustments are needed at this point. The key to perfect tracking is to make each adjustment very small and to remain patient as it may require more than one roller to be adjusted. Expect several adjustment cycles before the belt tracks perfectly.

|   |  |
|---|--|
|   |  <b>CAUTION</b>   |
|  | <b>Use your company's approved lockout/tagout guidelines while adjusting the belt. Ensure that nobody can turn on the conveyor without notifying all personnel in the restricted zone.</b> |

1. After tensioning the belt, test the tracking:
  - a) Remove lockout/tagout devices and power up the saw.
  - b) Run the conveyor and watch how the belt tracks.
2. If the belt walks toward one side, adjust it as described here.
  - a) Determine which way the belt needs to move toward, and address THAT end.
  - b) Refer to the correct graphic on page MT-127 to locate the tracking roller.
  - c) Adjust the angle of the tracking roller so THAT end angle back, away from the drive end.

### **YOU ARE DONE WHEN:**

The belt should stay approximately centered on the conveyor bed. Some minor back and forth motion is normal, but it should never rub the side of the conveyor bed frame.



Figure 2-46: Tracking and Tensioning Waste Conveyors Made 2016 or Later

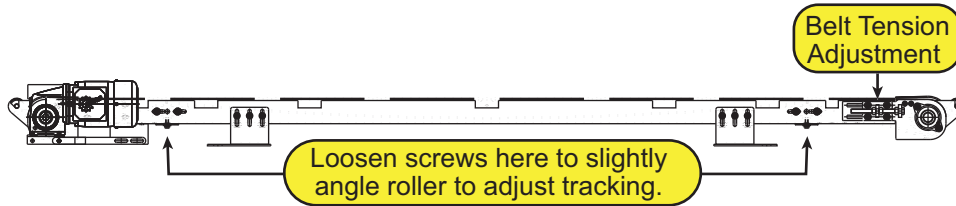
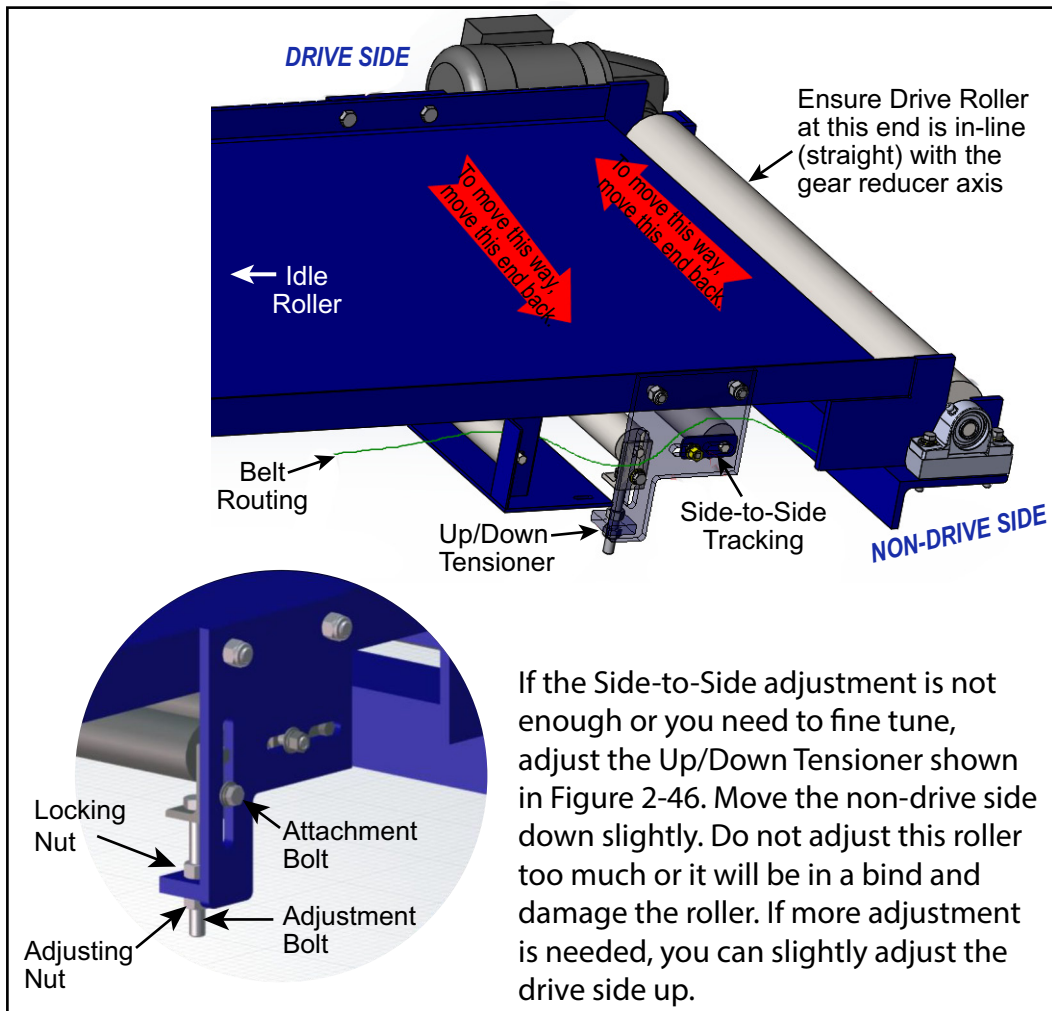

Figure 2-47: Tracking and Tensioning for Waste Conveyors Made Through 2015



## Replacing a Waste Conveyor Belt

The waste conveyor belt should be replaced about every 3 years, depending on use and maintenance. Use the following steps as a guide for replacing the main or optional belt.

1. Run the waste conveyor until the lacing connection is near the head roller at the drive end.
  - a) In the *BLADE* software, go to *Diagnostics>Detailed Diagnostics>Machine* tab
  - b) Turn the waste conveyor on and off with the button by *Waste Conveyor*.
2. Turn off all power to the saw, following approved lockout/tagout procedures.
3. Remove the old belt by following these steps:
  - a) Relieve the tension on the belt using the tensioning bolts. See page MT-125.
  - b) Remove the end washers (if present), then remove the wire that is threaded through the lacing. Save the wire for reassembly.
  - c) Remove the old belt.
4. Clean the sawdust and chips from the entire length of the metal conveyor bed.
5. Install a new belt by following these steps:
  - a) Thread the belt as shown in Figure 2-48, keeping the lacing connection near the head roller.



To pull the new belt through the machine more easily, thread the new belt to the old one and pull it through the machine. This will help thread the belt into the rollers on the bottom.

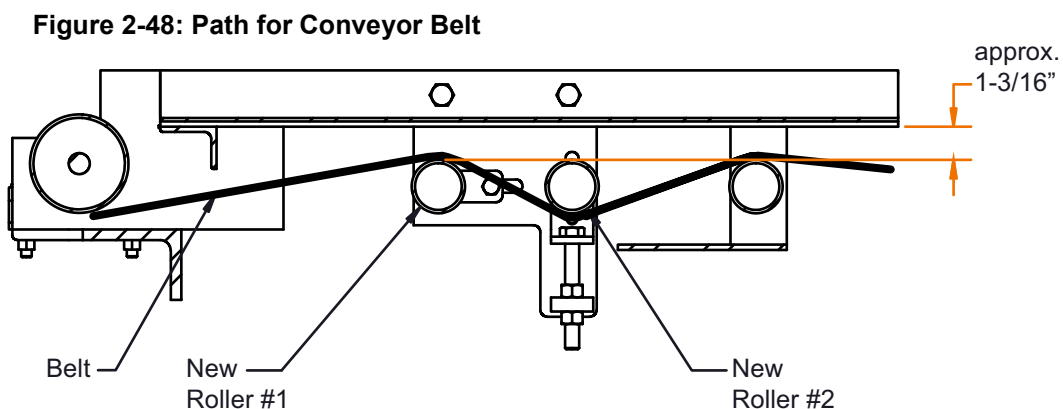



- b) Bring the belt together so the lacing intermeshes, and slide the rod or wire through the lacing as shown in Figure 2-49.

**Figure 2-49: Connecting Wire on Belt**

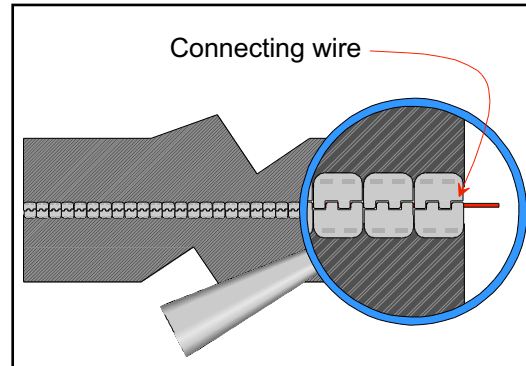

**Figure 2-50: Two Different Connecting Wire Styles**

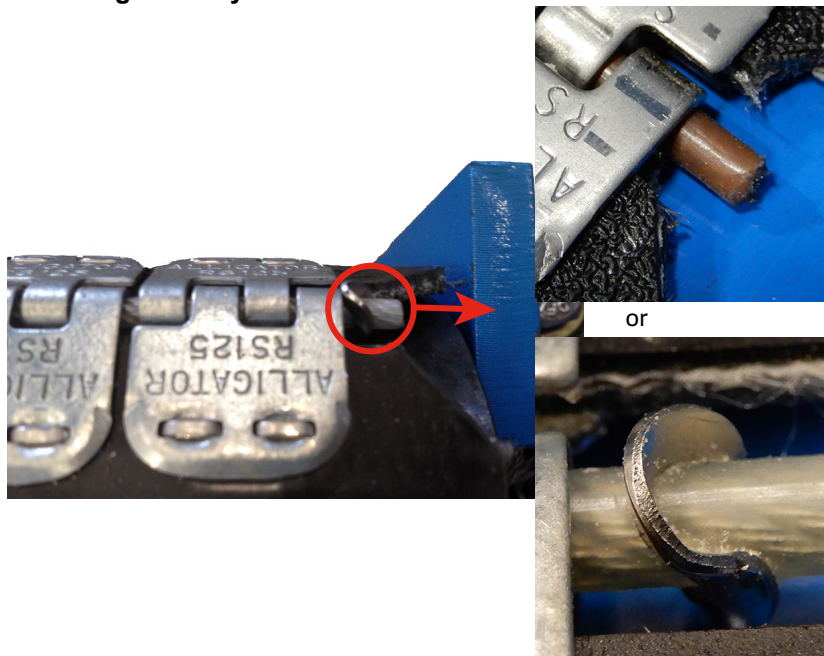

6. Adjust the belt tension evenly at the head roller adjusting bolts. See Figure 2-45 on page MT-125.
7. Run the conveyor for at least five (5) minutes and check the belt tracking. If the belt does not track correctly, follow the instructions on page MT-126.

## Powered Skewed Conveyor (optional equipment)

The Powered Skewed Conveyor is an option that replaces the outfeed table. It is a powered conveyor that drives the lumber away from the saw's outfeed chamber to be offloaded or directed onto other conveyors. A separate VFD controls the Powered Skewed Conveyor, but no adjustments or maintenance should be needed on this VFD.

### Aligning/Adjusting the Powered Skewed Conveyor

- The side skatewheel fence and adjustable side skatewheel assembly must be parallel with each other. The gap should allow the exiting lumber to travel freely without rubbing hard on either side.
- 8. If your system has the optional Powered Skewed Conveyor, it is important that it aligns perfectly with the outfeed assembly on the saw.
  - a) Check the alignment of the Powered Skewed Conveyor's side guide:
    - It should measure 2-17/32" skatewheel to skatewheel.
    - The skatewheels on the front side of the Powered Skewed Conveyor (closest to the operator) should be even with and in-line with the tips of the outfeed chain.
    - The skatewheels on the back side of the Powered Skewed Conveyor (the side farthest away from operator) must be slightly farther back than the outfeed clamp rollers when retracted.
    - Skewed conveyor rollers should be slightly lower than exit ramp roller on the saw.
  - b) If needed, adjust the Powered Skewed Conveyor side guide location:
    - The short side of the Powered Skewed Conveyor fence is adjustable. The long side is fixed.
    - Depending on which option you have, adjust the short side to the right depth and/or move the entire Powered Skewed Conveyor using the slots in the feet.

### Lubricating the Powered Skewed Conveyor



#### Lubricating Wheels

There are 2 drive wheels that drive the belts. Each of the drive wheels have 2 bearings with grease fittings on them. Use a #2 lithium-based grease every 6 months. The non-powered wheels that guide the belt require no lubrication. The conveyor rollers and skatewheels on the Powered Skewed Conveyor require no lubrication.



## Lubricating Motor & Gearbox

Grease is required once a year for the Powered Skewed Conveyor motor, located in the center of the conveyor. Use #2 lithium-based grease.

The gearbox is sealed and requires no oil or oil changes. Do not remove the vent plug.

**Figure 2-51: Powered Skewed Conveyor Maintenance**



## Adjusting Belt Tension on Powered Skewed Conveyor

The Powered Skewed Conveyor belt is driven by 2 drive wheels, both powered by the same motor. The belt should be tensioned so it moves easily and smoothly without much slack. To adjust the tension, refer to Figure 2-52 and these steps:

1. Loosen the 2 bolts holding the bearing on the frame.
2. Adjust the drive wheel in or out using the lag nuts on the tensioning bolt.
3. Re-tighten the 2 bolts.

**Figure 2-52: Tensioning Assembly for Powered Skewed Conveyor Belt**

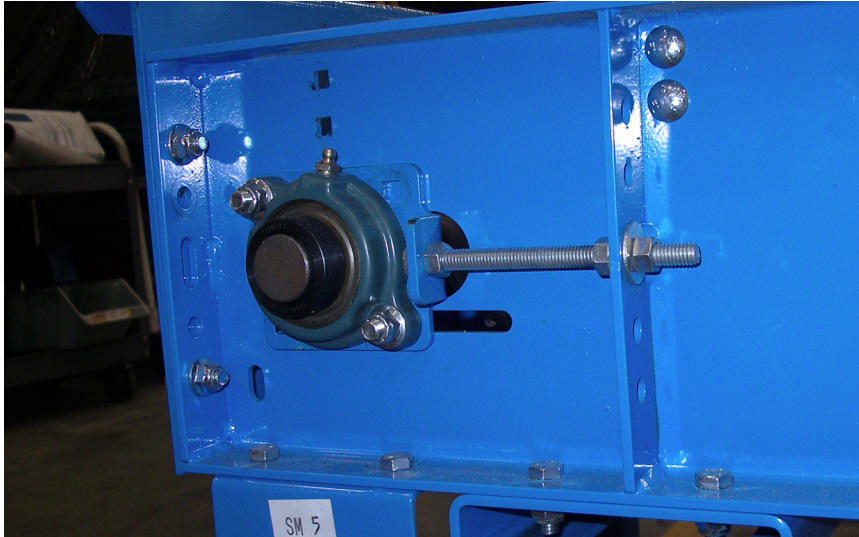



## **Adjusting Sheaves Supporting the Belt**

If the belt tension seems correct, but the belt is not making consistent and smooth contact with the rollers, adjust the sheaves that support the belt (located under the rollers) using this procedure. The belt should make just enough contact to drive the rollers, but not be too tight.

1. Determine which sheaves need to be raised or lowered.
2. Loosen the bolt in the middle of each sheave needing adjustment.
3. Adjust the location of each sheave in its slotted hole, then tighten each bolt.

## SECTION 3: PNEUMATICS & ELECTRICAL

### Pneumatic System

|   |  |
|---|--|
|   |  <b>CAUTION</b>   |
|  | <p><b>HIGH PRESSURE HAZARD.</b></p> <p>To avoid injury, bleed all pressure from the lines before performing any maintenance on the pneumatic components!</p> |

### Pneumatic Components and Settings

The pneumatic system controls all of the components listed on page MT-134.

There are a minimum of 5 pneumatic regulators on this system. The main filter/regulator manages incoming air from the air source, keeping it at the pressure needed for the strongest pneumatic component on the system. It is the only regulator than needs to be connected to an air source. Some components have their own regulator to further reduce the pressure. See page MT-134 for the optimum pressure settings for each.

**Figure 2-53: Location of Main Filter/Regulator and Cooler Filter**

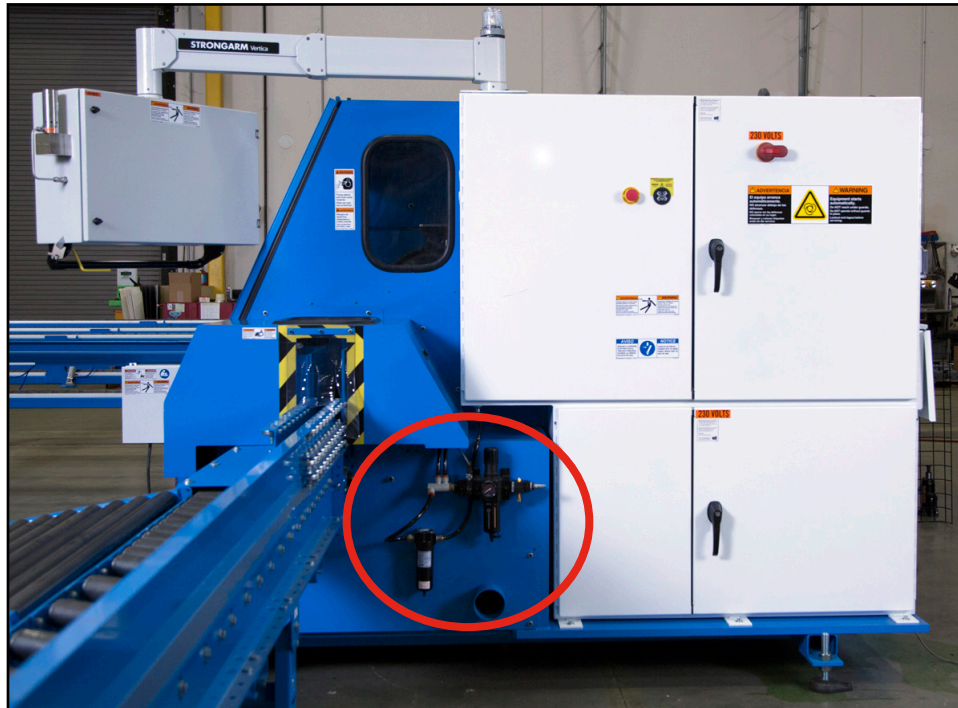







The system pressure should be 110 psi.

The lowest pressure the saw can safely operate at is 75 psi.

**Table 2-11: Overview of Pneumatic Components**

| Part Description              | Function  | Regulator & Valve Bank #     | PSI                     |
|-------------------------------|---|------------------------------|-------------------------|
| Auto Deck Pusher              | Pushes each board onto three load arms to be loaded onto the Infeed Rail.   | <b>system</b><br>valve 3     | 110                     |
| Auto Deck Lumber Stops        | Provides separation between two jobs on Auto Deck conveyor.   | <b>system</b><br>valve 7     |                         |
| Load Arms                     | Loads the lumber from the lumber feed system onto the Infeed Rail.  | <b>system</b><br>valve 5     |                         |
| Gripper Clamp                 | Holds the end of the board as it is traveling along the Infeed Rail.  | <b>system</b><br>valve 2     |                         |
| LASM Clamp                    | Holds each board inside the saw chamber and delivers each cut piece to the outfeed clamp.   | <b>system</b><br>valve 1     |                         |
| Touch Screen Enclosure Cooler | Keeps the touch screen enclosure at a constant temperature.   | <b>system</b>                |                         |
| Air Knives                    | Provides a curtain of air at the infeed and outfeed areas to contain dust.  | <b>system</b><br>valve 8     |                         |
| Side Clamp                    | Holds the lumber while entering the saw chamber.  | <b>side clamp</b><br>valve 4 | 30 clamp                |
| Top Clamp                     | Holds the lumber flat while entering the saw chamber, applied pressure from the top.  | <b>top clamp</b>             | 110 unclamp             |
| Outfeed Clamp                 | Holds the lumber while exiting the saw chamber.   | <b>outfeed</b><br>valve 6    | 60 clamp<br>110 unclamp |
| Printer                       | Prints identification on board for each cut piece using air powered print heads.<br><b>SETTING THIS PRESSURE HIGHER THAN RECOMMENDED WILL DAMAGE THE PRINT HEADS!</b> | <b>printer</b>               | 12                      |

## Replacing the Filter Element on the Main Regulator

|   |  |
|---|--|
|  |  <b>CAUTION</b>   |
|   | <p><b>HIGH PRESSURE HAZARD.</b></p> <p><b>To avoid injury, bleed all pressure from the lines before removing the filter guard.</b></p> <p><b>Ensure that the filter guard is securely attached to the regulator body before returning pressure to the lines.</b></p> |

All regulators for this system can be purchased directly from MiTek.

The main regulator has a filter element that must be replaced or cleaned every 6 months. Refer to Figure 2-59 on page MT-140 to see the components of this assembly.



1. When replacing the filter element, the system cannot be pressurized. Bleed the pressure from all the lines and ensure the gauge reads “0” before unscrewing the filter guard.
2. Remove the bowl from the regulator body by twisting counterclockwise while pushing up on the filter bowl. Then pull down to remove the filter bowl from the body.
3. Unscrew the filter element and remove it from the regulator. Be sure to keep the spring and any other parts resting in the filter element.
4. Place the spring (and any other parts removed) into the new filter element.
5. Screw the new filter element in its place.
6. Clean the bowl with mild soap and warm water.
7. Place the bowl back onto the regulator body by pushing up and turning clockwise. Make sure it is securely attached before returning pressure to the lines.

**Figure 2-54: Main Filter/Regulator**





If the saw has a right-hand waste conveyor, the guard under the filter may need to be removed to replace or clean the filter element. Two (2) socket head cap screws hold the guard in place.



## Replacing Filter Element for Touch Screen Cooler

The touch screen enclosure cooler system uses the main regulator for system air pressure but it has a secondary filter. The cooler's filter element should be cleaned or replaced every 6 months following these steps:

|   |  |
|---|--|
|  |  <b>CAUTION</b>   |
|   | <p><b>FILTER ELEMENT BOWL MAY BE HOT!</b></p> <p><b>Wear gloves or wait at least 10 minutes after locking out power and air before unscrewing the filter element bowl.</b></p> |



1. Lockout/tagout all saw systems (pneumatic and electrical).
2. Unscrew the filter element bowl.
3. Unscrew the filter element from the head.
4. Clean filter bowl with soapy water.
5. Clean or replace filter element:
  - a) Clean filter element with naphtha and let dry before re-installing, OR
  - b) Install new element.
6. Screw the filter bowl back into to place carefully to avoid stripping threads.

**Figure 2-55:  
Cooler Filter**



## Adjusting the Overall System Pressure



Location of main filter/regulator is shown on page MT-66.

The main regulator keeps the system pressure correct. To adjust the system pressure:

1. Unlock the pressure adjustment knob on the Regulator by pulling it straight up.
2. Turn the knob clockwise to increase pressure or counterclockwise to decrease pressure.
3. Once the ideal system pressure is obtained, push handle down to lock in place.

Figure 2-56: Main Pneumatic Regulator

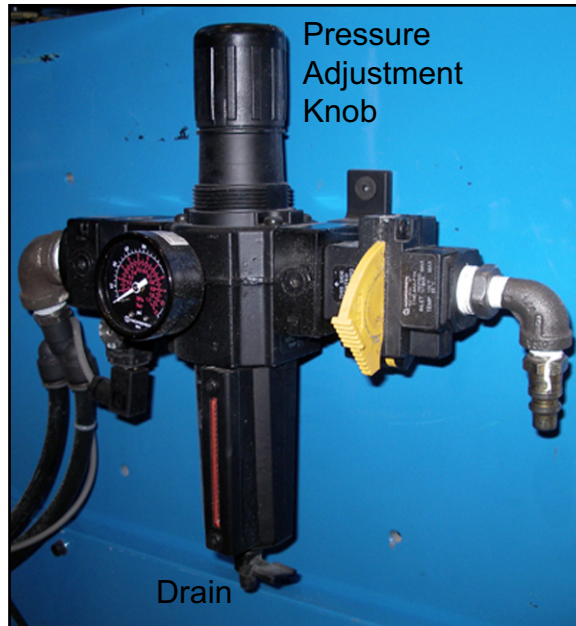

See page MT-134 for pneumatic pressure settings. Never exceed the recommended pressure settings.

## Draining Condensation & Sludge

At the bottom of the main regulator’s filter and the touch screen enclosure cooler’s filter is a condensation reservoir. In healthy pneumatic lines, only a few drips a day should expel from the lines. If excess water is gathering, investigate the reason for high condensation in the lines.

### Main Filter/Regulator

Open the valve shown in Figure 2-56 at the bottom of the reservoir every day to release condensation. It requires a 1/4 turn to completely open. After moisture has drained, close the drain and continue saw operation.

### Filter for Touch Screen Enclosure Cooler

At the bottom of the main regulator’s filter and the touch screen enclosure cooler’s filter is a condensation reservoir that automatically drains when needed. In healthy pneumatic lines, only a few drips a day should expel from the lines. If water is pooling on the floor, investigate the reason for high condensation in the lines.

|   |  |
|---|--|
|   | <b>NOTICE</b>  |
|  | <p><b>Water in the pneumatic system can cause significant damage to cylinders, valves, and the print head.</b></p> |

## Temperature Setting

The touch screen enclosure has a cooler to ensure a healthy environment for the touch screen computer. The cooler kicks on when the thermostat located inside the touch screen enclosure indicates that the interior of the enclosure is above the set point. The set point can be adjusted using the dial at the thermostat. It should be set between 85-90 degrees Fahrenheit.

**Figure 2-57: Cooler on Outside of Touch Screen Enclosure**



**Figure 2-58: Thermostat Inside the Touch Screen Enclosure**



## Adjusting the Main Pressure Switch

The pressure switch labeled in Figure 2-59 prevents the system from operating with inadequate air pressure. It sets the pressure at which the saw will no longer operate because it will not have enough pressure to perform its tasks. If the pressure drops below the minimum requirement, determine and fix the issue before attempting to cut boards.



If the system pressure drops below 75 psi, an error will appear on the saw's operator interface and the saw won't operate until the problem has been resolved.

The pressure switch should not need to be adjusted under normal circumstances. However, knowing how to adjust this setting may assist in troubleshooting. Minor adjustments can be made using an Allen wrench in the hole pointed out in Figure 2-59.

**Figure 2-59: Pressure Switch Adjustment on Main Filter/Regulator**

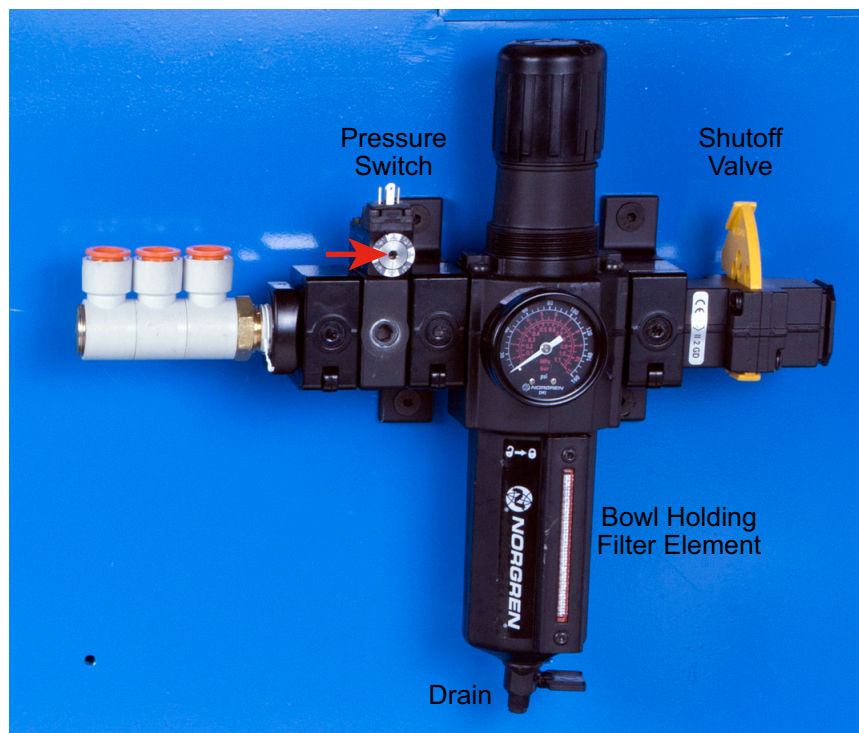

## Printer System Relief Valve

The printer's pneumatic system has a non-adjustable relief valve set at 15 psi. It is located on the front of the saw with the printer supplies.

The regulator that affects the printer system's pressure is located next to the relief valve. See page MT-134 for the maximum setting allowed. Exceeding this recommended setting will damage the print heads.

**Figure 2-60: Printer Relief Valve**

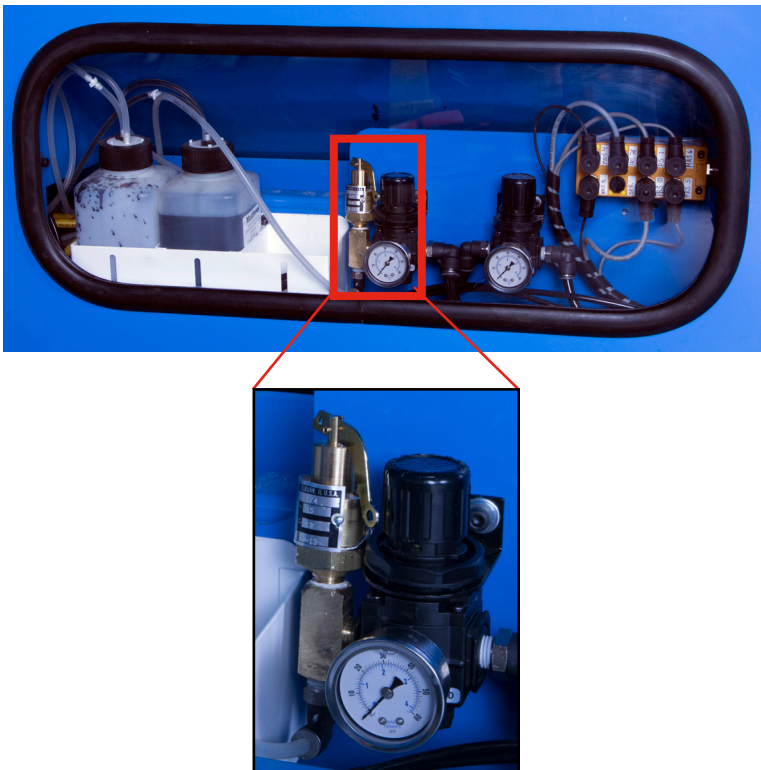



## Air Knives

Air knives provide a curtain of air at the infeed and outfeed areas to contain dust.



## Additional Pneumatic Maintenance

If a regulator is not operating at its optimum capacity, we recommend cleaning the regulator and replacing the O-rings, gaskets, diaphragm, and valve assembly. You can order a service kit including these preventive maintenance parts from the manufacturer.

Figure 2-61: Air Knife Inside Saw Chamber





## Using the Pull-Cord

A properly tensioned pull-cord will trip the E-stop switch when someone pulls it to approximately 1 in. from its rest position.

## Resetting the Pull-Cord Switch

Once a cable is pulled, the red light on the pull-cord switch that was activated illuminates. Reset the E-stop circuit by pressing the pull-cord Reset button. The pull-cord Reset button is labeled in Figure 2-62. The reset action must occur at the same switch that was activated.

## Adjusting the Pull-Cord Tension

To align the perimeter safety cable tension, turn the adjusting nut until the switch is centered in the switch alignment indicator.

Figure 2-62: Pull-Cord Switch Overview

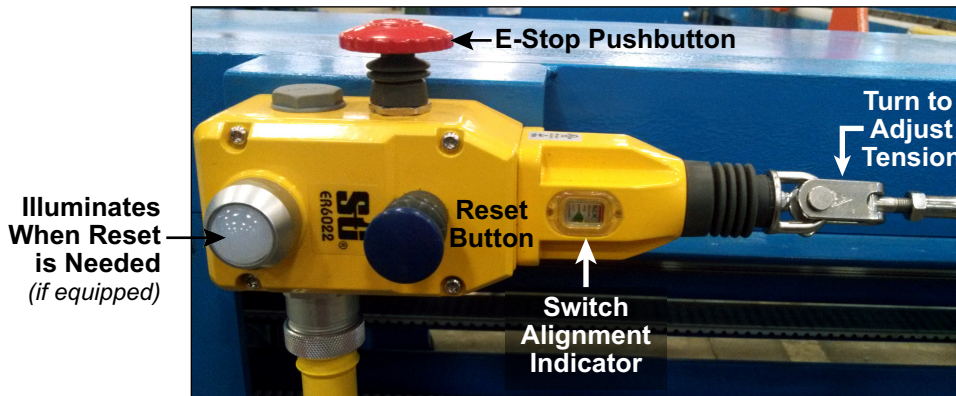

If saw will not operate,  
the switch may need to be re-aligned!



After resetting the pull-cord switch, the RESET button on the operator interface panel must also be pressed before the saw will operate.

## Main Electrical Enclosure

The major electrical components located in the top half of the main electrical enclosure are shown in Figure 2-63.

**Figure 2-63: Electrical Components in Top Half of Main Electrical Enclosure**

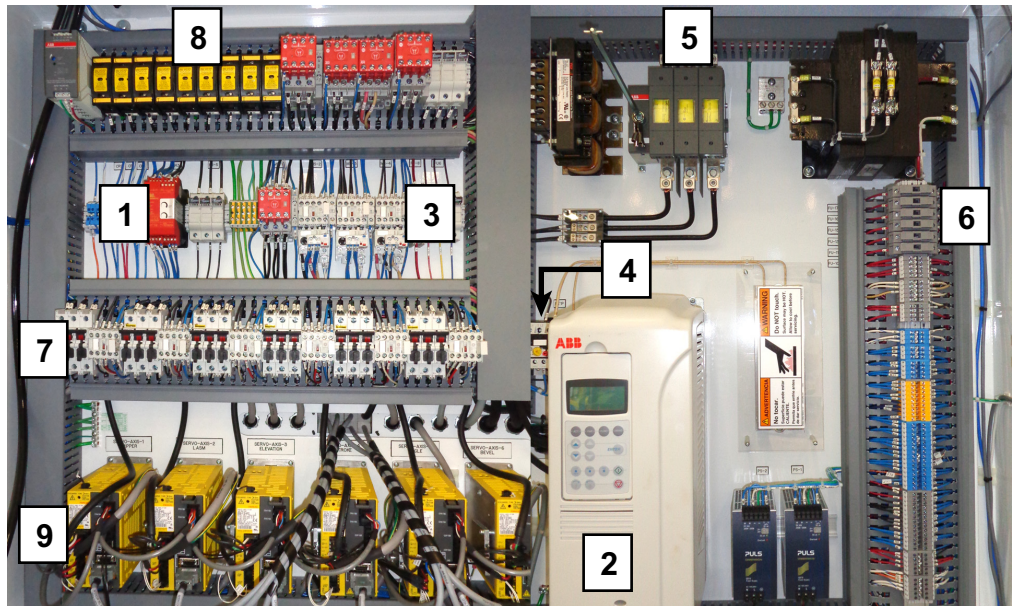

*PLC is located in the bottom half of the main electrical enclosure (not shown here).*

**Table 2-12: Cross-Reference for Figure 2-63**

| Label in Figure 2-63 | Component Name                             |
|----------------------|--|
| 1                    | Safety Motion Sensor                       |
| 2                    | VFD for saw blade                          |
| 3                    | Motor Starter Overloads                    |
| 4                    | Braking Resistor Overload                  |
| 5                    | Main Disconnect Fuses                      |
| 6                    | Terminal Block Fuses                       |
| 7                    | Branch Circuit Protection for Servo Motors |
| 8                    | Class J Fuses                              |
| 9                    | Servo Amplifiers                           |
| 10                   | VFD-2, for Waste Conveyor                  |
| 11                   | VFD-4, for Outfeed Chain                   |

## Understanding the Safety Features/Circuits

### Understanding the Safety Relay and E-Stop Circuit



See page MT-162 for more information on the E-stop module.

See page OP-107 in the Operation Manual to see the location of E-stops and other safety devices.

This section is valuable for any person responsible for operating or maintaining the equipment to better understand the safety features and functionality. It is absolutely necessary for maintenance personnel to read and understand this section.

#### LEDs

The Power LED is on when 24VDC power has been applied to the E-stop module. (A1 & A2)

**Figure 2-64: E-Stop Module Indicators, in Ready State**

|          |     |     |     |    |    |        |    |
|----------|-----|-----|-----|----|----|--------|----|
| 13       | 23  | X1  | X2  | X3 | X4 | 37     | 47 |
| A1       | S11 | S12 | S52 |    |    |        |    |
| ● Power  |     |     |     |    |    |        |    |
| ● Start  |     |     |     |    |    |        |    |
| ● CH1 IN |     |     |     |    |    | CHT1 ● |    |
| ● CH2 IN |     |     |     |    |    | CHT2 ● |    |
| ● CH1    |     |     |     |    |    |        |    |
| ● CH2    |     |     |     |    |    |        |    |
| S21      | S22 | S33 | S34 | Y1 | Y2 |        | A2 |
| 14       | 24  | Y39 | Y40 | 57 | 58 | 38     | 48 |

- Power (GREEN) - Illuminates when power on
- Start (GREEN) - Illuminates when S33-S34 is closed
- CH1 IN (GREEN) - Illuminates when channel 1 input is closed
- CH2 IN (GREEN) - Illuminates when channel 2 input is closed
- CH1 (GREEN) - Illuminates when K1 is closed
- CH2 (GREEN) - Illuminates when K2 is closed
- CHT1 (GREEN) - Illuminates during timing period
- CHT2 (GREEN) - Illuminates during timing period

#### Inputs

INPUT channels (CH1 IN and CH2 IN) are the input circuits that monitor the E-stop circuit for CLOSED/OPEN circuit path.

The Blade saw is considered a dual-channel E-stop circuit because it monitors 2 independent circuits on its input channels, and is consider a redundant self-checking safety circuit. When the power supply is switched on and the emergency stop, feedback, and reset circuits are closed, the unit is ready for operation.

When ALL E-stops are clear (Normally Closed contacts are closed) current travels from S11 to S12 for Channel #1 and from S22 to S21 for Channel 2. The internal safety circuitry confirms that both channels are continuously conducting a signal. The power flow of each input channel energizes the associated LED and once the E-stop module is ready will also energize the internal relay coils K1 & K2.

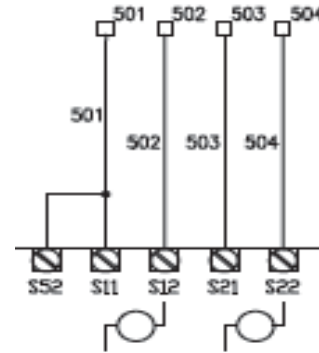
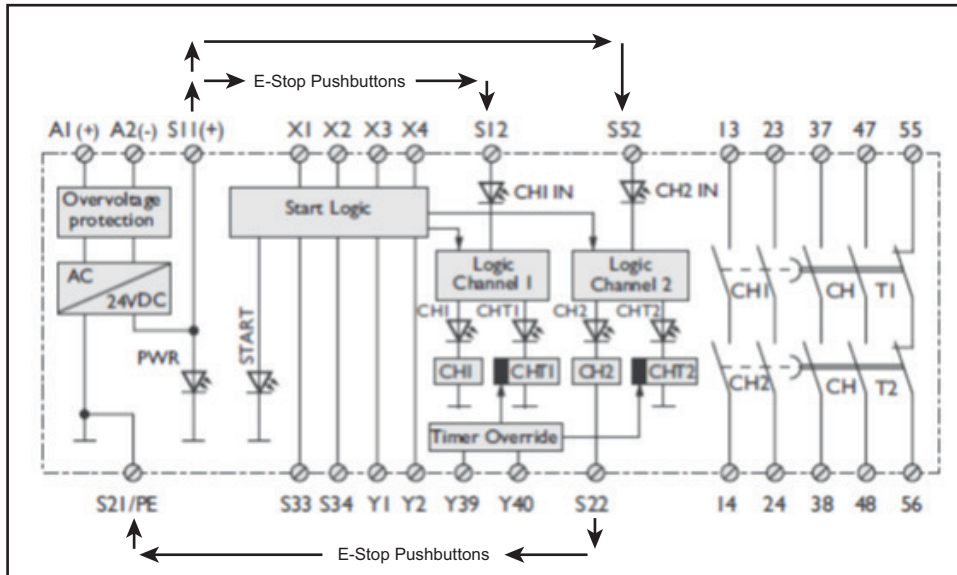

Figure 2-65 shows how the channel of normally closed contacts of all the E-stops complete the circuit path to turn on the LEDs and the relay coils K1(CH1) and K2(CH2).

**Figure 2-65: E-Stop Circuit**



In monitored reset mode, the reset circuit is interrogated each time the unit is switched on. If the reset contact is closed prior to an E-stop or power on, the E-stop module cannot enter into the “ready state”. This means the E-stop module requires the RESET PB to be open and inputs clear **before** you can reset/start the E-stop module.

**Figure 2-66: E-Stop Module Indicators, in Monitored Reset Mode**

|  |     |     |     |    |    |      |    |
|--|-----|-----|-----|----|----|------|----|
| 13   | 23  | X1  | X2  | X3 | X4 | 37   | 47 |
| A1   | S11 | S12 | S52 |    |    |      |    |
| <ul style="list-style-type: none"> <li>● Power</li> <li>● Start</li> <li>● CH1 IN</li> <li>● CH2 IN</li> <li>● CH1</li> <li>● CH2</li> </ul> |     |     |     |    |    |      |    |
|  |     |     |     |    |    | CHT1 | ●  |
|  |     |     |     |    |    | CHT2 | ●  |
| S21  | S22 | S33 | S34 | Y1 | Y2 |      | A2 |
| 14   | 24  | Y39 | Y40 | 57 | 58 | 38   | 48 |



Once the inputs channels are clear (no E-stops) and both CH1 IN & CH2 IN LEDs are on when the reset button is pressed the START LED will turn on. If the feedback circuit is closed, CH1 & CH2 will turn on and the corresponding relays will be energized. Once the Reset PB is released, the START LED will be off and the system is ready for operation.

**Figure 2-67: E-Stop Module Light Pattern When in READY STATE**

|  |     |     |     |    |    |      |    |
|--|-----|-----|-----|----|----|------|----|
| 13   | 23  | X1  | X2  | X3 | X4 | 37   | 47 |
| A1   | S11 | S12 | S52 |    |    |      |    |
| <ul style="list-style-type: none"> <li>● Power</li> <li>● Start</li> <li>● CH1 IN</li> <li>● CH2 IN</li> <li>● CH1</li> <li>● CH2</li> </ul> |     |     |     |    |    |      |    |
|  |     |     |     |    |    | CHT1 | ●  |
|  |     |     |     |    |    | CHT2 | ●  |
| S21  | S22 | S33 | S34 | Y1 | Y2 |      | A2 |
| 14   | 24  | Y39 | Y40 | 57 | 58 | 38   | 48 |

The E-stop module will energize the safety relays **only** if the feedback circuit is also closed.



Specific information on safety while the interlocked saw chamber door is open can be found on page OP-114 in the Operation Manual.

## Feedback Circuit

### Devices Monitored and Their Relationship

The feedback circuit assures the system that all devices monitored are in their “Safe State” before allowing the E-stop module to be in its Ready State.

The Chart below lists all the devices that are being monitored by the feedback circuit. If any of these device contacts are OPENED, then the E-stop module cannot be ready. If you are trying to reset the E-stop module and it will not reset, troubleshoot the most obvious first, check and make sure the Saw & Stroke doors are closed and the Safety switches are NOT physically unlocked. Any of these following conditions will prevent the E-stop module from resetting.

**Figure 2-68: Devices Monitored by the Safety Circuit**

| Device Monitored                  | Response Time |
|-----------------------------------|---------------|
| Servo Power Contactor             | Immediate     |
| Infeed Power Contactor            | Immediate     |
| Conveyor Power Contactor          | Immediate     |
| Waste Conveyor Contactor          | Immediate     |
| Incline Conveyor Contactor        | Immediate     |
| Outfeed Chain Contactor           | Immediate     |
| AXIS_6 Bevel Contactor            | Immediate     |
| AXIS_5 Angle Contactor            | Immediate     |
| AXIS_4 Stroke Contactor           | Immediate     |
| AXIS_3 Elevation Contactor        | Immediate     |
| AXIS_2 LASM Contactor             | Immediate     |
| AXIS_1 G Contactor                | Immediate     |
| VFD Power Contactor               | Delayed       |
| Saw Blade Contactor               | Delayed       |
| Saw Chamber Door Closed Switch    |               |
| Stroke Chamber Door Closed Switch |               |
| Immediate E-stop Aux Contact      |               |
| Timed E-stop Aux Contact          |               |



## Output Function of E-Stop Module

Once you understand the required inputs necessary to put the E-stop module into “Ready State” you are now ready to review the output functions of the E-stop module and the function of the Safety Circuit SR\_1 and SR\_2 and how they work together to create an immediate and a controlled stop of the Blade saw components.

SR\_1 is the Delayed Module. When the system is ready for operation, CH1 & CH2 relays are energized and the contacts of 13-14, 23-24, 37-38, 47-48 close and 55-56 open. When an E-stop is actuated there are 2 different stop conditions, Immediate and Delayed. The Delay should be set to the maximum setting @ 10 seconds.

**Figure 2-69: Immediate and Delayed Circuits**

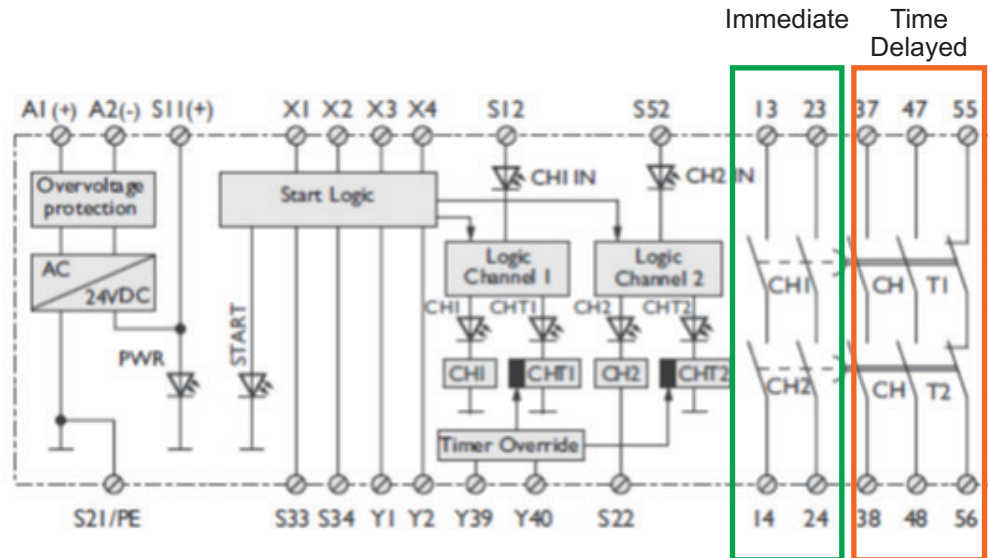

Pot Switch  
Setting at  
10 Seconds



## Immediate Module

The immediate contacts open as soon as an E-stop condition exists. The 2 immediate contacts control SR\_2, which controls all the devices & functions we want to shut down immediately upon an E-stop condition.

The immediate devices include:

- K2 Waste/Incline/Outfeed Power Contactor
- K3 Infeed Power Contactor
- K4 Servo Power Contactor
- LT\_1 E-stop Engaged Light
- LT\_2 Reset Light

The immediate functions include breaking the signal to the Skewed Conveyor VFD circuit, alerting the PLC of E-stop condition, alerting the Saw Blade VDF of E-stop condition, disabling the Servo Control Enable circuits, and preparing the Safety Feedback Loop for a RESET.

## Delayed Module

**Figure 2-70: Controlled Stop is Active**

|  |     |     |     |    |    |      |    |
|--|-----|-----|-----|----|----|------|----|
| 13   | 23  | X1  | X2  | X3 | X4 | 37   | 47 |
| A1   | S11 | S12 | S52 |    |    |      |    |
| <ul style="list-style-type: none"> <li>● Power</li> <li>● Start</li> <li>● CH1 IN</li> <li>● CH2 IN</li> <li>● CH1</li> <li>● CH2</li> </ul> |     |     |     |    |    |      |    |
|  |     |     |     |    |    | CHT1 | ●  |
|  |     |     |     |    |    | CHT2 | ●  |
| S21  | S22 | S33 | S34 | Y1 | Y2 |      | A2 |
| 14   | 24  | Y39 | Y40 | 57 | 58 | 38   | 48 |

Timing lights are now on showing delay is active.

The Delayed contacts are what we are going to consider as the *Controlled Stop Function*. When an E-stop condition happens, the delayed contacts will hold their current state for the time set by the E-stop module and let the controlled devices and functions come to a controlled stop.

On the Blade Saw, there is only one function, and that is the control of stopping the saw blade. The device contactors MS\_1 and K1 need to stay engaged while the signal to the VFD alerts the VFD to start its Emergency stop routine inside the VFD parameters. Once the time of the delay has elapsed, the E-stop module will open/close all the delayed contacts and the safety feedback loop will be ready for a reset of the E-stop module.

## Understanding the Door Lock Safety Circuit

The door safety switches are electromagnetic devices for guard locking. They provide protective guarding of dangerous movable axis and motion on the saw. When the door is shut, the actuator is automatically locked into the safety switch. The control system will allow the operator to open the door as long as the machine is in a safe state and there is power to the machine.

**Figure 2-71: Door Switch Actuator Stages**

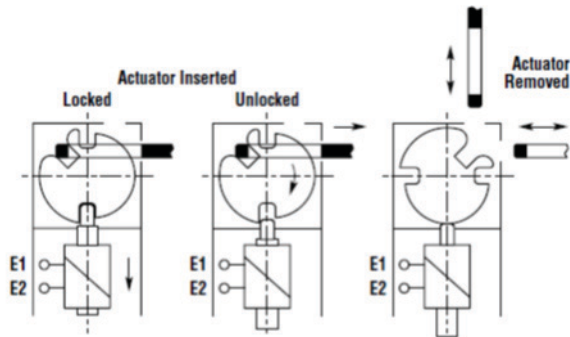

When the actuator is LOCKED within the Safety Switch, the 2 safety contacts (21-22) and (41-42) are closed allowing power to flow through the circuit that is attached to these two closed contacts. Looking at the physical cam itself in Figure 2-71, the locking pin of the solenoid is up in the cam, as shown in the diagram labeled Locked.

**Figure 2-72: Door Switch Circuits Shown Locked and Unlocked**

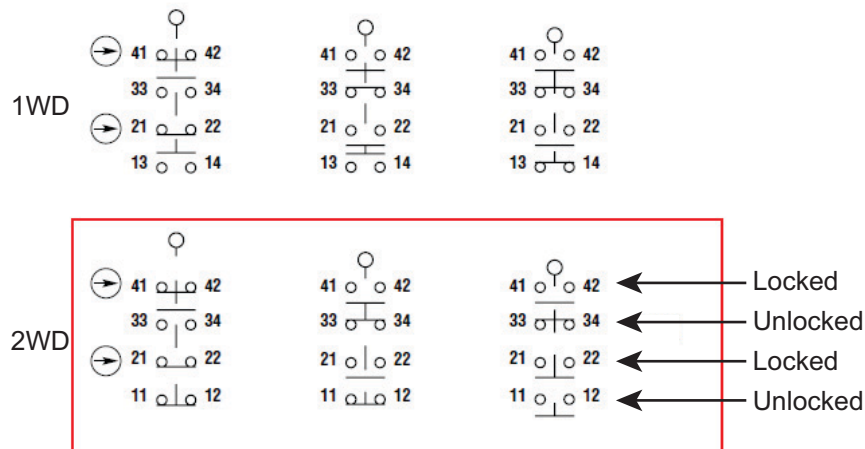

When someone physically unlocks the switch or the control system unlocks the switch, notice how the contacts respond as well as the physical cam. The locking pin of the solenoid is pulled down and out of the cam. See picture “Unlocked”. Safety contacts (21-22) and (41-42) are opened and contact (33-34) is now closed which tells the control system the door is UNLOCKED. Notice also the Door Closed contact is still closed because the actuator is still in the switch body.

When the physical door is opened, the actuator is removed from the switch and the Door Closed signal is now open, telling the control system that the physical door of the machine has been opened.

**Figure 2-73: Door Switch Control**

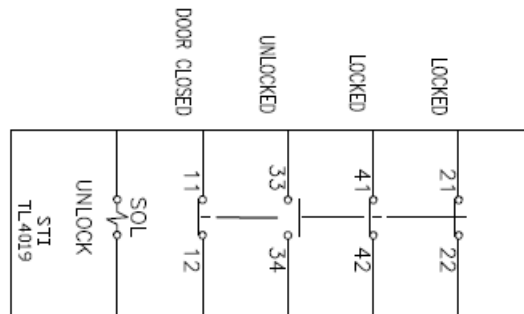

Figure 2-72 shows the electrical representation of the control inside the safety switch that will connect to the safety monitoring relay and the control system. The “Door Closed” circuit of both the Saw Chamber and

the Stroke Chamber safety switches are embedded into the Feedback Circuit on the main safety level. Review the section *Understanding the Safety Relay and E-Stop Circuit* starting on page MT-145 for further information on the Main Safety level.

The Door Unlocked circuit of both the Saw Chamber and the Stroke Chamber safety switch is sent to the PLC control system that also monitors the state of the doors. They are hardwired to the Safety Monitoring Relays (SR4 and SR5) which is another safety device that interlocks the Servos and the VFD Enable (Saw Blade) circuit.

Figure 2-74 shows the circuit of the safety module and how the safety door switch safety contacts are wired into the relay, the internal function of the relay, and the power path for the green LEDs on the module to turn ON. Notice how the redundant circuit works that both Safety Contacts “Locked” must be closed for the internal relays to energize. The Safety Monitoring Relay also watches the timing of both circuits. The maximum delay of circuit S12 before S13 is 300mS. If S13 circuit closes after the max delay, one or NONE of the LEDs will be on. The door must then be opened and re-shut to automatically re-test the circuit.

**Figure 2-74: Safety Monitoring Relay Circuit**

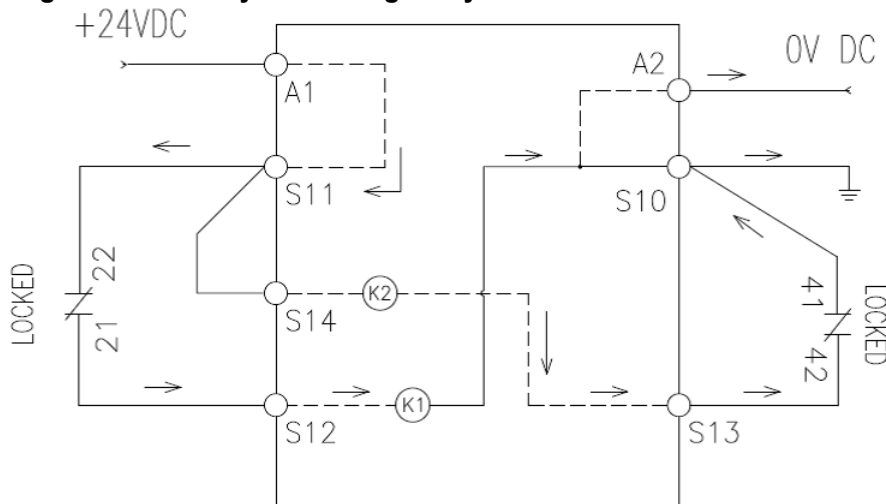

When both K1 (IN1) and K2 (IN2) LEDs are ON, the circuit is valid and the door is closed. The Safety Monitoring Relay will then close its safety contacts. (13-14), (23-24), and (33-34).

**Figure 2-75: E-Stop Module Assembly**

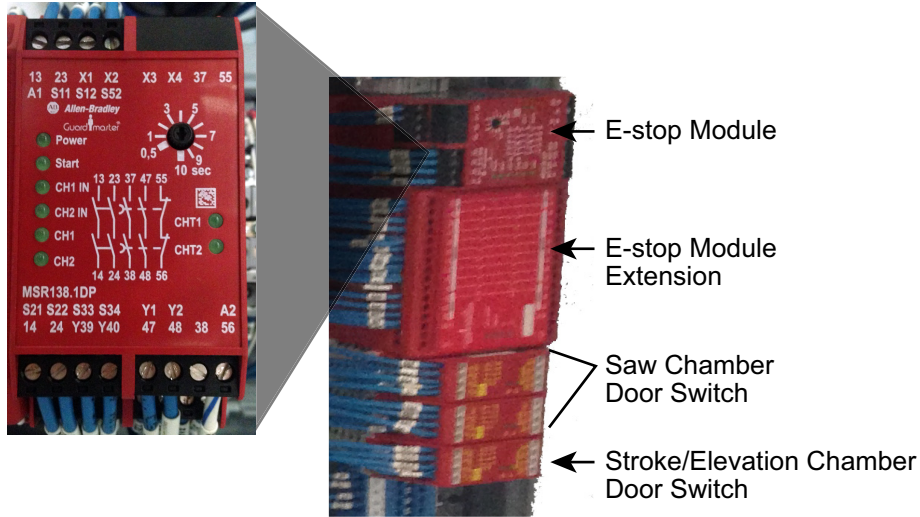

The Saw Chamber Safety Relay **SR4A** has an Expansion Unit that it also controls **SR4B**. When the door is closed, the contact (33-34) from SR4A becomes the input to SR4B and the IN1 & IN2 channels are then valid and the LEDs will turn ON. The Stroke Chamber Safety Relay is **SR5** and works exactly like SR4A.

The circuit of both the Saw Chamber and the Stroke Chamber Safety Monitoring Relay is embedded into the main circuit on the main safety level and completes the interlock of the Servo Enable and VFD Enable (Saw Blade) power sections.

The Drawing below represents ALL the Safety Contacts from all the different safety relays that must be valid before a function is capable of operating. This covers all safety relays on the Blade Saw except SR3, which is the motion detection of the spinning blade.

When these safety input channel lights on ON, the corresponding Normally Open contacts are closed and the Normally Closed contacts are open.

**Figure 2-76: Safety Contact Control**

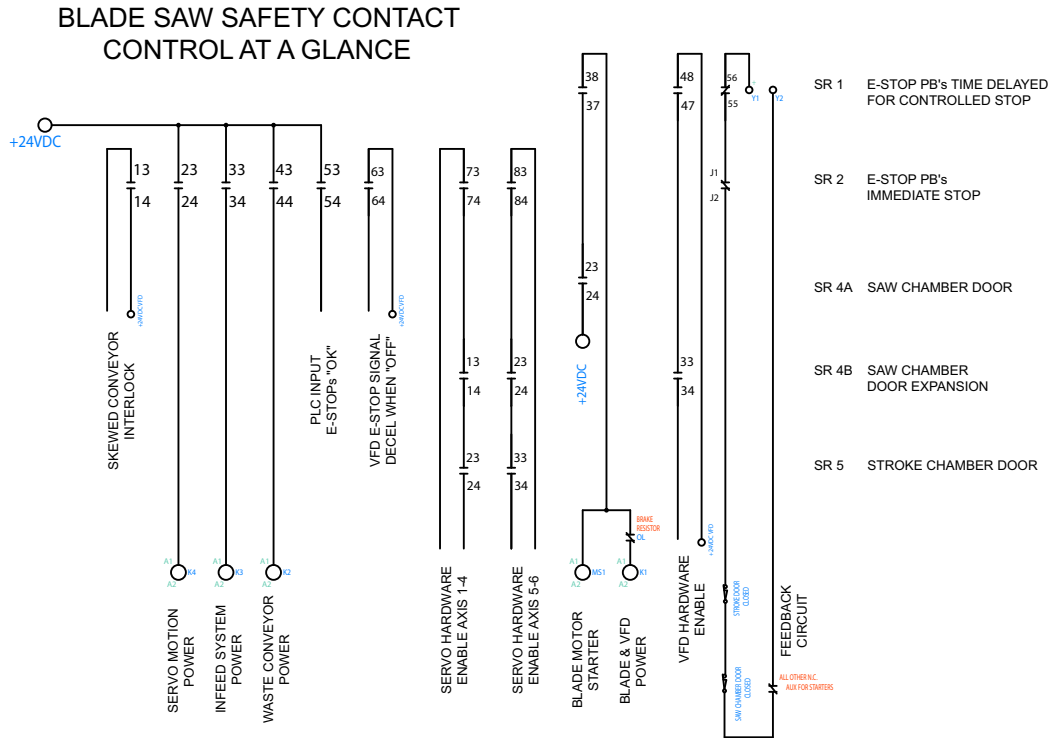

## PLC (Programmable Logic Controller)

### What the PLC Controls

The PLC is the brain between the mechanics and the electronics. LED lights display the active inputs and outputs. Among other things, it provides the following:

- Motion module
- Error recognition
- Error logging
- Communication method for sensors
- Remote capabilities
- Communication with printer
- Safety features



The PLC still has power when the E-stop circuit is tripped because the bottom half of the main enclosure is not part of the E-stop circuit.

### Operating and Maintaining the PLC

The PLC downloads the PLC software to the PLC's memory each time power is restored to the PLC. A battery may be present in the PLC, but it is not used.

**Figure 2-77: Bottom Half of Main Electrical Enclosure**

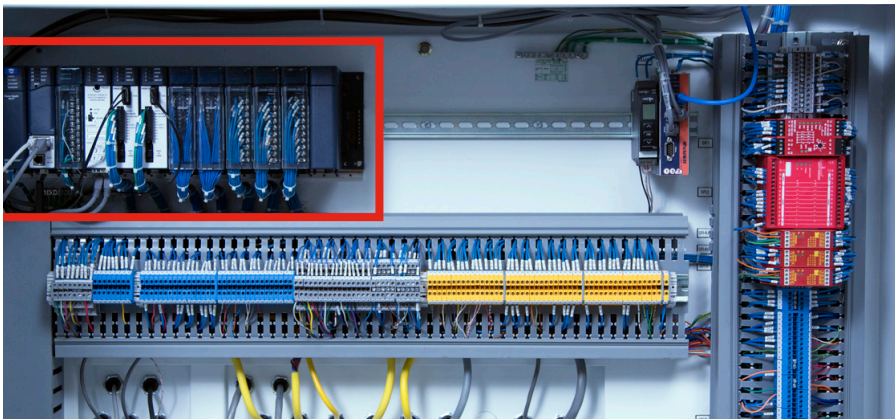

## Troubleshooting Tips for the PLC

If the PLC is not communicating with the saw, check the PLC rack for the presence of power. It is most likely that the 24 VDC power supply (PS 2) is not operational or the output is shorted to ground.



If there is power there will be many LEDs lit throughout the PLC rack. The "Power" light located on the left end of the PLC rack may still be lit even though a full 24 VDC is not present. If the PLC rack does not have multiple LEDs lit then a full 24 VDC is not present.

1. Test the power supply:
  - a) Disconnect (with main disconnect off) the positive output of the power supply.
  - b) Test (with main disconnect on) the output of the power supply
    - If 24 VDC is not present the power supply is not operational (assuming input AC power is present)
    - If 24 VDC is present then look for shorts in the wiring.
2. Check fuse FU\_25, and replace if it is blown.
3. Test the sensors:

Since this power supply also is used for sensors on the machine it is possible a sensor or its cabling is shorted. Unplug sensors one at a time until the PLC rack is powered again.



If the PLC problem is software related, contact MiTek Customer Service for the latest software version.



## Safety Motion Sensor

### Understanding the Safety Motion Sensor

The safety motion sensor measures when the blade motion has stopped. It reads EMF feedback on the 3-phase line to monitor movement. After the saw is installed or the Safety Motion Sensor is replaced, a tamper-proof seal should be placed over the 2 pot switches shown in Figure 2-78 to ensure the safety of the system remains intact.

Two separate channels are utilized to measure when there is “zero” motion present. Both channels must recognize “zero” speed at or close to the same time before the interlocked doors are released.



“Zero” speed, as defined by the safety motion sensor, is the amount of allowable movement determined by the sensor settings. The safety motion sensor was set to the most sensitive level during manufacturing. Never change this setting.

|  |   |
|--|---|
|  | <b>CAUTION</b>  |
|  | <p><b>NEVER TOUCH A MOVING SAW BLADE!</b></p> <p><b>The saw blade may still have slight coasting motion when the interlocked doors are allowed to open.</b></p> |

The safety motion sensor and a definition of the LED lights are shown in Figure 2-78. All 4 LED lights should be lit when the motor is a “zero” speed.

**Figure 2-78: Safety Motion Sensor in Top of Main Enclosure**

- A1/A2:** Supply voltage present on terminals
- Ch.1:** Zero speed detected by channel 1
- Ch. 2:** Zero speed detected by channel 2
- Zero Speed:** Zero speed detected by both channels within the time scope.

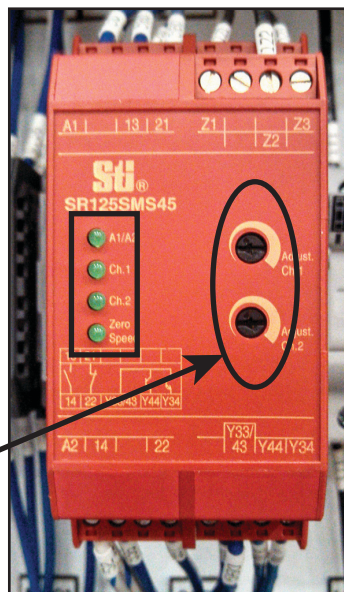

**Potentiometer (Pot) Switches**

**WARNING:** Do NOT adjust the pot switches unless replacing a module!

## Replacing the Safety Motion Sensor

If the safety motion sensor must be replaced, follow these instructions and the electrical schematic carefully.

### How It Works

When the motor is started, the internal relays K1 and K2 immediately drop in voltage, and open the output terminals 13-14 and close the output terminals 21-22.



When the motor is turned off and is coasting to a stop, it generates a residual voltage which is proportional to the motor speed. It is measured at the motor winding with the highest number of windings and then monitored by the input terminals Z1-Z2 and Z3-Z2. When the motor speed decreases and the voltage generated in the motor windings fall below the threshold value, both internal relays pick up, close the output circuit between terminals 13-14 and at the same time open the output circuit between terminals 21-22. The solid state output terminals Y43-Y44 switches and indicates *motor zero speed*.

If LED # 4 is not ON, the system will not know that the blade was stopped properly. This is a safety function and must be set properly anytime a safety motion sensor is installed.



### Installing the Safety Motion Sensor

1. Remove the damaged safety motion sensor from the main electrical enclosure. Its location is shown on page MT-144.
2. Install the new safety motion sensor into the main electrical enclosure.
3. Connect the windings of the motor to terminals Z1, Z2, and Z3. Z1 and Z3 are the input terminals, so they must receive the same information from the motor, at the same time.

|  |   |
|--|---|
|  <b>WARNING</b> |   |
|                 | <p><b>Adjust the safety motion sensor's sensitivity level before powering up saw.</b></p> <p>See page MT-159.</p> |

## Setting the Sensitivity Level of the Safety Motion Sensor

The potentiometer (pot) switches shown in Figure 2-78 on page MT-157 adjust the sensitivity of the safety motion sensor, defining “zero” speed.





Turning the potentiometers to the:

- Far left (counterclockwise) puts sensitivity at its maximum (10mV), which puts “zero” speed movement at its minimum.
- Far right (clockwise) places sensitivity at its minimum (100mV) which allows more movement at “zero” speed.

1. Check the minimum sensitivity by turning both potentiometer switches (shown on page MT-157) to the far **right** and verify that LEDs 1, 2, and 3 are lit.

a) If the lights are not on, reset the wiring using these steps:

1) Remove the 24 VDC power from the safety motion module at Terminals A1/A2 on the *BLADE* saw as shown in Figure 2-79.

|  |  |
|--|--|
|  |  <b>WARNING</b>   |
|  | <p><b>Pulling the terminal block switch bypasses the safety motion module. Only 1 operator is allowed in the restricted zone while the switch is pulled.</b></p> |

2) Run the saw blade and let it coast to a stop and ensure that all 3 lights come on.

**Figure 2-79: Removing Power Using the Terminal Block Switch**

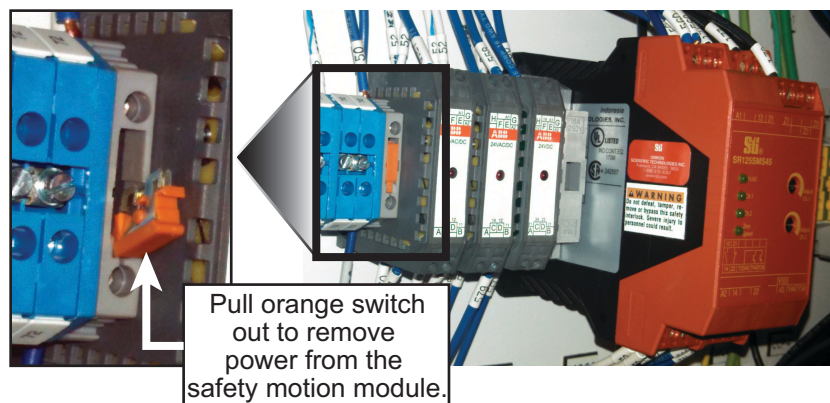



b) If the lights are on, continue to next step.

2. Check the maximum sensitivity by turning both potentiometer switches (shown on page MT-157) to the far **left**, at their most sensitive setting.

3. Run the saw motor, then let it coast to a stop while someone is watching the safety motion sensor LED lights.

4. Both channels (LEDs labeled Ch. 1 and Ch. 2) must turn on at the same time (<1 second of time difference).
  - If both lights do not turn on within 1 sec. of each other, go back to step 1a.
  - If both lights turn on within 1 sec. of each other, continue to the next step.
5. After the adjustment process is complete, close the terminal block switch shown in Figure 2-79 and allow the safety motion sensor to power up.
6. Place the tamper-proof seal that was shipped with the safety motion module over the potentiometer switches to ensure nobody adjusts them.

|   |   |
|---|---|
|   |  <b>WARNING</b>  |
|  | <b>CUT HAZARD.</b><br><b>Do not change the sensitivity settings of the safety motion sensor (pot switches) after it has been installed and adjusted properly.</b> |



## Troubleshooting Tips for Safety Motion Sensor

If either one of the channels on the safety motion sensor do not come on, try these troubleshooting tips:

1. Shut down the safety motion sensor and restart it. This may solve the problem.
2. If the problem persists, the blade motor cable may be faulty. To determine this:
  - a) Inspect the blade motor cable for nicks in the insulation that may have resulted in damaged wires.
  - b) Wiggle the cable while watching the safety motion sensor. It may cause the channel light to illuminate.
  - c) Use a meter to measure power at the leads.

If any of these steps provides evidence that the blade motor cable is faulty, replace the cable. It may be necessary to perform these steps several times if the problem appears intermittently.

3. Check SR\_3. If it powers up without CH1 or CH2 lit, the problem lies with the motor or power cable.
4. If the blade motor cable appears to be working, have a qualified electrician troubleshoot the entire system.

|   |  |
|---|--|
|   |  <b>WARNING</b> |
|  | <b>Never attempt to override a safety feature!</b>   |

## E-Stop Module



See page MT-145 for more information on the E-stop circuit.

The E-stop module monitors the E-Stop circuit for CLOSED/OPEN circuit paths. It is located in the bottom half of the main electrical enclosure.

The system monitors two independent circuits on its input channels. When the power supply switch is on and the E-stop, feedback, and reset circuits are closed, the unit is ready for operation.

In monitored reset mode, the reset circuit is interrogated each time the unit is switched on. If the reset contact is closed prior to an E-stop or power on, the module cannot enter into the Ready State. This means the module requires the RESET pushbutton to be open and inputs clear before you can reset/start the module.

Once the inputs channels are clear (no E-stops) and both CH1 IN and CH2 IN LEDs are on, the START LED will turn on while the reset button is pressed. If the feedback circuit is closed, CH1 & CH2 will turn on and the corresponding relays will be energized. Once the RESET pushbutton is released, the START LED will be off and the system is ready for operation.

When an E-stop is actuated there are 2 different stop conditions, Immediate and Delayed. The Delay should be set to the maximum setting of 10 seconds.

For more detailed information on the E-stop module and its circuit, refer to page MT-145 which will provide further explanation of the text just discussed.

**Figure 2-80: E-Stop Module LEDs Showing Channel Circuit is Valid**

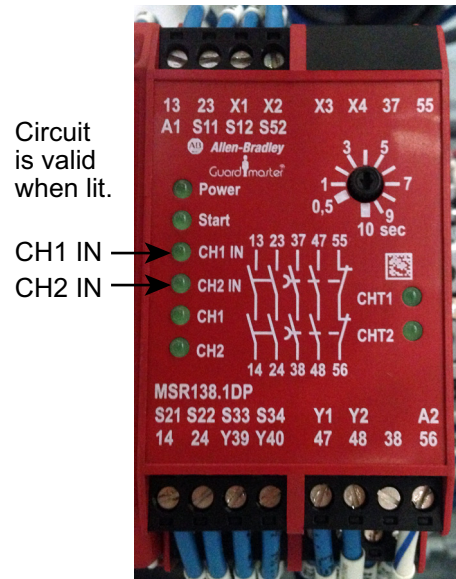

## VFD (Variable Frequency Drive)

**Figure 2-81:  
Primary VFD**



### Understanding VFDs



The location of the VFD is shown on page MT-144.

A VFD (variable frequency drive) is a type of motor controller that drives an electric motor by varying the frequency and voltage supplied to the electric motor.



A VFD is one of the first links in the electrical circuit, so verifying voltage in and out of the affected VFD is always a good first step in an electrical troubleshooting process.

This machine has a primary VFD and various additional VFDs to control specific components. Refer to your electrical drawings.

### Setting VFD Parameters

Contact MiTek Machinery Division before attempting to reset any setting.

All errors will be reflected on the saw's touch screen so there is no need for an operator to monitor the VFD.

|  |  |
|--|--|
|  <b>WARNING</b> |  |
|                 | <b>Do not change VFD settings unless instructed by a MiTek representative. Serious electrical hazards may exist.</b> |

### Replacing a VFD (Variable Frequency Drive)

The VFD must be ordered through MiTek because it needs to be programmed before it can be used.



## Overloads



For cleaning dust out of overloads, see page MT-70. Failure to follow these guidelines may result in damage to the contacts.

### Motor Starter Overloads

Motor starters turn motors on and off. Overloads are usually mounted to the output side of the motor starter and act as safety switches.

#### Why Motor Starter Overloads Trip

The air temperature around the saw should never exceed 110°F. In high ambient temperatures, the motors are unable to dissipate heat effectively. When the temperature of the motor windings exceeds a preset value, the motor overload will automatically shut down the motor to prevent it from burning up. Do not make any adjustments to the motor starter overload settings.

#### Resetting Motor Starter Overloads

If the overload trips occasionally, it is not a problem and can easily be reset. See Figure 2-82 when resetting a motor starter overload. If frequent overload trips occur, there may be a serious problem with the motor or electrical system. A qualified electrician should determine and correct the problem.



**Figure 2-82: Resetting a Tripped Motor Starter Overload**

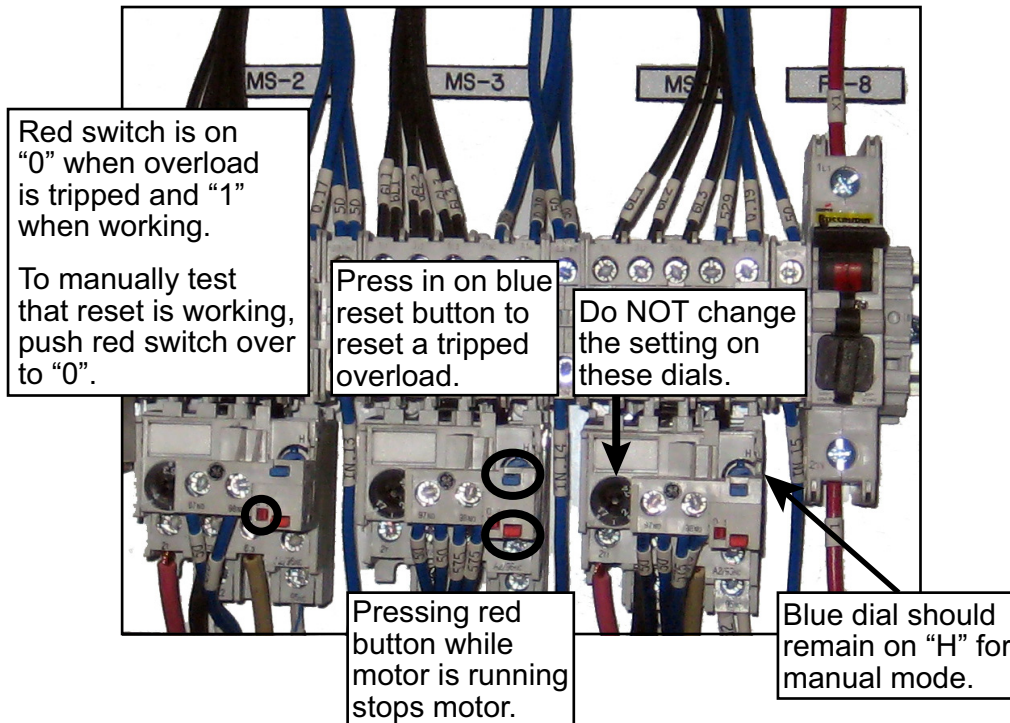

## Braking Resistor Overload for Saw Blade



Dynamic braking resistors are used on AC variable frequency drives (VFD's) to dissipate energy that is produced in the motor as the drive provides braking torque to stop the motor.

If the overload trips occasionally, it is not a problem and can easily be reset. See Figure 2-83 when resetting a tripped braking resistor overload. If frequent overload trips occur, there may be a serious problem with the electrical system. A qualified electrician should determine and correct the problem.

**Figure 2-83: Resetting a Tripped Braking Resistor Overload**



See the location of this overload on page MT-165

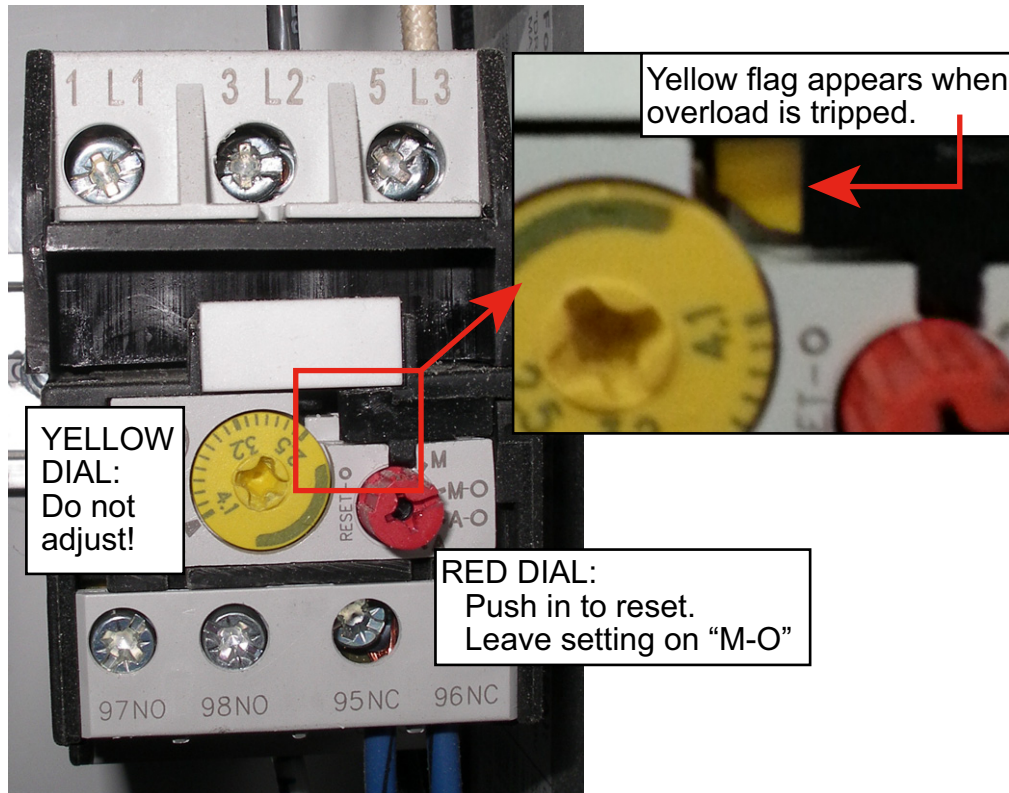

## Securing the Profinet Module

The Profinet module is used to communicate from the PLC to the VFDs. It is located in the main electrical enclosure and must be secured properly to avoid component damage. Failing to secure the Profinet Module may cause it to overheat and shut down the saw. Follow Figure 2-84 to locate the screw and screw hole.

**Figure 2-84: Profinet Module**

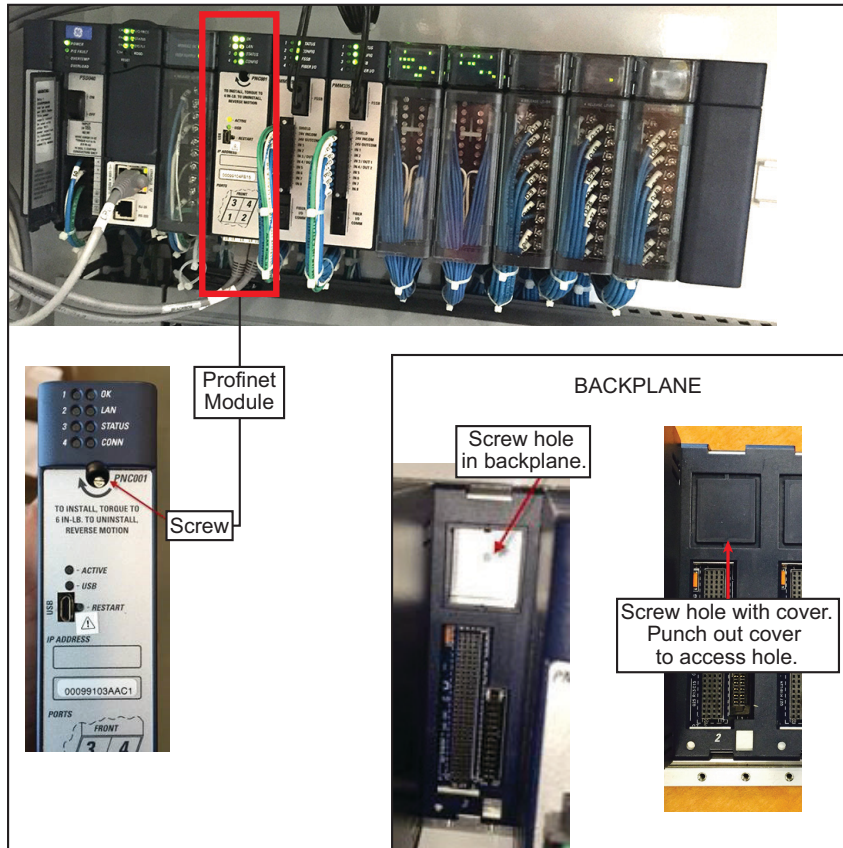

## Inputs

The inputs shown in Figure 2-85 are in the bottom half of the main electrical enclosure. A jumper is required between Input 1/5 and 1/6.

**Figure 2-85: Jumper Between Inputs 1/5-1/6**

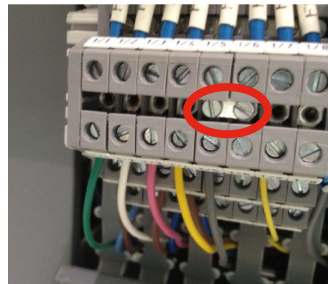



## Fuses

### Main Disconnect Fuses (3-Phase Power)

The fuses located at the saw's point of incoming 3-phase power in the main electrical enclosure are shown in Figure 2-86.

**Figure 2-86: Main Disconnect Fuses on Saw**

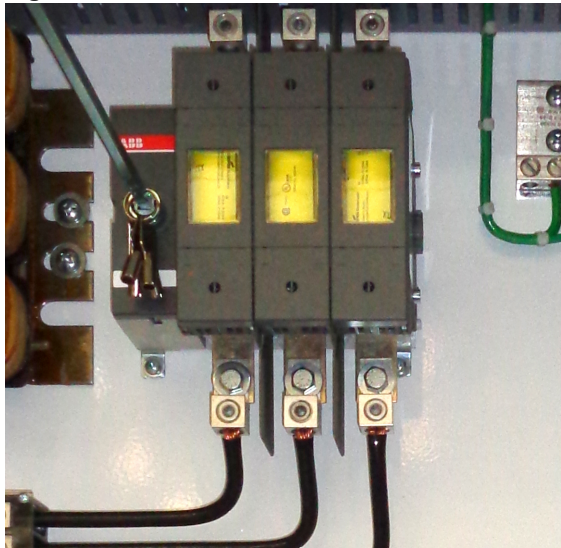

The Auto Deck staging conveyor has its own disconnect switch, but the fuse protection is handled inside the saw's main electrical enclosure with the same fuses used by the saw (shown in Figure 2-86). The Auto Deck's main enclosure is shown in Figure 2-87.

**Figure 2-87: Auto Deck Disconnect Fuses**

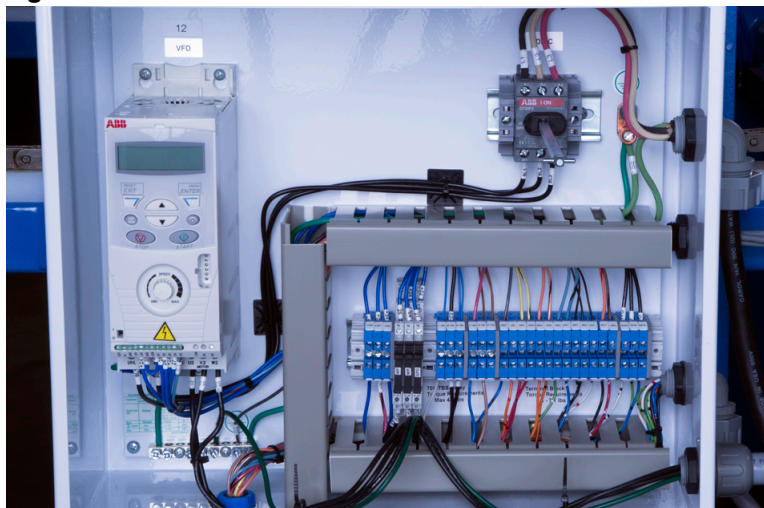

## Terminal Block Fuses



Some terminal blocks have fuses on top of them. To replace the fuse, pull out on the fuse box circled in Figure 2-88. Remove and replace the fuse, then push the fuse box back onto the terminal block.

**Figure 2-88: Fuse on Top of Terminal Block (view from side)**



## Branch Circuit Protection for Servo Motors



Each servo motor has a branch circuit protection fuse. See Figure 2-89 to replace the fuses.

**Figure 2-89: Replacing a Servo Branch Circuit Fuse**

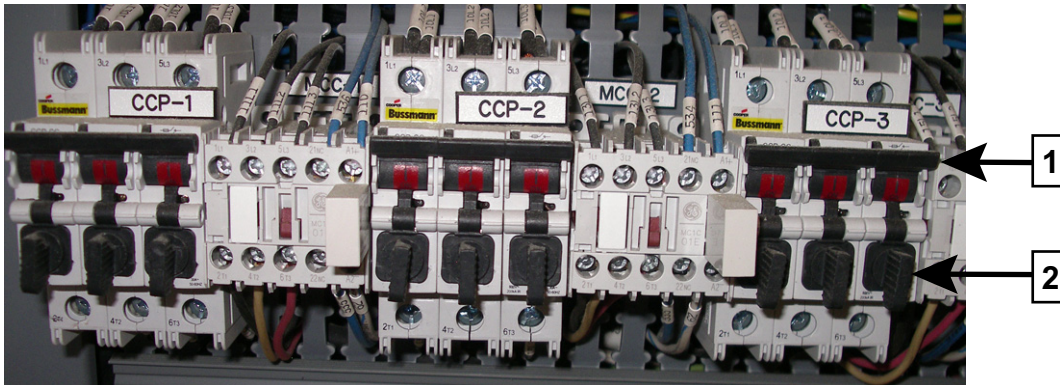

1. Pull down black bar to open circuit.  
*Red markings turn green to indicate it is safe to remove.*
2. Turn black knob counterclockwise.  
*Fuse pops out of assembly.*

## Class J Fuses



To replace the fuse in a class J fuse, pull out on the black box assembly (several are shown in Figure 2-90). The fuse comes out with the black box assembly. Replace the fuse and push the black box assembly back into place.

**Figure 2-90: Safety-J Fuses**



## Printer Fuse

To replace a printer fuse:



1. Turn the knob circled in Figure 2-91 and pull out the fuse holder to remove a faulty fuse.
2. Replace the fuse and re-insert the fuse holder.

**Figure 2-91: Fuse on Control Unit**

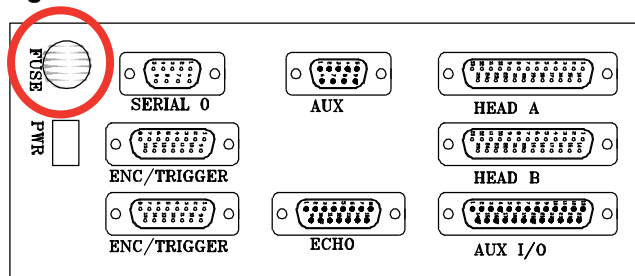

## Amplifier Fuse

Spare amplifier fuses are supplied with the installation package when the saw is first installed. Additional fuses can be ordered from MiTek. If the amplifier needs to be reset, pull fuse FU10 out, wait 10 seconds, then push it back in.



## Replacing the Blade Motor Cable



**Refer to...**

This procedure corresponds to SB214. The parts can be ordered in SB214KIT.

1. After performing lockout/tagout, disconnect the blade motor cable from the junction box inside the stroke/elevation chamber in this way:

- a) Locate the blade motor cable terminal points in the junction box. Newer saws look like Figure 2-92.

- b) Note and record the terminal label and wire label at each terminal point. The terminal points should be labeled 1T1, 1T2, and 1T3, plus the ground wire. If they are not labeled, label them in a way that will be useful when installing the new cable.

- c) Loosen the 2 clamps near the junction box that hold all wires routed through the stroke cylinder.

- d) Disconnect all 4 wires in the blade motor cable from the junction box.

**Figure 2-92: Junction Box in the Stroke/Elevation Chamber (on newer saws)**

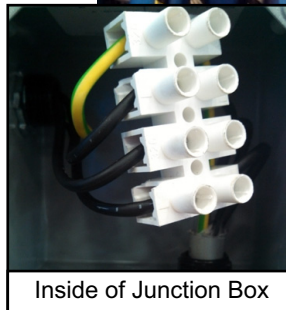
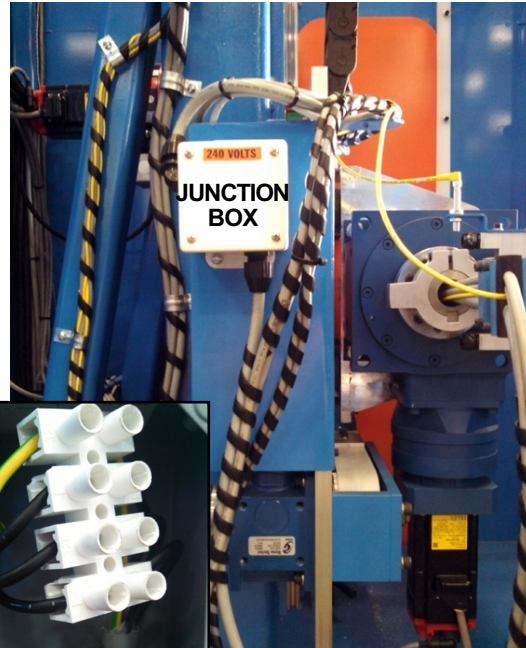

Do NOT remove the blade motor cable yet. It will be used to snake the new cable later in this procedure.



2. From the saw chamber, remove the blue guard shown in Figure 2-93, at the back of the saw blade assembly, so the grommet can be accessed.
3. Loosen the screws holding the grommet and the clamp (if present) shown in Figure 2-93.

**Figure 2-93: Remove Guard and Loosen Screws (in Saw Chamber)**

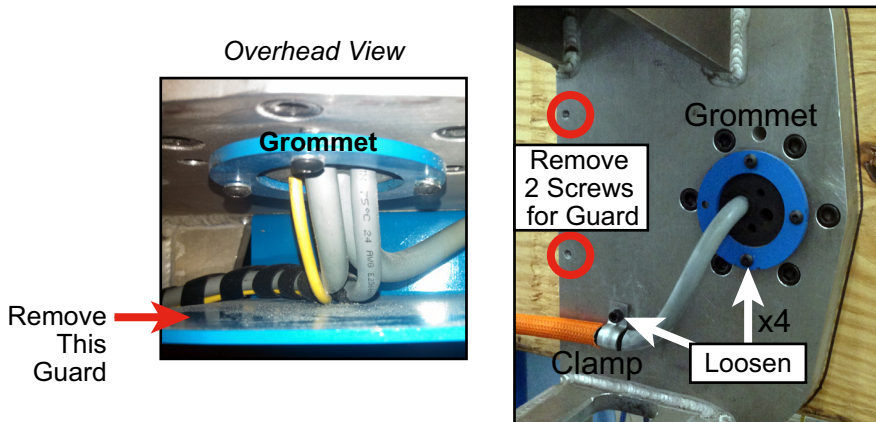

4. Inspect the clamp that is labeled in Figure 2-93
  - If a clamp is not present or it is damaged, install a clamp as shown in Figure 2-93.
  - If a clamp is present and undamaged, proceed to the next step.

**Figure 2-94: Overview**

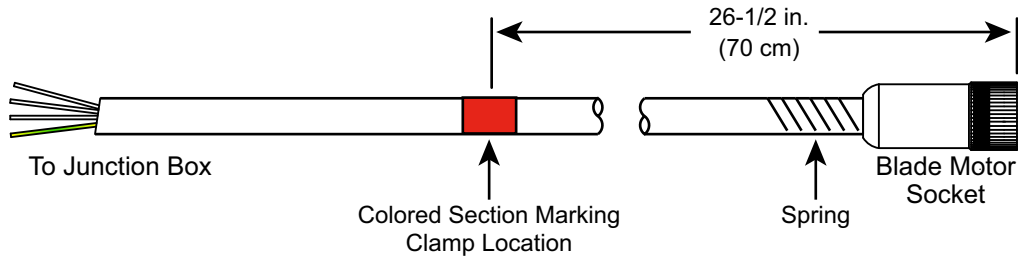

5. Place the protective covering and spring onto the cable using these steps:

- a) Pull the covering apart enough to fit the cable into it, then let the covering wrap back around the cable.
- b) Thread the junction-box end of the new cable through the supplied spring, and pull the spring along the length of the cable/ protective covering until it reaches the blade motor socket and is seated in the groove shown in Figure 2-96.
- c) Add a cable tie, near the narrow end of the spring to hold the protective covering in place.
- d) On the opposite end, the protective covering should extend just past the colored section marking the clamp location. The clamp will hold it in place on that end.

**Figure 2-95: Cable Assembly**

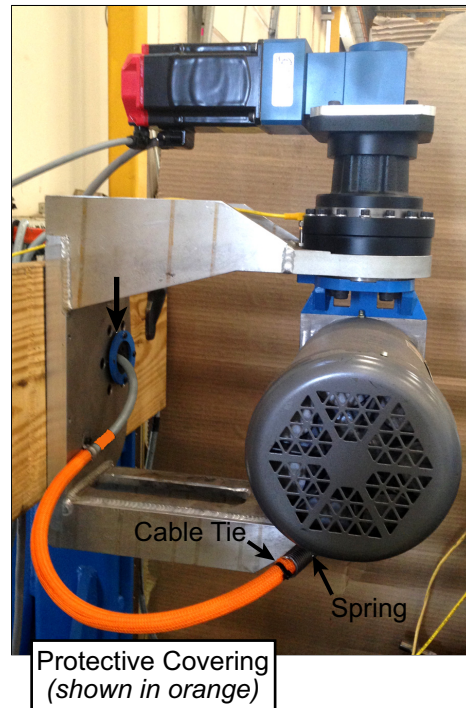

**Figure 2-96: Spring Installed on Blade Motor Socket**

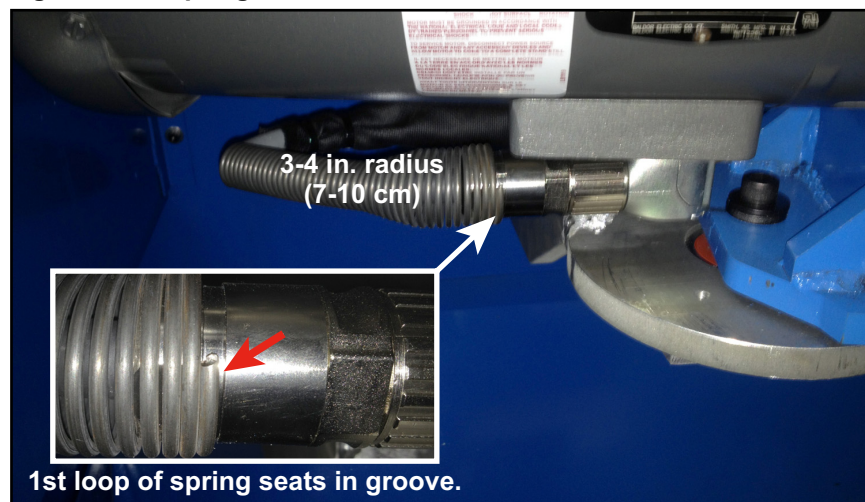



The socket and plug are shown in the close-up photo in Figure 2-96.

6. Install the blade motor cable by following these steps. Ensure there is no twist in the cable at each step. This part of the procedure is easier with two people.
  - a) Use the existing blade motor cable to snake a wire using these steps:
    - 1) From the stroke/elevation chamber, connect the junction-box end of the existing blade motor cable (disconnected from junction box on page 170) to a snake wire.
    - 2) From the saw chamber, disconnect the existing blade motor cable from the blade motor by unscrewing the retaining ring and pulling the socket out.

**Figure 2-97: Connection Point at Saw Blade Motor**



- 3) Also from the saw chamber, pull the existing (old) blade motor cable toward the front of the saw until the snake wire begins passing through the grommet.
  - 4) Still in the saw chamber, disconnect the existing (old) blade motor cable from the snake wire, while ensuring the snake wire does not pull back through the grommet. Discard the old blade motor cable.
- b) From the saw chamber, plug the new blade motor cable's socket into the blade motor:
    - 1) Align the keys in the blade motor socket with the motor plug, and push into place.
    - 2) Screw the retaining ring down until it is tight. It should bottom out on the rubber seal on the matting. Pliers may be required to tighten correctly.
  - c) Use the snake wire to pull the new blade motor cable through the grommet to the junction box using these steps:
    - 1) From the saw chamber, attach the junction-box end of the new blade motor cable to the snake wire.
    - 2) From the stroke/elevation chamber, pull the wire snake back toward the junction box until the new blade motor cable is pulled through the grommet.
    - 3) Still in the stroke/elevation chamber, disconnect the blade motor cable from the wire snake. Secure the cable so it doesn't pull through. It will be connected to the junction box in a later step.

d) Secure the new cable with the clamp using these steps:

- 1) From the saw chamber, straighten the protective covering so it is smooth and covers the colored section of the cable that marks the clamp location. It will provide additional protection from the clamp. The colored section can still be felt under the protective covering.
- 2) Tighten the clamp around the colored section and protective covering, ensuring there is no twist in the cable before or after the clamp.

e) Ensure the cable has a comfortable bend into the grommet, then tighten the grommet. The bend should look like the overhead view in Figure 2-93. If the bend is too tight or loose, push or pull more or less cable through the grommet.

f) Ensure the cable is routed as shown in Figure 2-98.

g) Re-install the blue guard that was removed. It is shown on page 171.

**Figure 2-98: Routing of Motor Cable**

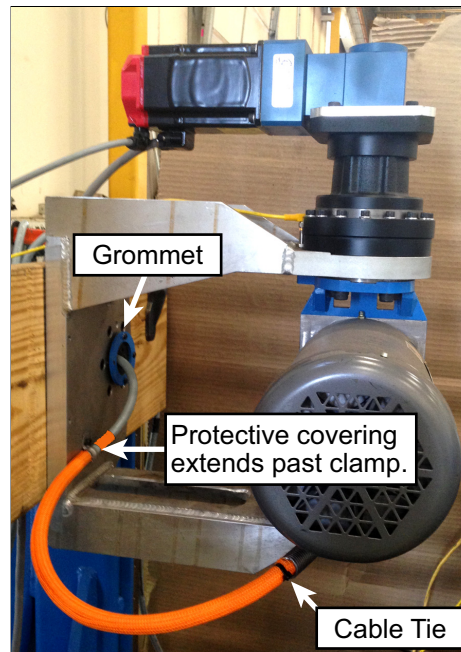

7. Once the cable is the correct length at the clamp and grommet, connect the other end of the cable to the junction box in the stroke/elevation chamber using these steps:
  - a) Access the junction box in the stroke/elevation chamber (shown in Figure 2-92):
    - From the left side of the saw, enter the stroke/elevation chamber OR
    - For better accessibility, remove the blue cover on the back side of the saw.
  - b) Locate the free end of the blade motor cable that was threaded through the grommet, and attach each conductor and the ground wire to the correct termination point inside the junction box, as listed in Table 2-13.





If the terminals are not marked by MiTek, they should have been marked as instructed in step b on page 170.

**Table 2-13: Termination Points Inside Junction Box**

| Wire Label          | Termination Point Label |
|---------------------|-------------------------|
| 1T1                 | 1T1                     |
| 1T2                 | 1T2                     |
| 1T3                 | 1T3                     |
| green/yellow ground | green/yellow ground     |

- c) Close the junction box and stroke/elevation chamber door.
- d) Reinstall the back side cover, if it was removed.

|  <b>WARNING</b>   |   |
|--|---|
| <br> | <p><b>Ensure all personnel are clear of machine before operating.</b></p> <p><b>Do not operate this equipment unless all guards and safety devices are secure and in working order.</b></p> |

8. Remove the lockout/tagout devices, ensure all personnel are at a safe distance, and test the stability of the new cable. Rotate the bevel axis from 0 to 180 degrees and ensure the following:
  - a) The blade assembly moves back and forth freely and the cable nor any part of it is interfering with the saw blade for entire 0-180 degrees rotation.
  - b) The cable has an adequate and smooth radius at the connector to avoid crimping (approximately 3-4 in.).
  - c) The cable stays within the slot on the aluminum housing for entire 0-180 degrees rotation.
  - d) The quick disconnect connector points towards the back of the motor and does not rotate when the bevel rotates. A slight movement is acceptable.
  - e) Ensure that the protective wrap is secure and not slipping.
  
9. Test the blade rotation:
  - a) Place the blade in home position.
  - b) Start the blade motor and ensure the blade is rotating toward the operator.
  - c) If it is rotating in the wrong direction, the wires are connected incorrectly in the junction box. Connect them as shown in Table 2-13.



## Saw Computer and Electrical System



A monitor, computer, hard drive, or any other electronic device must be purchased through MiTek. Proprietary software must be downloaded by MiTek. MiTek can not support nor guarantee any components purchased elsewhere.

### Touch Screen Computer Warranty

The touch screen computer has a limited warranty through the original manufacturer. The warranty instructions were provided in a separate document when the saw or latest computer was purchased. MiTek purchased the computer and transferred the warranty to the end user's name (or company name) at the time of installation.

For computer operating system or hardware issues, your own Information Technology department should be able to help.

Before calling the original manufacturer for technical help, gather the following information:

- Service tag number
- Express service code
- Model name
- Model number
- Operating system

### Replacing a Hard Drive

If you replace the computer's hard drive or wipe it clean, all software specific to the saw will need to be loaded again. Contact MiTek Machinery Division Customer Service to download the necessary software and apply the existing license.



## Replacing the Computer

When a new computer is needed, it must be purchased through MiTek. Our technicians will load the necessary software before shipping it. In addition to replacing the unit, refer to the section starting on page MT-179 for renewing the software licenses.

To replace the touch screen computer:



The cable connection points are shown in the Installation Manual on page IN-88.

1. Power down the touch screen computer and wood processing system. Instructions are in the Operation Manual on page OP-134.
2. Open the back door of the touch screen enclosure.
3. Remove each cable from the back of the touch screen computer, making note of the port location of each cable. Add labels to the cables if necessary.
4. Remove the damaged touch screen computer from the bracket, keeping all hardware. See Figure 2-99.
5. Install the new touch screen computer onto the bracket in the same manner that the damaged unit was removed, using the existing hardware when necessary.
6. Connect each cable to the new touch screen computer in the same manner as they were connected to the damaged unit. Note that port location and labels may vary slightly on touch screen computer replacements.

**Figure 2-99: Remove the Touch Screen Bracket Screws**



## Software

### Software Summary

The following software is used within this wood processing system to allow perfect communication and integration.

**Table 2-14: Summary of Software in Use**

| Software   | Physical Location   |
|--|---|
| <i>BLADE</i> software  | Touch screen computer   |
| Reports software   | Usually on office PC  |
| <i>Kepware</i> ™ software<br>(interface between <i>BLADE</i> software and PLC) | Touch screen computer   |
| PLC software   | PLC   |
| <i>Board Stretcher</i> optimizing software                                     | Usually on an office PC   |
| Software for optional lumber retrieval system                                  | Touch Screen computer,<br>only on saws integrated with<br>lumber retrieval system |

A number of things could cause one or more of the software licenses to require renewal or re-download, including the following:

- Re-imaging the hard drive
- Upgrading to a new computer
- Changing the user name
- Changing the domain
- Changing the computer name
- Disconnecting the saw computer from the network or leaving it off for more than 21 days

## BLADE Software License

The *BLADE* software license does not expire. If a hard drive is wiped clean or replaced, contact MiTek Machinery Customer Service for instructions on downloading the software to your saw computer.

The license could be deactivated for any of the reasons listed on page MT-179. If this occurs, the screen shown in Figure 2-100 appears when an active license for the *BLADE* software is not found. When it appears, enter the required information and press NEXT. If no active license is available, an error will be shown and you must call MiTek Machinery Customer Service to re-activate the software.

For licensing or operator issues with any of the software listed in Table 2-14, contact MiTek Machinery Division Customer Service. For licensing or software issues with *Windows* or any software supplied by the computer manufacturer, contact the computer manufacturer. See page MT-177 for computer warranty guidance.

**Figure 2-100: Screen at First Use of Computer on a Domain**

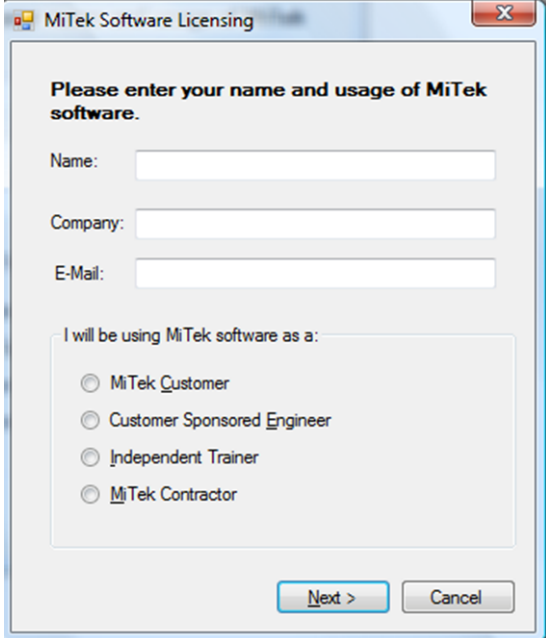

The image shows a Windows-style dialog box titled "MiTek Software Licensing". The main text inside the box reads "Please enter your name and usage of MiTek software." Below this text are three text input fields labeled "Name:", "Company:", and "E-Mail:". Underneath these fields is a section titled "I will be using MiTek software as a:" followed by four radio button options: "MiTek Customer", "Customer Sponsored Engineer", "Independent Trainer", and "MiTek Contractor". At the bottom right of the dialog box are two buttons: "Next >" and "Cancel".

## PLC Software

Occasionally, a PLC software update may be needed. MiTek will notify you if this becomes necessary and can upload it to the *BLADE* system using the eWON or web page.

## **Kepware Software: Installing**

Kepware software is the interface between the *BLADE* software and PLC software. If a hard drive is wiped clean or replaced, the Kepware software can be downloaded from the Kepware web site following these instructions. After installing the software, see page MT-182 for activating the license.



If the software is already downloaded, refer to page MT-182 to activate the license.

An emergency use license is also described there.

*This information was obtained from <http://www.kepware.com>.*

### **1. Install from the Kepware Website**

Navigate your browser to [www.kepware.com](http://www.kepware.com). If you have already created a My Kepware account, select My Kepware to login. Otherwise, select Sign Up to enter registration information. Upon completion, an email will be sent to the email address that was provided. To verify your Kepware registration, click on the link provided.

### **2. Sign Into My Kepware**

Enter your Email Address and Password. Then, click Login.

### **3. Choose a Product**

Under Product Downloads, locate and select the product of interest.

### **4. Save the Installation File(s) to Your Computer**

The File Download Security Warning dialog will be invoked. Click Save and then browse to the folder in which the installation file(s) will be saved. Click Save to proceed.

## Kepware Software: Licensing

There are several options for activating a license for *Kepware* software:

- Recommended activation process described on page MT-183. A valid Activation ID is required for this option.
- Demo Mode active for 2 hours.
- Temporary license active for 7 days.



If the software needs to be downloaded, refer to the section beginning on page MT-179.

If the software is present but not active, use one of these methods.

### 2-Hour *Kepware* Demo Mode

If the *Kepware* license is needed at a time when renewing the license is not possible, there is a Demo Mode where a trial license can be used for 2 hours at a time. At the end of the 2-hour period, the operator may start the 2-hour period over again. This can continue for as long as necessary.

To begin the Demo Mode period, select *Start Runtime Service* in the right-click menu shown in Figure 2-101. To extend the Demo Mode for an additional 2 hours, select *Stop Runtime Service*, then select *Start Runtime Service* again.

**Figure 2-101: Renewing the *Kepware* Demo Mode**

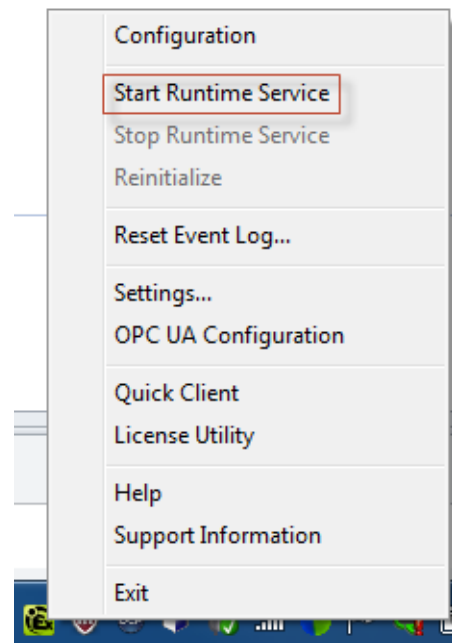

### Temporary *Kepware* License for Emergency Use

An Emergency ID is provided with each purchased permanent software license to be used in the event of a PC/system failure occurring outside of standard business hours. The emergency license can be activated through the licensing website from any internet-enabled computer, and will allow the product to run for a period of 7 days. The Emergency ID is a unique one-time use license: one must be used for each product that requires emergency activation. After using an Emergency License, users must contact Technical Support to discuss options for re-commissioning the application.

## Activating KEPServerEX Software License

When the *BLADE* wood processing system was first purchased, an Activation ID was assigned to the *Kepware* software. This ID helps *Kepware* track each license and prevent it from being used on more than one computer at the same time. If a hard drive is wiped clean or replaced, *Kepware* must reset the activation status of the Activation ID so it can be used on the new hard drive. If a completely new computer is purchased through MiTek, the license will be activated before it is shipped.



*Kepware* may need to reset the status of the Activation ID before it can be activated again on an existing computer.

*This information was obtained from <http://www.kepware.com>.*

The following process is required for activating a software license.

1. Open the License Utility on the Host Machine

Start|Programs|Kepware|KEPServerEX 5|

License|License Utility (default installation path)

2. Select *Manage Software Licenses*

Click Next to continue.

3. Select *Activate a Product*.

Click Next to continue.

4. In *Create Activation Request File*, enter the Activation ID, which is provided by Kepware with a purchased product. Then, click *Save to File...*

5. Save the Request File

The License Utility will then display a file-browse dialog, allowing you to save the generated request file, **activation\_request.txt**. Save the file, making note of its location. It will be sent to Kepware in the next step.

**Important:** An internet connection is required to activate a license. If the computer that the activated license will run on does not have internet access, users must copy the activation request file to a computer that does in order to log in to the web-based license portal (and generate the activation response file).

6. Launch the License Management Tools

In an internet browser, navigate to <https://my.kepware.com/mykepware/>. This will bring you to the My Kepware Portal. Returning users will be prompted to enter login information, whereas first users must create a *My Kepware Account* to continue.

7. Enter Registration and Activation Information

Once logged in, select Product Registration and Activation under the License Management Tools. Enter the registration and activation ID information, and then browse for the Activation Request File that was previously saved. Upload the request file and then click OK.

8. Save the Activation Response File

You will be provided with a link to download an activation response file called **response.txt** from *Kepware*. Save this file to the Host Machine and then return to the Manage Software License Activation dialog in the License Utility.

9. Browse for the Activation Response File

Next, click the *Import File* button. Browse to and select the downloaded activation response file. Then, click the *Open* button at which point the response file will be processed.

10. Restart Runtime Service: The runtime service should be restarted after activating a license to prevent the license from continuing to run in Demo mode. Access the Runtime Service using the right-click menu shown in Figure 2-101 on page MT-182

Note: On successful activation, the *View Licenses Page* will be displayed listing the activated products.

## KepServerEX5 Configuration

If using *KepServerEX* version 5, there may be an icon on the desktop or in *Windows* system tray. This icon is only needed if a MiTek representative instructs you to access the *Kepware* configuration program.

**Figure 2-102: Opening Kepware Configuration Software**

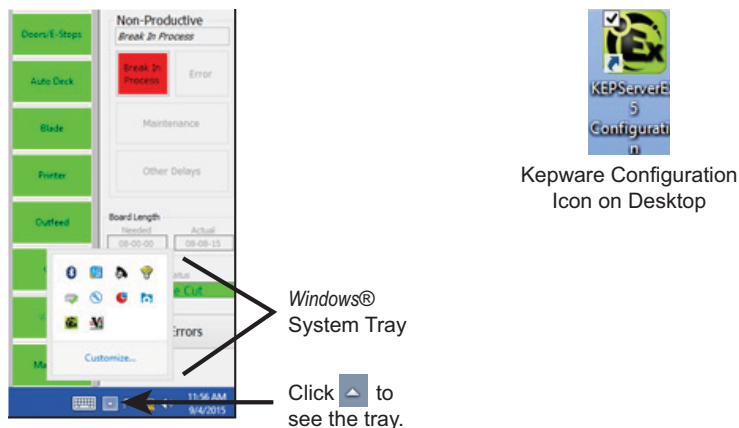



## Specific Profile Changes on the Saw PC

### Removing the Property Requiring a Keyboard

Certain profiles require that a keyboard be connected to start the saw. If receiving an error stating that a keyboard must be connected, either connect a keyboard or change the profile so it stops looking for a keyboard. To change the profile:

1. Plug in a keyboard to the Blade PC
2. When starting the computer press the F12 key to show a menu where the BIOS can be accessed.
3. Use the down arrow key to highlight *BIOS Setup* and press Enter.
4. Use the down arrow key to select *POST Behavior*.
5. Use the right arrow key to expand *POST Behavior*.
6. Use the down arrow key to select *Keyboard Errors*.
7. Use the Tab key to select *Enable Keyboard Error Detection*.
8. Press Enter to uncheck *Enable Keyboard Error Detection*.
9. Press the Tab key to select *Apply* and press Enter.
10. Select *Save* or *Save and Exit* using the arrow keys and press Enter.

### Removing the Property Requiring CTRL-ALT-DELETE

Some profiles require the Ctrl+Alt+Delete key sequence be used to log in which requires a keyboard.

1. Swipe in from the right side of the screen to display the Search selection and select.
2. Type in *netplwiz* and select the *netplwiz* with the graphic beside it.
3. Select the *Advanced* tab.
4. Deselect *Require users to press Ctrl+Alt+Delete*, and click OK.

## Networking eWON (Ethernet Switch)

It was recommended when the system was installed that two separate Ethernet lines be installed: 1 for file access and 1 for remote maintenance. All of the networking communication in this system goes through the eWON which acts as a hub so all Ethernet devices can talk to each other. These include the PLC and the saw's operator interface. The eWON is located near the PLC in the bottom half of the main electrical enclosure. It includes a remote maintenance feature referred to as *Talk to M*.

**Figure 2-103: Ethernet Switch (eWON)**



## Connecting the eWON

**Table 2-15: eWON Connection Descriptions**

| ID # in Figure 2-103 | 2016 Model               | Prior to 2016 Model            |
|----------------------|--------------------------|--------------------------------|
| 1                    | To touch screen computer | To touch screen computer       |
| 2                    | To PLC CPU               | To PLC CPU                     |
| 3                    | Ethernet switch          | VFD                            |
| 4                    | Customer's Ethernet      | Profinet PLC                   |
|                      |                          | Talk to M: Customer's Ethernet |



## Resetting the eWON

All eWON data (IP address, parameters, etc.) can be erased by pressing and holding the RESET button for more than 4 seconds (Firmware 6.0s3 or later). At this time, the *User* LED stops blinking and becomes solid red.

### Stopping in the Middle of the Reset

If the RESET button is accidentally held for more than 4 seconds, and the operator notices the red LED turn solid red, DO NOT LET GO of the RESET button. While continuing to hold the RESET button in, remove power from the eWON. The eWON enter the Full Erase reset process.

### After a Reset

If the eWON gets reset (also called “full erase”), the settings will need to be reprogrammed. Contact MiTek Customer Service for assistance, and use the eWON configuration tool called *eBuddy* to define the eWON working IP address.

## Sensors

### Overview of Sensors

A complete list of sensors is found in Table 2-16. They are arranged in order of when they enter the workflow. Photos are shown on subsequent pages.

**Table 2-16: Overview of Sensors**

| Sensor Name                     | Description   | Refer to... |
|---------------------------------|---|-------------|
| Board Sensor (Load Arms)        | Indicates that lumber is located at a position where the load arms will raise it on the next up movement.   | page MT-195 |
| Load Arm Up                     | Indicates when the load arms are up so lumber feed system will not advance.   | page MT-195 |
| Load Arm Down                   | Indicates when the load arms are down so lumber feed system will advance.   | page MT-195 |
| Gripper Home                    | Determines the position of the gripper during the homing process.   | page MT-196 |
| Board Slip                      | Indicates if the board is tight against the gripper face.   | page MT-196 |
| Gripper Unclamped               | Indicates the gripper is not clamped.   | page MT-196 |
| Auto Deck Lumber Sensor         | Indicates there is a board present just behind the load arms by sensing the leading edge of the board. When the Auto Deck Lumber Sensor indicates a board is present, the system knows to index the board when the load arms clear of wood and are in the down position.                              | page MT-195 |
| Auto Deck Pusher Extend/Retract | Indicates the state of the lumber pusher on the Auto Deck (2 sensors).<br>Retracted=Home, Extended=Pushed   | page MT-195 |
| LASM Home                       | Determines the position of the LASM during the homing process.  | page MT-197 |
| LASM Lockout                    | Prevents saw blade from moving when LASM is within sensor's vision. Located on the stationary portion of the LASM assembly at the centerline of the saw blade. When LASM block is within the sensor's vision, the saw blade will not move because of a collision risk, unless overridden by software. | page MT-197 |
| LASM Fully Clamped              | Indicates that the LASM clamp is fully clamped, meaning there is no board present.  | page MT-197 |
| LASM Unclamped                  | Indicates when the LASM clamp is open.  | page MT-197 |

**Table 2-16: Overview of Sensors (Continued)**

| Sensor Name                      | Description   | Refer to... |
|----------------------------------|---|-------------|
| Bevel home                       | Determines the position of the bevel during the homing process and that the bevel is close to square.   | page MT-197 |
| Outfeed Fully Clamped            | Indicates when the outfeed clamp is fully clamped meaning there is no board present.  | page MT-197 |
| Outfeed Unclamped                | Indicates the outfeed clamp is open.  | page MT-197 |
| Crooked Lumber Sensor (CLS)      | Uses ultrasonic wavelengths to determine the location of the bottom of the board.   | page MT-197 |
| Leading Edge Receiver            | Works with the emitter sensor to determine the location of the leading edge of the board which is used in the board length measurement process. | page MT-199 |
| Leading Edge Emitter             | See Leading Edge Receiver description.  | page MT-199 |
| Side Clamp Fully Clamped         | Indicates when the side clamp is fully clamped meaning there is no board present.   | page MT-199 |
| Side Clamp Unclamped             | Indicates when the side clamp on the infeed side of saw is open.  | page MT-199 |
| Top Clamp Clamped (EP/TC Bottom) | Indicates when the top clamp is fully clamped meaning there is no board present.  | page MT-199 |
| Top Clamp Unclamped (EP/TC Top)  | Indicates when the top clamp on the infeed side of saw is up.   | page MT-199 |
| Top Clamp Ski Sensor             | Indicates the top clamp is clamped on a board.  | page MT-199 |
| Angle home                       | Determines the position of the angle during the homing process.   | page MT-199 |
| Stroke home                      | Determines the position of the stroke during the homing process and that the saw is in a retracted position.                                    | page MT-199 |
| Elevation home                   | Determines the position of the elevation during the homing process.   | page MT-199 |
| Saw Chamber Safety Switch        | Prevents saw chamber door from opening while blade is spinning.   | page OP-113 |
| Stroke Chamber Safety Switch     | Prevents stroke/elevation chamber door from opening while axes are moving.  | page OP-113 |

## Sensor Gaps for Prox Switches (Home Sensors)

The home sensors are all inductive proximity switches, also called *prox switches*. All prox switches should have an air gap between the sensor and the target of approximately 1/32”.

## Troubleshooting Home Sensors

*CLS troubleshooting can be found on page MT-192.*



### Checking Inspection Points

1. Check for obstructions interfering with the sensor.
2. Ensure all prox switches have 1/32” air gap.
3. Ensure dust and debris is not in the way of the sensor or target.

### Checking Communication Between the PLC and Sensor



Check the PLC input module to determine if the sensor is communicating with the PLC. The indicator light on the PLC should illuminate while the PLC is receiving data from the sensor.

### Resetting the System

Ensure “home” is correct by homing the axis or part in question. If “home” is not correct, the axis will hit a hard stop.



## Does the Home Sensor Have Power and Functionality?

1. For inductive proximity switches (Home sensors):
  - a) From the touch screen on the operator interface, select *Diagnostics>Detailed Diagnostics>* any servo tab.

|  |  |
|--|--|
|  |  <b>CAUTION</b>   |
| <br> | <p><b>CRUSH OR CUT HAZARD!</b></p> <p><b>Use extreme caution and effective communication when a second person is in the restricted zone.</b></p> |

- b) With one person watching the screen, have a second person place a screwdriver or anything with a steel or iron surface in front of the sensor.
    - 1) If the sensor has an LED light, it should illuminate when the metal object is detected. If the light does not illuminate, there is either no power to the sensor or the sensor is broken. Check the wiring and points of power farther up the line to determine where power transmission ends.
    - 2) On the *Detailed Diagnostics* screen, the indicator next to the Home Sensor field should turn blue while the metal object is detected. If it does not, there is a communication issue.
2. For other sensors (not inductive proximity switches):

- a) From the touch screen on the operator interface, select *Diagnostics>Detailed Diagnostics>* any servo tab.

|  |  |
|--|--|
|  |  <b>CAUTION</b>   |
| <br> | <p><b>CRUSH OR CUT HAZARD!</b></p> <p><b>Use extreme caution and effective communication when a second person is in the restricted zone.</b></p> |



- b) With one person watching the screen, have a second person watch the sensor while the operator manipulates the saw so the sensor engages.

If the sensor has an LED light, it should illuminate when the sensor engages. If the light does not illuminate, there is either no power to the sensor or the sensor is broken. Check the wiring and points of power farther up the line to determine where the power transmission ends.

3. Find the source of the problem and resolve:
  - a) Try substituting the cable that plugs into the junction box.
  - b) Try substituting the sensor with a sensor from spare parts, or a different sensor on the saw, but only if they are identical sensors.

## Adjusting & Troubleshooting the Crooked Lumber Sensor

The following instructions should be followed when:

- Parts are not accurate and the cause may be the elevation of the blade, OR
- The message *Out of Range* consistently displays in the CLS status menu (on the Home Screen Toolbar).



Straight 2x4x8  
or longer  
Plumb bob  
Round bubble  
level

### CLS Positioning

Figure 2-104: CLS

1. Move the LASM away from the CLS using the indicator menu on the Home Screen.
2. Remove top plate from CLS by removing the two screws on top of the CLS housing.
3. Calibrate the CLS.
  - a) Go to *Tools>Calibrate* from the operator interface.
  - b) Follow the on-screen instructions and select *Make Alignment Cut*.
4. Lockout/tagout.
5. Drop a plumb bob over the board and down just above the bubble level. Make sure the string from the plumb bob is in the newly cut slot in the board.
6. The sensor must be positioned so that it is centered on the blade, bubble level, and the board. Use the bubble level and plumb bob as devices to achieve positioning of the CLS. Figure 2-104 shows the adjustment screws on the CLS.



## Determine if CLS is Working



Straight 2x4x8  
or longer

1. Move the LASM away from the CLS so it doesn't interfere with the test.
2. Place a straight 2x4x8 or longer on the Infeed Rail and slide it into the saw chamber.
3. Unclamp and clamp the infeed and outfeed clamp (using indicator menus on Home Screen) so the board is firmly clamped in both.
4. Go to *Diagnostics>Detailed Diagnostics>CLS* tab.
5. Note the exact reading in the field circled in Figure 2-105.
6. Press the ACTIVATE button next to *Calibrate*. If the CLS is operating and adjusted correctly, the following should be true:
  - a) The field labeled *Current Reading* in Figure 2-105 should change by .02 or less.
  - b) The field labeled *Current Reading* in Figure 2-105 should be near 0.

**Figure 2-105: Diagnostics>Detailed Diagnostics>CLS Screen**

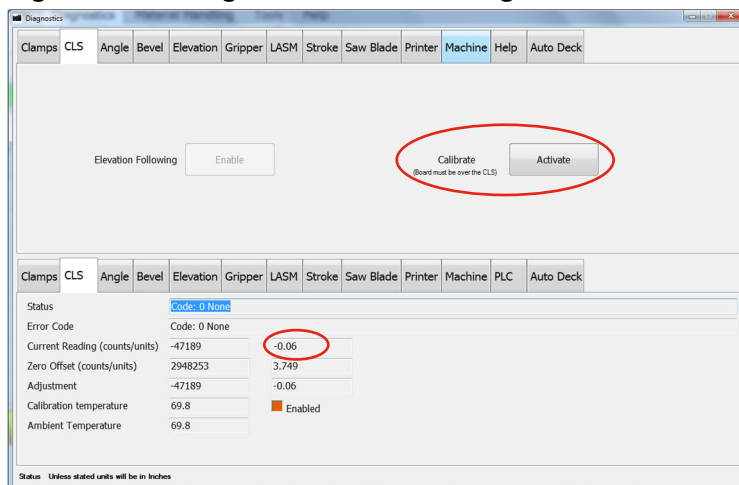

A working CLS makes a constant clicking sound.

### Testing the Elevation and CLS Communication



Straight 2x4x6  
or longer

1. Place a 2x4x6 or longer on the Infeed Rail and slide it into the saw chamber while still holding onto the end sticking out of the saw chamber. Ensure it is covering the CLS.
2. From the saw's operator interface, go to *Diagnostics>Detailed Diagnostics>CLS* and click the ENABLE button under *Elevation Following*.
3. Test the following steps and results:
  - a) Lift the infeed end of the lumber. It should result in the blade elevation rising.
  - b) Set the lumber down in its original position. It should result in the blade elevation lowering.
  - c) The elevation status menu (on the Home Screen indicators) should display *Enabled Homed*.
4. If the blade elevation moved as expected:
  - a) Wait for the blade elevation to settle (should not take more than 15 seconds). Once settled, monitor the blade elevation for 10 minutes.
  - b) During this period there should be no movement of the blade elevation. If there is movement, then remove the wire connection (unscrew the metal ring on the end of the cable at the sensor) from the bottom of the sensor. Using high-quality, dry compressed air, blow out the connector on the wire and on the sensor. Replace the wire on the sensor and repeat the test. If the test continues to fail contact technical support.

Figure 2-106: Sensors on Auto Deck and Infeed Rail

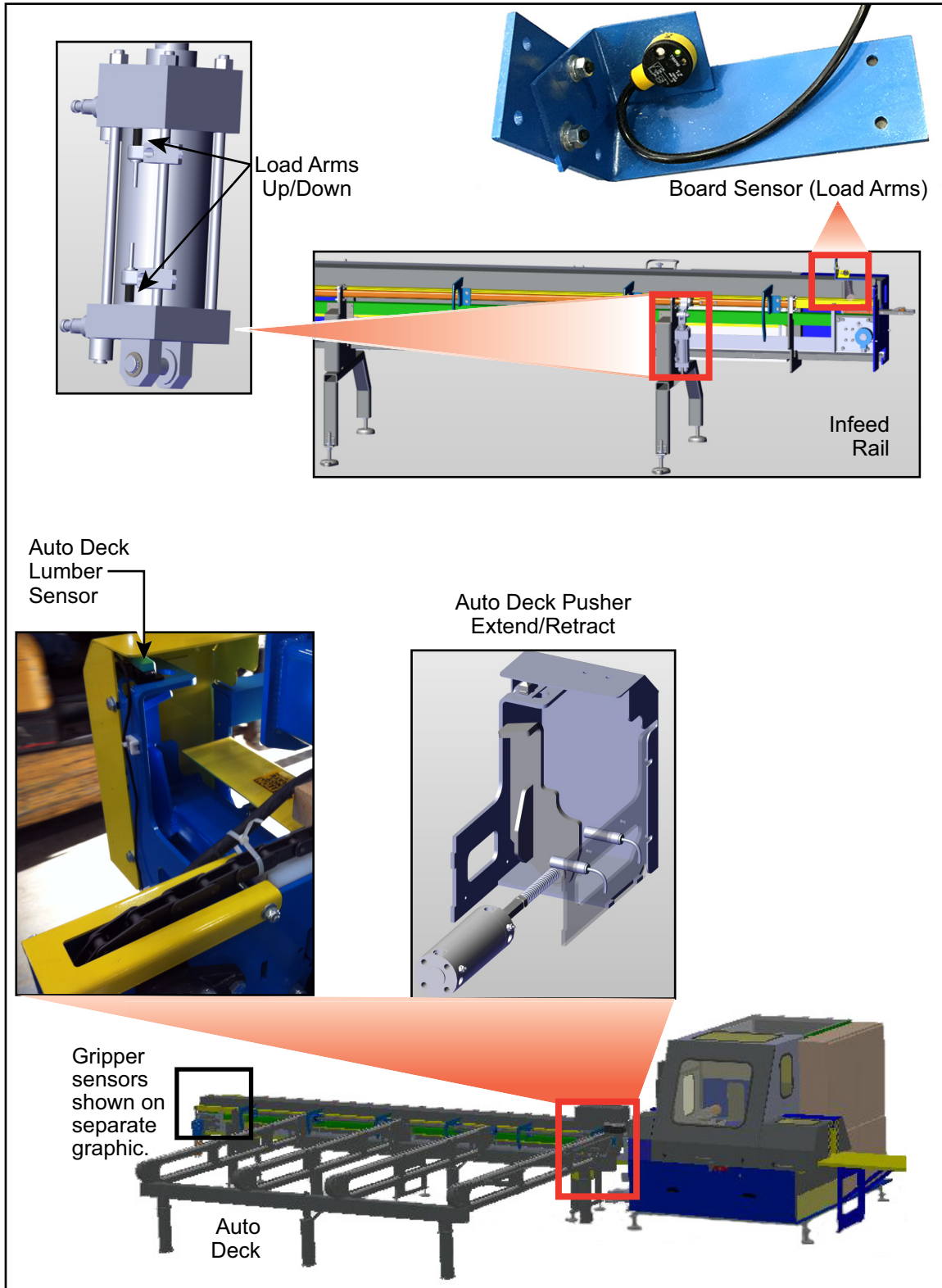

**Figure 2-107: Sensors on Gripper**

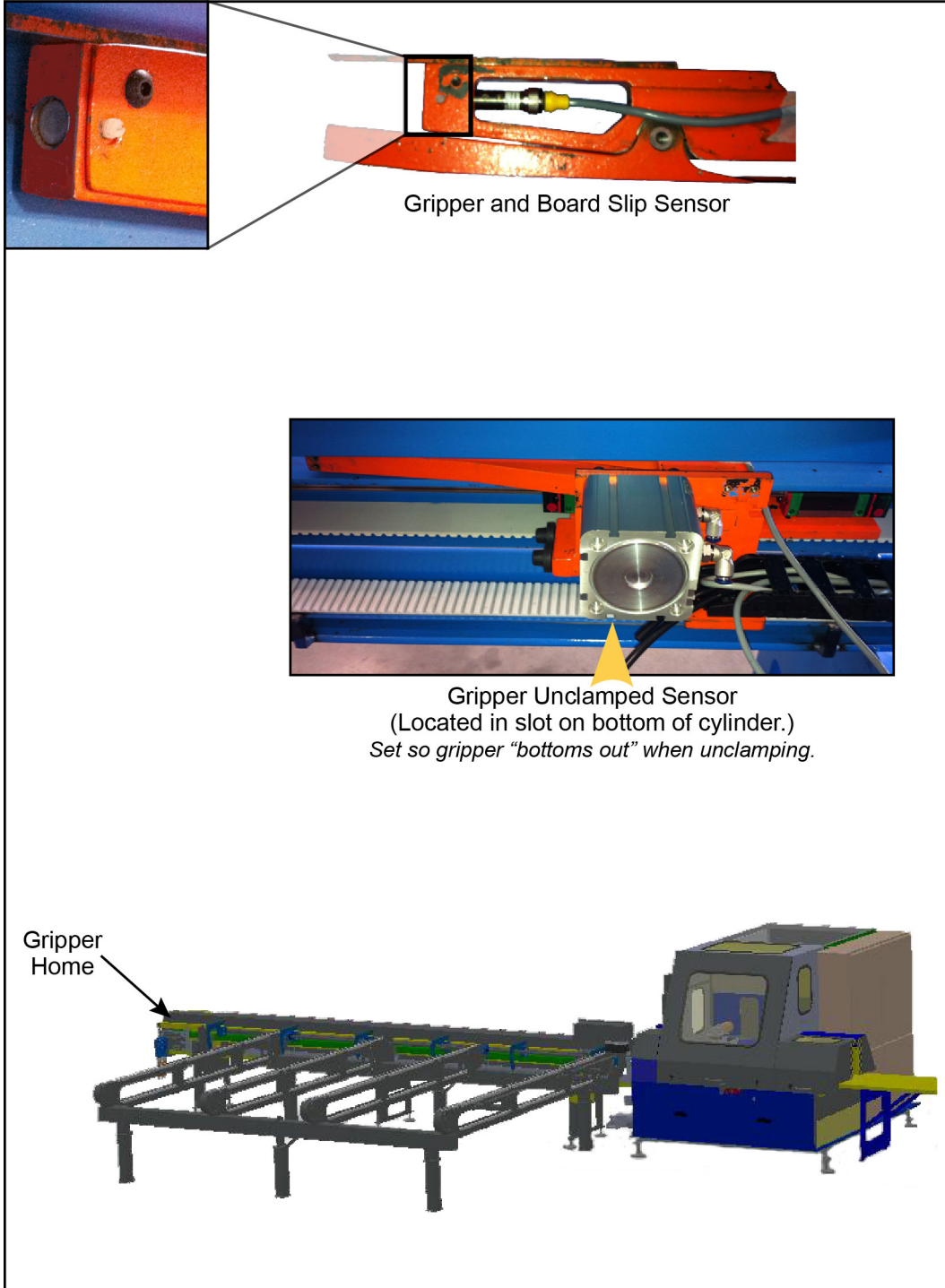

**Figure 2-108: Sensors on Front Side**

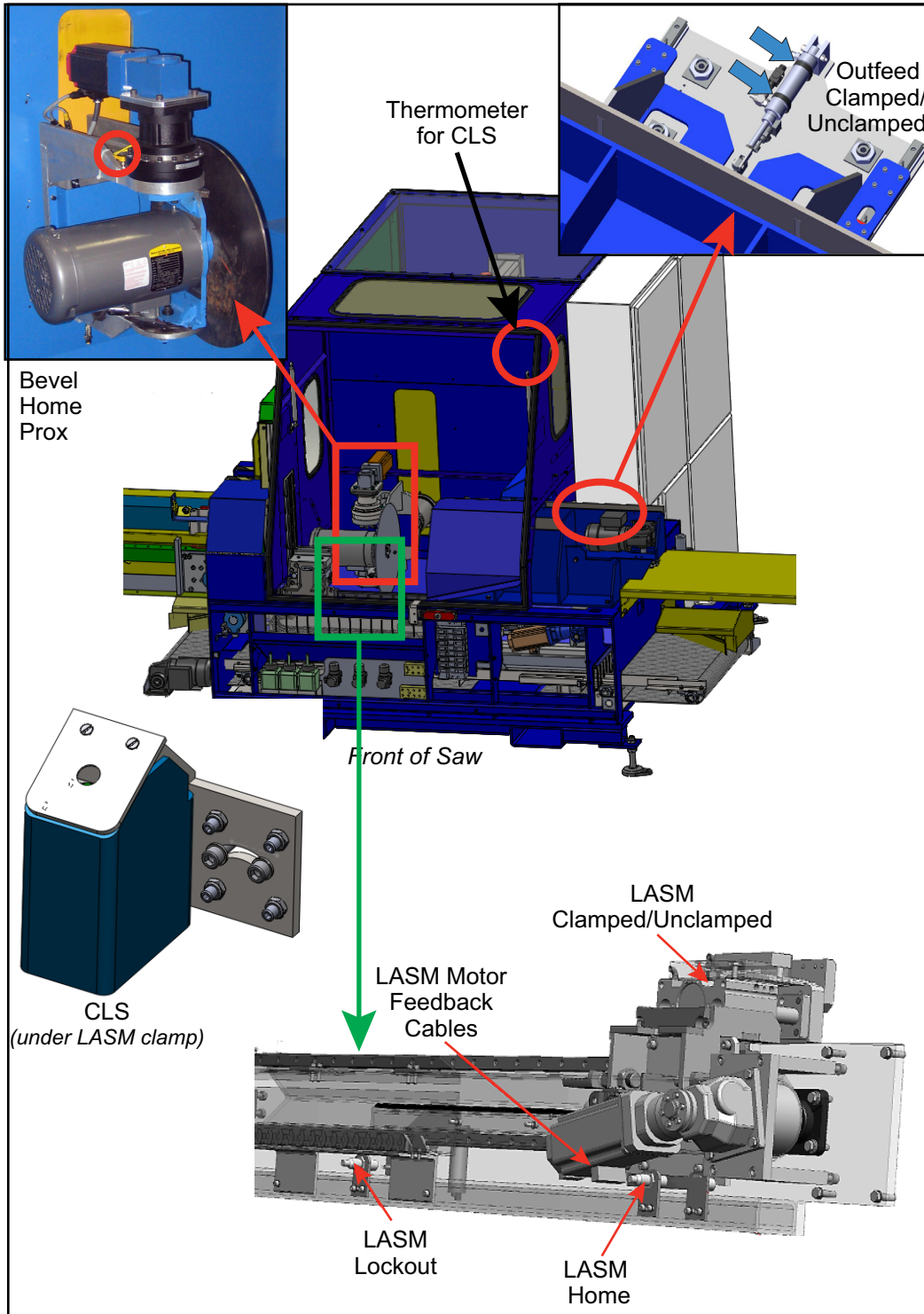



**Figure 2-109: LASM Clamp/Unclamp Sensors (Extend/Retract)**

*Concept shown here can be applied to all extend/retract sensors, but measurements can not.*

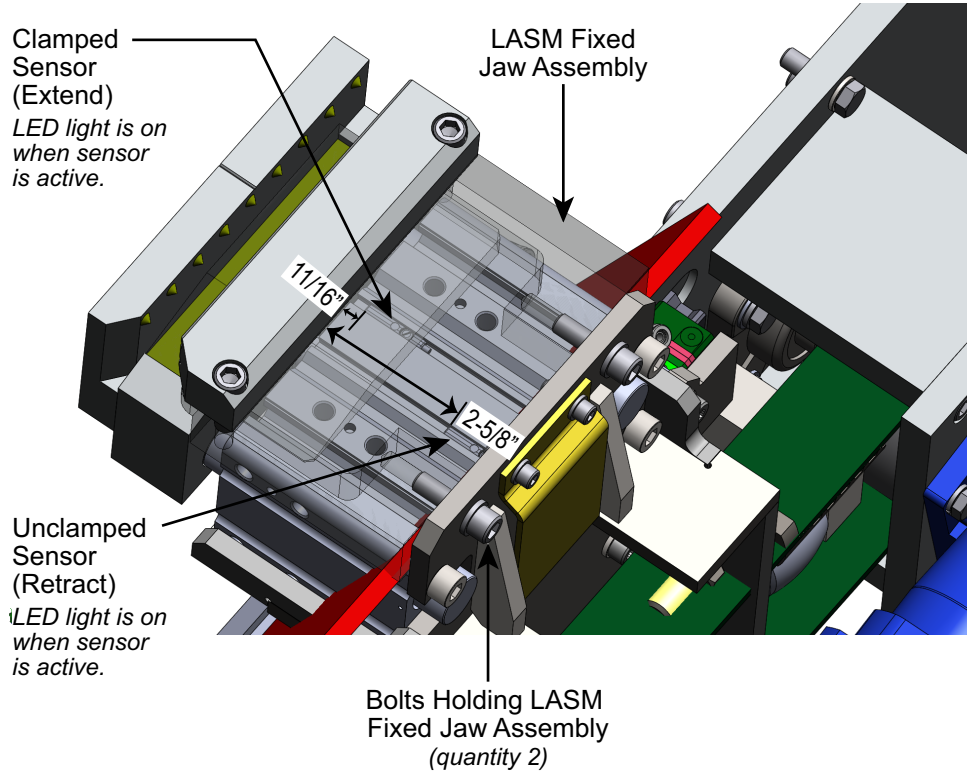



**Figure 2-110: Sensors in Stroke/Elevation Chamber & Infeed Side of Saw**

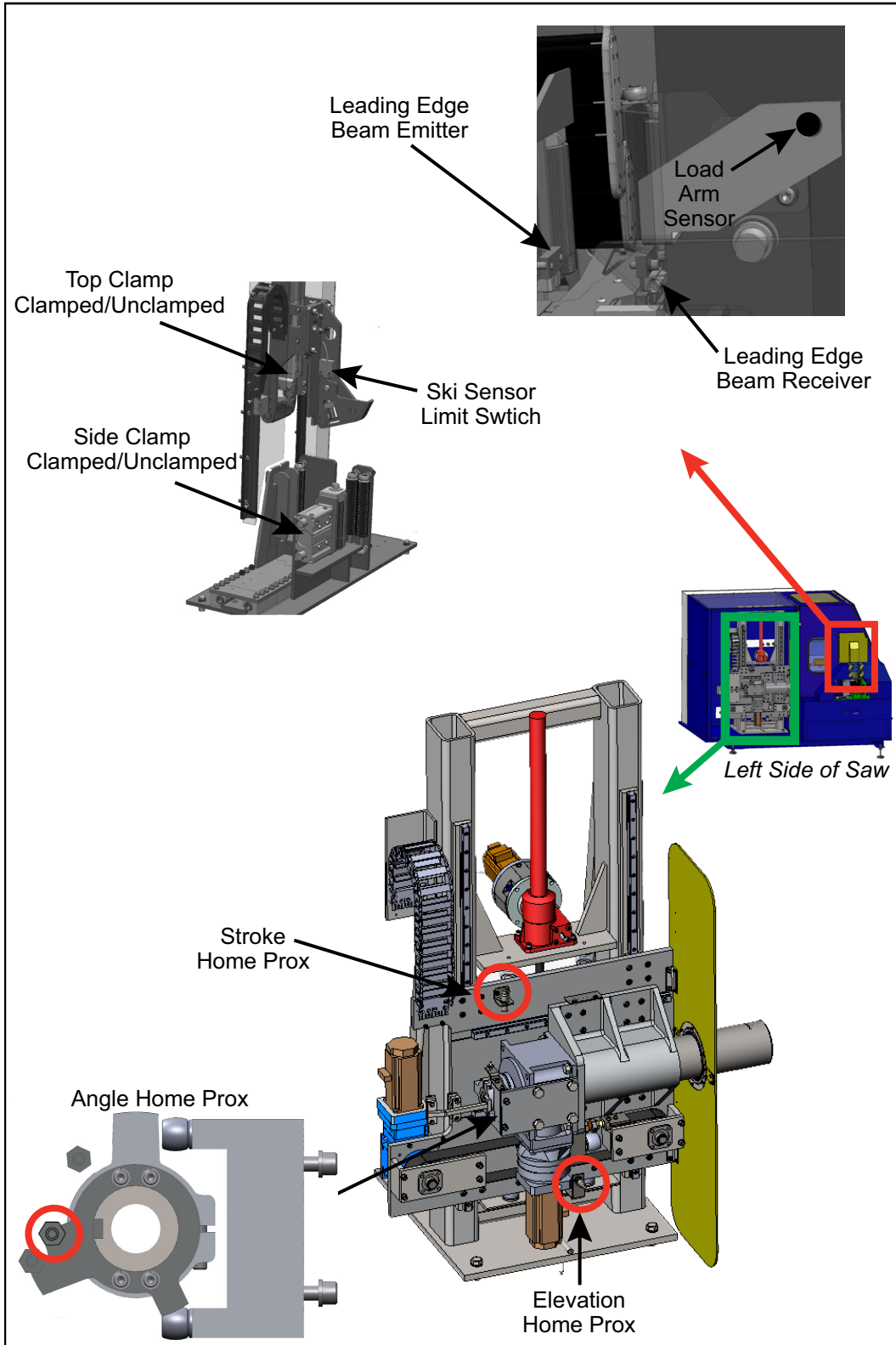

### Navigating the Troubleshooting Appendix



**Refer to...**

*Maintenance* chapter for procedures and graphics

page OP-71 for truss terminology

*Glossary* for additional terminology

page 54 to contact MiTek Machinery Division Customer Service

This appendix is divided into tables according to the system or components that are showing troublesome symptoms. The tables are presented in the order listed here.



Be sure to read the safety and training sections beginning on page MT-202 prior to performing any troubleshooting on the equipment.

| Trouble Topic                               | Page        |
|---|-------------|
| Saw, Printer, Infeed Rail Troubleshooting   | page MT-205 |
| Material Handling/Auto Deck Troubleshooting | page MT-214 |
| Software Errors                             | page MT-216 |
| Indicators on Specific Electronic Devices   | page MT-225 |
| Axis Identification                         | page MT-227 |

If you continue to have problems after performing all applicable troubleshooting steps and reviewing the topic in the *Maintenance* chapter, call MiTek Machinery Division Customer Service for assistance.

## Safety Notes for Troubleshooting

### General Troubleshooting Safety Tips

|   |  |
|---|--|
|  | <p style="text-align: center;"> <b>WARNING</b></p> <p><b>ELECTROCUTION, HIGH PRESSURE, CRUSH, CUT, AND CHEMICAL HAZARDS!</b></p> <p>Read all notes in this section <b>AND</b> the safety section in the preliminary pages before operating or maintaining this equipment.</p> <p>Most solutions are described in more detail in the <i>Maintenance</i> chapter and may have more safety notes included there.</p> |
|---|--|



- **Read all warnings** located in the safety section in the preliminary pages and adhere to them at all times.
- **When the graphic at the left appears, lockout/tagout at the disconnect switch located on the equipment** using approved methods described in OSHA 29 CFR 1910.147 before continuing with the procedure or troubleshooting.
- If the lockout/tagout graphic does not appear, it is recommended that you still **de-energize the machine** unless energy is required for the troubleshooting process. If it is absolutely necessary to troubleshoot an energized machine, follow NFPA 70E for proper procedures and personal protective equipment.
- **All electrical work must be performed by a licensed electrician.**
- **Read this manual** for information and procedures related to the specific maintenance or troubleshooting issue before attempting any maintenance!
- **Safety goggles and a dust mask** must be worn for all cleaning steps outlined in this manual. When using cleaning and lubrication solutions, a respirator rated for use with those solutions must be worn as well as gloves resistant to the solution.

## Electrical Troubleshooting Safety Tips

- **Make sure you have the proper tools needed for the job.** See *Tools Needed* on page 203.
- **Ensure the person performing the troubleshooting is qualified** from an electrical knowledge standpoint. If you feel uncertain about troubleshooting electrical power, remember that the cost of hiring an electrician far outweighs the cost of an injury.
- **Remove rings and watches that you are wearing.** They are extremely conductive material and may catch on small components.
- **Get a helper.** You are most likely going to need a third hand at some point, and you shouldn't perform electrical work without someone close by to help if you get hurt.
- **Be patient.** Take your time and stay alert. Never shortcut or become too confident in what you are doing; electrical power will always be stronger than you.
- **Take notes** recording what you have checked, and what the readings were. This is also a good way to check your work when you are finished. Sometimes, the machine won't work because a wire was removed for testing, and overlooked when cleaning up. Having proper notes will make the process go much more smoothly.
- **ALWAYS turn the power off** if you are checking for ohms or swapping PLC cards.
- **ALWAYS push an E-stop button** before approaching a machine for any reason, but if you are working with the encoders it is especially important. An interruption to a powered encoder may cause components to move without warning.
- **Wear appropriate personal protective equipment (PPE)** for working with live power.

## Getting Started With Troubleshooting

### Tools Needed



Gather these tools before beginning the troubleshooting process and before calling MiTek for technical assistance.

1. Slotted screwdriver, insulated
2. Phillips screwdriver, insulated
3. Equipment manual and drawings, specifically electrical schematics
4. Pen and paper to take notes and document settings
5. Multimeter

A multimeter is an electronic measuring instrument. The analog versions were referred to as an analog volt-ohm-meter (VOM). A newer, digital model is called a digital-multi-meter (DMM). There are a large variety of volt-measuring devices available, but at a minimum, it should have these features:

- Voltage (volts) measurement
  - Resistance (ohms) measurement
  - Ability to measure both AC and DC power
  - Autoranging feature
  - It is highly beneficial to also have the ability to measure current (amps)
6. Various additional tools depending on specific parts needing repair
  7. Personal protective equipment as dictated by NFPA 70e

### Phase 1 Troubleshooting Steps

#### For Mechanical Troubleshooting



Always clean and lubricate the equipment as a first step in most troubleshooting processes. Most mechanical malfunctions are caused by inadequate preventive maintenance.

Look for barriers such as jammed wedges, parts rubbing, etc.

## For Electrical Troubleshooting



1. Lockout/tagout at the disconnect switch located on the equipment.

|   |   |
|---|---|
|  | <p><b>Never use compressed air inside the electrical enclosures! It may force contaminants into the electrical connections.</b></p> <p><b>Use a vacuum to remove dust from electrical enclosures. Canned air is acceptable after vacuuming.</b></p> |
|---|---|

2. Vacuum and dust the electrical enclosure.
3. Remove the lockout/tagout equipment and attempt to run the machine again. If that didn't fix the problem, proceed with the next step.
4. Adhere to all regulations and guidelines given in NFPA 70e and in your company's energy control program. Some important safety tips are also addressed on page 202.

|  |   |
|--|---|
|  | <p style="text-align: center;"><b>⚠ WARNING</b></p> <p><b>ELECTROCUTION HAZARD!</b></p> <p><b>All electrical work must be performed by a licensed electrician.</b></p> <p><b>If it is absolutely necessary to troubleshoot an energized machine, follow appropriate guidelines.</b></p> |
|--|---|

5. Look for a tripped overload if it applies.
6. Determine where the electrical problem begins. To do this, you need a multimeter. If you are unfamiliar with your multimeter, consult the manufacturer's manual.
  - Determine if you are working with AC (alternating current) or DC (direct current) before checking for voltage. Your multimeter should measure both, but you'll have to tell it which one to measure.
  - Measure incoming and outgoing voltage to specific components. Proceed along a logical order determined by your machine's specific problem, and write down the order that you check each item and the amount of voltage that it registers.



**Should you lockout/tagout to safely perform this action?**



## Symptoms and Solutions

### Saw, Printer, Infeed Rail

Table A-1: Saw, Printer, Infeed Rail Troubleshooting

| Problem Category or Part | Problem  | Possible Cause & Solution  | See Page |
|--------------------------|--|--|----------|
| Air                      | My saw keeps shutting off saying that I don't have enough air pressure.  | Make sure that you have followed the pneumatic guidelines in the <i>Prior to Installation</i> chapter.   | IN-28    |
|                          |  | <p>Ensure the main regulator is set correctly and the saw is consistently receiving between 75-110 psi.</p> <p>The pressure switch should be set to 75 psi. It can be adjusted, but never operate the saw with less than 75 psi.</p> <p>Replace pressure switch, regulator, or seals in filter/regulator assembly.</p> | MT-137   |
| Amp                      | <p>My condition matches all of the following:</p> <p>A servo amplifier has the ALM LED on.</p> <p>A servo has a <i>Low voltage on DC Link</i> error on the PC.</p> <p>The <i>Caution High Voltage</i> red LED in the upper left of an amplifier is not on when others are.</p> | Pull out the FU10 fuse, wait 10 seconds, and push in. The FU10 fuse is a terminal block fuse in the top half of the main electrical enclosure.   |          |
| Amp                      | <p>My condition matches all of the following:</p> <p>ALL servo amplifiers have the ALM LED on.</p> <p>One or more servos have a <i>Low voltage on DC Link</i> error on PC.</p> <p>The <i>Caution High Voltage</i> red LED in the upper left of the amplifiers is not on.</p>   | Three phase power to the contactors above the amplifiers is missing. Check 3-phase connections and FU9 fuses for continuity. Fuse 9 is on the top row of fuses in the main electrical enclosure.   |          |





**Should you lockout/tagout to safely perform this action?**



**Table A-1: Saw, Printer, Infeed Rail Troubleshooting (Continued)**

| Problem Category or Part | Problem  | Possible Cause & Solution  | See Page                                 |
|--------------------------|--|--|--|
| All                      | An axis is not moving  | <p>Blow off the equipment (not inside electrical enclosures).</p> <p>Look for mechanical barriers such as wedges, fallen tools, parts rubbing or blocking each other.</p> <p>Lubricate the areas in question as directed in this manual.</p> <p>Check for a tripped overload.</p> <p>Check servo amplifiers in main enclosure: check for power (red LED), cable connections, power supply,</p>                             | <p>MT-72</p> <p>MT-164</p> <p>MT-144</p> |
| All                      | Sensor is not working or component controlled by a sensor is not responding properly   | Refer to page MT-203 for a systematic troubleshooting procedure.   | MT-203                                   |
| Angle                    | My straight cuts come out the correct length, but my angled parts are off.   | Run auto calibration on the angle and elevation.   | OP-160                                   |
| Board or Length Issue    | <p>No board was detected during the measuring process.</p> <p>Indicates the Leading Edge Detector Sensor didn't get activated.</p> | <p>Ensure the correct length was entered.</p> <p>Check that board is in gripper properly. Troubleshoot reasons why not.</p> <p>Calibrate gripper, and let saw measure again, checking that board is in gripper properly.</p> <p>Try adjusting the Leading Edge Sensor (emitter or receiver) in <i>Tools&gt;Options&gt;Saw&gt;Edge Detector Beam Sensor</i>. It measures from center of beam sensor to center of blade.</p> | <p>MT-108</p> <p>OP-160</p>              |
| Board or Length Issue    | <p>Board in the machine is too short.</p> <p>Indicates the Leading Edge Detector Sensor didn't get activated.</p>                  | <p>Measure board.</p> <p>Check that board is in gripper properly. Troubleshoot reasons why not.</p> <p>Calibrate gripper, and let saw measure again, checking that board is in gripper properly.</p> <p>Try adjusting the Leading Edge Sensor (emitter or receiver) in <i>Tools&gt;Options&gt;Saw&gt;Edge Detector Beam Sensor</i>. It measures from center of beam sensor to center of blade.</p>                         | <p>MT-108</p> <p>OP-160</p>              |

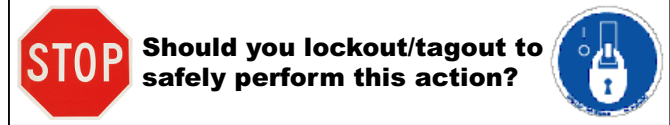

**Table A-1: Saw, Printer, Infeed Rail Troubleshooting (Continued)**

| Problem Category or Part | Problem   | Possible Cause & Solution   | See Page                   |
|--------------------------|---|---|----------------------------|
| Board or Length Issue    | My screen says that the stock lumber is too short, but I measure the lumber and it is the correct length.                                       | Check the gripper home position by running auto-calibration.  | OP-160                     |
|                          |   | <ol style="list-style-type: none"> <li>1. Before the next board is run during a job, measure and record the length of the next board to be cut.</li> <li>2. Calibrate the Gripper home position and re-cut the "board" using a new piece of lumber. If the problem is not resolved...</li> <li>3. Make sure that the <i>Actual Length</i> field corresponds with measured length. If the numbers don't correspond, change the Edge Detector Photo Eye value in <i>Tools&gt;Options&gt;Saw</i> by the amount the board measures off.</li> <li>4. If the board measures short, decrease the measurement for the sensor position.</li> </ol> | OP-160                     |
| Board or Length Issue    | My straight cuts come out the correct length, but my angled parts are off. The actual angle is not what the screen is telling me I should have. | Cut a type 2 part with a 45 degree angle from the Key In Parts screen. Adjust the elevation up if short by amount that you are short and vice versa.  | OP-89                      |
|                          |   | Check the angle calibration and recalibrate if necessary.   | OP-160                     |
| Board or Length Issue    | The last part of my board is always short but the blade was making a trailing cut   | The air pressure should be the same as line pressure. Check that the regulator is set correctly and the saw is receiving approximately 100-110 psi.   | MT-134                     |
|                          |   | Replace the LASM teeth if showing wear.   | MT-113                     |
|                          |   | Check the LASM inches per count through auto-calibration  | OP-160                     |
| Board or Length Issue    | The length for the last part on my board is wrong.  | Check the last part on the board. There should be a mark from where the gripper clamped onto the board if the end of the board was cut square. If there is any indication of the board slipping (Ex. A long scrape mark), the gripper clamp pressure may need to be increased.  | MT-108<br>MT-109<br>MT-134 |
|                          |   | The gripper home position is incorrect. Auto-calibrate the gripper.   | OP-160                     |
| Board or Length Issue    | I am getting random lengths off by 1/8" up to 1"  | Verify the gripper and LASM home positions and inches per count by running auto-calibration.  | OP-160                     |
|                          |   | The gripper or LASM may be slipping. Check that the regulator is set correctly.   | MT-134<br>MT-137           |
|                          |   | Replace the LASM teeth if showing wear.   | MT-113                     |



**Table A-1: Saw, Printer, Infeed Rail Troubleshooting (Continued)**

| Problem Category or Part   | Problem  | Possible Cause & Solution   | See Page |
|--|--|---|----------|
| Clamps   | Infeed side or top clamp is not working.                                 | Check for obstructions.   | MT-134   |
|  |  | Check system pressure (main regulator) and secondary regulator for clamp to ensure correct air pressure.  |          |
|  |  | Check the shock absorber and tighten or replace as needed.  | MT-103   |
|  |  | Determine if coils are working by checking LEDs on coils as you clamp and unclamp.  | MT-89    |
|  |  | Fully Clamped Sensor may be activated too early if not positioned correctly. Reposition the sensor.   |          |
| Linear guide bearings may not be properly working. Check lubrication and physical condition of bearing block and rails. Replace bearing block if uncertain of age. |  |   |          |
| Collision  | Getting frequent messages that saw blade will contact LASM in Auto Mode. | Check that the LASM <i>Max Position</i> is set to 12 inches (305 mm) or higher.<br>Check that LASM is aligned properly: Notch in center of LASM should align with saw blade when LASM is at 0 position. |          |
| Cuts   | Getting inconsistently inaccurate cuts                                   | Ensure Infeed Rail finger is in the same plane (straight with) the LASM fixed jaw for the Infeed Rail's entire length.<br>CLS is not working; bowed lumber is inaccurately cut.                         |          |
| E-Stop   | Pull cord activates itself or will not reset                             | Blow dust out of sensor with canned air and check cable connections.<br>Check alignment (centering) of pull-cord switch.  | MT-143   |
| eWON   | The eWON red User light is a solid red.                                  | All communications data on the eWON has been reset because the RESET button was held in for more than 4 seconds.  | MT-186   |
| Gripper  | My parts are off roughly 3/8 of an inch consistently.                    | The belt has jumped a cog on the pulley. Calibrate the gripper.   | OP-160   |
|  |  | The white gripper timing belt may be set too loose. Re-tension the belt.  | MT-85    |
| Gripper  | The gripper is hitting an obstruction when none can be seen.             | Ensure the gripper is not hitting the infeed side clamp.  | MT-134   |
|  |  | The air pressure on the infeed roller might be set too high. Verify it is at the recommended setting.   |          |
|  |  | If none of the above steps help, then manually move the gripper to find tight spots in the belt.  | MT-108   |



**Should you lockout/tagout to safely perform this action?**



**Table A-1: Saw, Printer, Infeed Rail Troubleshooting (Continued)**

| Problem Category or Part | Problem   | Possible Cause & Solution  | See Page                              |
|--------------------------|---|--|---------------------------------------|
| Gripper                  | When the gripper goes back to accept the maximum length board the gripper jams. (Or the wood lands on top of the gripper assembly.) | Check the gripper home position, counts per inch, and maximum position by running auto-calibration.  | OP-160                                |
| Gripper                  | Gripper won't move manually.  | Check error state of gripper.<br>Move it using the touch screen in Manual Mode.<br>Wood may be bowed.  |                                       |
| Gripper                  | Gripper won't move.   | Try to move it manually. If it doesn't move check the Status Indicator on the Toolbar for clues.<br>Check for obstructions or mechanical binding.<br>Blow off the Infeed Rail.<br>Linear guide bearings may not be properly working. Check lubrication and physical condition of bearing block and rails. Replace bearing block if uncertain of age.   | MT-89                                 |
| Gripper                  | Gripper Home sensor air gap is too big.<br>Receiving home Z pulse errors.   | Check the tension of the white gripper timing belt, and ensure the gripper motor coupling is not loose.<br><br>If problem still exists, calibrate gripper.<br><br>If needed:<br><ol style="list-style-type: none"> <li>1. Remove the white gripper timing belt.</li> <li>2. Check linear bearings to ensure the entire assembly is not sagging.</li> <li>3. Remove the screws holding the gripper to the bearings.</li> <li>4. Add thread adhesive (<i>Loctite</i>) and install the screws back in place.</li> <li>5. Adjust gripper home sensor air gap to 1/32".</li> <li>6. Calibrate gripper again.</li> </ol> | MT-84<br>MT-81<br>MT-78<br><br>OP-160 |

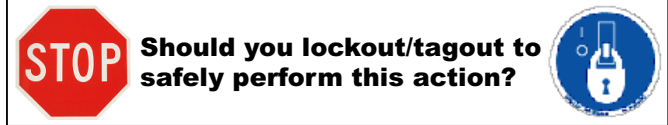

**Table A-1: Saw, Printer, Infeed Rail Troubleshooting (Continued)**

| Problem Category or Part | Problem  | Possible Cause & Solution  | See Page                                  |
|--------------------------|--|--|---|
| Gripper                  | The board is not against the gripper face.                                       | <p>May occasionally occur and is no need for alarm.</p> <p>If happening often or consistently with a certain length, calibrate gripper.</p> <p>If still happening, check that gripper is physically retracting far enough. If not, adjust it in <i>Tools&gt;Options&gt;Clearance to Accept Stock</i>.</p> <p>Gripper is not clamping tightly:</p> <ol style="list-style-type: none"> <li>1. Check the air pressure.</li> <li>2. Check tightness of gripper assembly parts.</li> </ol>        | <p>OP-160</p> <p>MT-134</p> <p>MT-109</p> |
| LASM                     | Saw blade cut through the LASM jaw.  | Call Customer Service for further instructions before restarting anything.   | MT-54                                     |
| LASM                     | LASM unclamp timing out.   | Check position of the extend and retract sensor. Tighten all bolts.  | MT-198                                    |
| Lumber Feeding           | Lumber clips the saw entrance ramp   | Infeed Rail lumber surface is below the entrance ramp. Level the Infeed Rail to the saw.   |   |
| Lumber Feeding           | Lumber not entering saw chamber straight.  | Ensure Infeed Rail finger is in the same plane (straight with) the LASM fixed jaw for the Infeed Rail's entire length.   |   |
| Lumber Feeding           | Lumber catching on load arms and not feeding onto Infeed Rail correctly.         | Tighten the Auto Deck chain tension.   | MT-107                                    |
| Motors (Servo)           | Abnormally high motor current. To reset this error the saw power must be cycled. | <p>Check for obstructions</p> <p>Check the servo power (PWR) cable. Re-check all servo connections to ensure both screws are on and that the connector is not loose at install.</p> <p>Check the cable: If the encoder cable is not connected to the servo motor, the LED light on the amplifier will not be on.</p> <p>On angle axis, can use the spare servo motor in the spare parts kit until the replacement is sent. The angle axis is the only servo motor with an internal brake</p> |   |
| Op Interface             | Button or field is grayed out  | <p>Check that the Auto/Manual switch is in the correct position.</p> <p>Read the status banner on the touch screen for clues to the saw's status. If the solution is not clear from the status banner text, perform the procedure on the page indicated here.</p>  | OP-133                                    |



**Table A-1: Saw, Printer, Infeed Rail Troubleshooting (Continued)**

| Problem Category or Part | Problem   | Possible Cause & Solution   | See Page |
|--------------------------|---|---|----------|
| Op Interface             | Some indicators are red                             | Click on red indicator and notice if bottom menu item says Enabled Not Homed or Enabled Homed. After homing the system, it should say Enabled Homed. If not, investigate obstructions, lubrication, and other mechanical reasons.<br><br>Click CLEAR ERRORS on Toolbar.<br><br>Click HOME SYSTEM on Toolbar.  |          |
| Op Interface             | Visualize screen is not working.                    | Open <i>Diagnostics</i> > <i>Visualize</i> screen prior to pressing the START CUTTING button.   |          |
| Op Interface             | Lumber is not feeding after pressing START CUTTING. | Check to see if START CUTTING button has yellow banner reading AIR CUT across it. If so, go to <i>Diagnostics</i> menu and remove the check mark next to <i>Air Cut</i> .<br><br>Check for Auto Deck errors, specifically if Load Arm Lumber sensor is detecting board.   | MT-195   |
| Op Interface             | Keyboard needed to startup or logon.                | Certain customer profiles could require a keyboard to use the saw's operator interface. The solution is explained on the page listed here.  | MT-185   |
| Op Interface             | Saw is in <i>Waiting for Printer Trigger</i> state. | Select <i>Abort Cutting Sequence</i> on the <i>Diagnostics</i> ribbon. Do NOT adjust trigger status in <i>Detailed Diagnostics</i> —it will cause the printing sequence to be out of order.   |          |
| Outfeed                  | Outfeed chain is binding.                           | Look for broken bolts or plastic obstructing the chain.<br><br>Check chain tension.   | MT-117   |
| Outfeed                  | I am getting an outfeed timeout failure.            | Short Wedges may be stuck between the two outfeed rollers. Remove and retry.<br><br>Adjust the outfeed clamping roller sensor.<br><br>Align and/or tighten the lumber exit chain.<br><br>If the problem persists, the following tips will help further troubleshooting:<br><br>1. When a board is clamped, the lights on both sensors (extend and retract) should be off.<br><br>2. When the clamping rollers are at full extend (without wood), the light on the extend sensor should be on.<br><br>3. When the clamping rollers are fully retracted only the retract sensor light should be on. |          |
| Powered Skewed Conveyor  | Rollers are slow to reach full speed                | Tighten belt tension  | MT-130   |



**Table A-1: Saw, Printer, Infeed Rail Troubleshooting (Continued)**

| Problem Category or Part | Problem  | Possible Cause & Solution  | See Page                   |
|--------------------------|--|--|----------------------------|
| Printer                  | Cutting sequence is out of order.  | May happen if the printer trigger state is changed in <i>Detailed Diagnostics</i> . For now, abort cutting sequence and start the job over at the right place. To prevent in future: When you receive the saw status <i>Waiting for Printer Trigger</i> , use the <i>Abort Cutting Sequence</i> button on <i>Diagnostics</i> ribbon.         |                            |
| Remote Help              | Java exception error when trying to run Talk2M (remote help)                         | Upgrade Java to latest version.<br>Determine if 32-bit or 64-bit software is needed. Check both at the following web address:<br><a href="http://wiki.ewon.biz/Support/06_Knowledge_Base/Questions_and_Answers/Talk2M_connection_checker">http://wiki.ewon.biz/Support/06_Knowledge_Base/Questions_and_Answers/Talk2M_connection_checker</a> |                            |
| Safety                   | Safety motion sensor channels are not both lighting up.                              | Inspect blade motor cable for physical damage.<br>Complete safety motion sensor setup procedure given on the page indicated.   | MT-157                     |
| Saw                      | The PC is having trouble communicating with the saw (PLC).                           | Check power supply and cabling, including all connections.   |                            |
| Saw Head                 | Saw blade is unusually hot   | Replace with a sharp blade   | MT-97                      |
| Sensor                   | CLS not working  | Check that the housing and bracket are in good condition to protect the CLS and keep it in place.<br>Check that the CLS cable is securely connected.<br>Check the CLS positioning.<br>Check that CLS is receiving power and sensor is working (check positioning first).<br>Check that the CLS and elevation are communicating.              | MT-192<br>MT-193<br>MT-194 |
| Sensor                   | Error: Loss of encoder   | Adjust the in/out adjustment bolts to prevent the encoder from making contact with the coupler.  |                            |
| Sensor                   | Sensor is not working or component controlled by a sensor is not responding properly | Refer to the systematic troubleshooting procedure.<br>Troubleshoot the Auto Deck sensors, specifically, ensure the Load Arm Lumber sensor is detecting the board.  |                            |
| Sensor                   | Component timing out.  | Check location of extend and retract sensors.  |                            |





**Should you lockout/tagout to safely perform this action?**



**Table A-1: Saw, Printer, Infeed Rail Troubleshooting (Continued)**

| Problem Category or Part | Problem  | Possible Cause & Solution   | See Page |
|--------------------------|--|---|----------|
| Stroke                   | Stroke error                                     | Calibrate.<br>Stroke travel may be bottoming out. Set minimum position to 1.25 in <i>Detailed Diagnostics</i> screen.   | OP-160   |
| User Interface           | Touch screen is responding unpredictably.        | May need to upload drivers again.<br>May need a firmware update.<br>Could be caused by a <i>Windows</i> update. May consider turning off <i>Windows Updates</i> in the Control Panel. |          |
| Waste Conveyor           | Waste conveyor not moving or not moving smoothly | Check for tripped overload.<br>Check around edges and ends of belt for wedges or debris.  | MT-164   |



**Should you lockout/tagout to safely perform this action?**



## Material Handling

**Table A-2: Material Handling/Auto Deck Troubleshooting**

|           | <b>Problem</b>   | <b>Possible Cause &amp; Solution</b>  | <b>See Page</b>            |
|-----------|--|---|----------------------------|
| Auto Deck | Auto Deck is running in the wrong direction.                         | Your motor is wired incorrectly.<br>Selector switch on Auto Deck operator interface panel is wrong.   |                            |
| Auto Deck | Auto Deck is not advancing the board correctly onto the load arms.   | Adjust the location of the Auto Deck Board sensor.  | MT-195 for sensor location |
| Auto Deck | Auto Deck load arms are not moving down far enough to accept lumber. | Adjust the entire square tube that holds the load arms by loosening the hex nut.  |                            |
| Auto Deck | Auto Deck is not running   | Check the Auto Deck's variable frequency drive (VFD) for errors. The VFD is located in the control panel on the Auto Deck. Check the wires from the motor to the VFD.       |                            |
| Auto Deck | More than 1 board is being loaded onto the Infeed Rail at a time.    | The Auto Deck may be overcrowded. Remove excess boards.<br>Adjust the Auto Deck Board sensor position.<br>Use the lumber stops to limit the number of boards being indexed. | MT-195<br>OP-157           |
| Auto Dec  | Getting error from Auto Deck VFD.                                    | Conveyor chain may be tensioned too tight.  | MT-107                     |



**Should you lockout/tagout to safely perform this action?**



## Printer

**Table A-3: Printer Troubleshooting**

|         | Problem   | Possible Cause & Solution   | See Page |
|---------|---|---|----------|
| Printer | No printout and no clicking sound heard from head during printout.                          | Select a message to print using <i>Board Stretcher</i> software. Ensure there is text (or graphic) in the message chosen. Refer to the <i>Board Stretcher</i> manual. | OP-100   |
|         |   | Ensure the control unit's power switch is on and that it is on in the <i>BLADE</i> software.  |          |
|         |   | Ensure print head cable is connected.   |          |
| Printer | No printout or poor printout quality but clicking sound is heard from head during printout. | Ensure hose from ink bottle is connected and ink bottle is full. Check hose for blockage.   | OP-181   |
|         |   | Ink pressure should be 0.4 - 0.8 bar.   |          |
|         |   | Dot size must be within acceptable range.   | OP-101   |
|         |   | Clean or replace ink filter.  |          |
| Printer | Print head won't print  | Check ink supply, clean nozzle, purge and flush, and check clogs in line.<br>Check gripper encoder and cable.   | OP-168   |
| Printer | My printing has a blank line through the middle of it. It's not printing properly           | Flush and clean the printers.   | OP-176   |
| Printer | The encoder LEDs stay lit even when the controller is powered down.                         | This is normal if the controller was powered down from the touch screen computer. It is not a problem.  |          |



## Software Errors

**Table A-4: Errors in Software**

| Error Code                    | Text on Screen   | Definition or Solution  |
|-------------------------------|--|---|
| AutoDeck Error002             | Board not on sensor  | Adjust the Auto Deck board sensor (for load arms) and check connections   |
| AutoDeck Error003             | Air cylinder out of position                                       | Indicates the Auto Deck pusher is not working. It may be caused by: <ul style="list-style-type: none"> <li>Damaged Auto Deck Pusher Extend/Retract sensor is damaged or location needs to be adjusted</li> <li>Mechanical obstruction</li> <li>Inspect for other reasons the pusher is not retracted when it should be</li> </ul> |
| AutoDeck Error004 or Error005 | Pusher home position (or pushed position) sensor not seen          | Indicates the Auto Deck Pusher Retract (for 004) or Extend (for 005) sensor is not working. It may be caused by: <ul style="list-style-type: none"> <li>Sensor is damaged or location needs to be adjusted</li> <li>Mechanical obstruction</li> <li>Inspect for other reasons the sensor may not be working</li> </ul>            |
| AutoDeck Error006 or Error007 | Pusher failed to move from home position (or from pushed position) | Pusher is not getting off the Auto Deck Pusher Retract (for 006) or Extend (for 007) sensor soon enough. It may be caused by: <ul style="list-style-type: none"> <li>Low air supply pressure</li> <li>Air valve coil is damaged</li> <li>Mechanical obstruction</li> </ul>  |
| AutoDeck Error008             | Invalid air cylinder sensor condition                              | Pusher is not on either the Auto Deck Pusher Retract nor the Extend sensor. It may be caused by: <ul style="list-style-type: none"> <li>Sensor is damaged or location needs to be adjusted</li> <li>Mechanical obstruction</li> <li>Inspect for other reasons the sensor may not be working</li> </ul>                            |
| AutoDeck Error010             | No board after initialize  | Auto Deck Lumber sensor did not trip after chains ran during initialization. Replace sensor.  |
| AutoDeck Error011             | No board after stage   | Check operation of Auto Deck Lumber sensor.   |
| AutoDeck Error013             | Time out during load   | Check operation of Auto Deck Lumber sensor.   |
| AutoDeck Error014             | Command other than initialize received                             | Clear errors and restart the cutting process.   |



**Table A-4: Errors in Software**

| Error Code                   | Text on Screen  | Definition or Solution  |
|------------------------------|---|---|
| AutoDeck Error015            | Command other than stage received   | Clear errors and restart the cutting process.   |
| CalError General001          | No Air Pressure   | Check air supply to saw, air regulator setting, and pressure switch setting. Clean pneumatic filter.  |
| CalError General002          | Saw Not Retracted   | Stroke Home sensor is not sensing that the stroke completely retracted. Inspect the Stroke Home sensor for: <ul style="list-style-type: none"> <li>• Damage or location needs to be adjusted</li> <li>• Mechanical obstruction</li> <li>• The need to reset home offset and calibrate the stroke</li> </ul> |
| CrookedLumberSensor Error002 | Unsteady output   | Check connection to CLS sensor.<br>Check CLS alignment and bracket location.  |
| CrookedLumberSensor Error003 | Out of range  | Calibrate CLS, and check temperature probe.   |
| DGN0001                      | Moving this servo axis while the saw stroke is extended may result in damage to the saw. Do you want to continue?       | Retract the stroke.   |
| DGN0002                      | The saw blade may contact the LASM! Damage to the saw may result. Do you wish to continue?                              | Verify clearance of LASM and move LASM to safe position.  |
| DGN0003                      | The saw motor may contact the LASM because the LASM jaw is open! Damage to the saw may result. Do you wish to continue? | Verify clearance of LASM and move LASM to safe position.  |
| ENG0029                      | Maximum number of retries occurred while sending {0} on Com {1} to the printer controller.                              | Check connections at print controller/Moxa converter.   |
| GripperClamp Error002        | Time out clamping   | When clamping on the board, the Gripper Unclamped sensor is not <b>uncovered</b> after 2 seconds. Check board feeding and gripper mechanics.  |
| GripperClamp Error003        | Time out unclamping   | When unclamping, the Gripper Unclamped sensor is not <b>covered</b> after 2 seconds. Check board feeding and gripper mechanics.   |

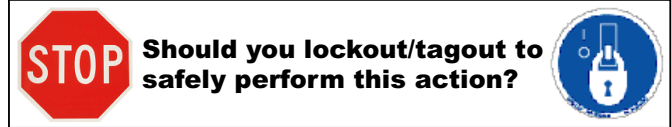

**Table A-4: Errors in Software**

| Error Code            | Text on Screen  | Definition or Solution   |
|-----------------------|---|--|
| GripperClamp Error004 | <p>The board is not against the gripper face. Before selecting <i>Retry</i>, the board must be against the gripper face. Perform the following steps before executing <i>Retry</i>:</p> <ol style="list-style-type: none"> <li>1. Switch to Manual mode</li> <li>2. On the status bar select Clamps - Unclamp All</li> <li>3. Push the board back against the gripper</li> <li>4. Switch to Auto mode</li> <li>5. Select <i>Retry</i></li> </ol>  | <p>Follow instructions in message. If problem happens frequently, observe the load process to determine where the issue is.</p>  |
| InfeedRail Error002   | <p>The board in the machine is too short. Select <i>Continue</i> to continue cutting or <i>Stop</i> to end the cutting process.</p>   | <p>Check the board is the required length. If so, calibrate the gripper.</p>   |
| InfeedRail Error003   | <p>No board was detected during the measuring process.</p>  | <p>Verify that the correct length board was loaded. If so, observe the loading process to determine the loading issue.</p>   |
| InfeedRail Error004   | <p>The end of the board uncovered the board beam sensor at a different location than the stored position. This most likely means the gripper servo axis is out of calibration. Click <i>Ignore</i> to ignore this message or <i>Stop Cutting</i> to end the cutting process at the end of the current board. Stopping the cutting process will reset the stored position to the new position. It is recommended that the cutting in process be stopped and the gripper Home Position calibration be checked by using:<br/><i>Tools&gt;Calibration&gt;Gripper.</i></p> | <p>To reset the EngSawConstants.GripperStoredCalibrationCheckCount to an initialized value of -1, <u>one</u> of the following operations needs to happen:</p> <ul style="list-style-type: none"> <li>• Click the STOP button on the error message.</li> <li>• Calibrate Gripper Home Offset</li> <li>• Calibrate Gripper Home Offset and Counts Per Inch calibration</li> <li>• Calibrate All Home Position</li> </ul> <p>Once the stored value is set to -1, the next time the end of the board uncovers the thru-beam sensor while cutting, the saw computer will set this position as the new stored value.</p> |



**Table A-4: Errors in Software**

| Error Code         | Text on Screen   | Definition or Solution   |
|--------------------|--|--|
| LasmClamp Error002 | Timed out clamping   | Check air supply to saw, air regulator setting, and pressure switch setting. Clean pneumatic filter.<br>LASM Unclamped sensor is damaged or location needs to be adjusted<br>Check for mechanical obstruction. |
| LasmClamp Error003 | Timed out unclamping   | When clamping on the board, the Gripper Unclamped sensor is not uncovered after 2 seconds. Check board feeding and gripper mechanics.  |
| LasmClamp Error004 | Unexpected full clamp  | The LASM clamped all the way closed when it was expected to clamp onto lumber. Determine why board is not feeding into saw chamber properly.   |
| LoadArmError 002   | Timeout moving up while on down sensor                                 | The load arms have been told to move up, but they never came off the Load Arm Down sensor. Check signal to air cylinders and couplings to load arms.   |
| LoadArmError 003   | Timeout moving up  | The load arms never saw the up sensor while being told to lift, but did come off the Load Arm Down sensor. Check that the up sensor is working and no jam has occurred.  |
| LoadArmError 004   | Timeout moving down while on up sensor                                 | The load arms have been told to move down, but they never came off the Load Arm Up sensor. Check signal to air cylinders and couplings to load arms.   |
| LoadArmError 005   | Timeout moving down  | The load arms never saw the down sensor while being told to drop but did come off the Load Arm Up sensor. Check up sensor is working and no jam has occurred.  |
| LoadArm Error006   | Board removed from load arms unexpectedly                              | Board sensor (load arms) sensor is damaged or location needs to be adjusted  |
| Machine Error001   | No air pressure  | Check air supply to saw, air regulator setting, and pressure switch setting. Clean pneumatic filter.   |
| MachineError 002   | Saw stroke is not retracted (not on the home sensor)                   | Follow on-screen instructions. The stroke is not retracted when the machine requires it to be.   |
| MachineError 008   | The infeed board through beam sensor is blocked after clearing the saw | The board beam sensor located by the print heads is blocked when it should not be, indicating there is either an obstruction or an issue with the sensor, cabling, or PLC.                                     |
| MachineError 010   | The bevel is not square before the saw stroke                          | The bevel is required to be square before the saw strokes unless the PC allows it not to be. The home sensor is used to know if the bevel is generally square.   |
| MachineError 011   | The saw blade not running at velocity                                  | The saw blade is either not running or running at a velocity lower than it should be.  |





**Table A-4: Errors in Software**

| Error Code       | Text on Screen  | Definition or Solution   |
|------------------|---|--|
| MachineError 014 | The stroke is not on the home sensor after a Home System was performed. If the stroke does not currently have an error, it is most likely that the stroke home offset is incorrect. | To reset the stroke home offset go to <i>Diagnostics&gt;Detailed Diagnostics&gt;Stroke</i> and click the Home Offset RESET button. Follow the on-screen instructions.  |
| MachineError 015 | The bevel is not on the home sensor after a Home System was performed. If the bevel does not currently have an error, it is most likely that the bevel home offset is incorrect.    | To reset the bevel home offset go to <i>Diagnostics&gt;Detailed Diagnostics&gt;Bevel</i> and click the Home Offset - Reset button. Follow the on-screen instructions.<br><br>The bevel is required to be square after homing. The home sensor is used to know if the bevel is generally square. This is a basic calibration check. |
| MachineError 016 | The LASM lockout sensor was unexpectedly covered during a saw extend  | There is a sensor that is centered on the saw blade that the LASM will trip if the LASM position is plus or minus about 4 inches. If this sensor is tripped and the software has not allowed it to be tripped, this error will show.   |
| Outfeed Error002 | Time out clamping   | Check air supply to saw, air regulator setting, and pressure switch setting. Clean pneumatic filter.<br><br>Outfeed Unclamped sensor is damaged or location needs to be adjusted   |
| OutfeedError 003 | Timed out unclamping  | When unclamping, the Outfeed Unclamped sensor is not covered after 2 second. Check that cylinder is not jammed and is receiving signal to relay.   |
| OutfeedError 004 | Unexpected full clamp   | The outfeed clamp clamped all the way closed when it was expected to clamp onto lumber. Determine why board is not exiting saw chamber properly.   |
| Outfeed Error005 | Timed out running until empty   | Outfeed Unclamped sensor is damaged or location needs to be adjusted<br><br>Inspect outfeed chain for wear   |
| PMG0005          | The machine is not in an appropriate state for cutting.   | If the servos are not ready or the machine is not in the ready homed state when trying to start cutting.   |
| PMG0006          | The saw stroke will not be executed because the blade will intersect with the LASM.   | The software generates this error when calculating the data before sending the data to the PLC.  |
| PMG0010          | The rip bevel angle specified is out of range.<br>Rip Angle = {0}<br>Valid range = 0 - 56.  | The software generates this error when calculating the data before sending the data to the PLC.  |



**Table A-4: Errors in Software**

| Error Code         | Text on Screen  | Definition or Solution   |
|--------------------|---|--|
| SawBlade Error2310 | Output current exceeds trip limit.  | The saw motor is using more current than it should. The saw blade is binding or the power cable is shorting.   |
| SawBlade Error4110 | Control board temperature is above 88°C.  | The VFD control board temperature is too high.   |
| SawBlade Error4210 | Drive IGBT temperature is excessive   | The VFD motor drive circuitry temperature is too high. The saw motor may be experiencing high loads such as a dull saw blade.                              |
| SawBlade Error4290 | Converter module temperature is excessive.  | The VFD motor drive circuitry temperature is too high.   |
| SawBlade Error7112 | Brake resistor overload   | The saw blade braking resistor is being overloaded. The deceleration parameters may be set incorrectly.  |
| ServoError 05B     | Drive disabled, axis motion not possible. The servo may be encountering an obstruction.<br><br>If this servo is contacting the stop at either end of travel, calibrate the Home Offset for this specific servo only using <i>Tools&gt;Calibrate&gt;[this servo]&gt;Home Position.</i>                             | Check for obstructions.<br>Calibrate axis  |
| ServoError 0D1     | Over current condition  | Check for obstructions.<br>Calibrate axis  |
| ServoError 264     | Position was no longer valid (Position Valid axis status bit is off). The servo may be encountering an obstruction.<br><br>If this servo is contacting the stop at either end of travel, calibrate the Home Offset for this specific servo only using <i>Tools&gt;Calibrate&gt;[this servo]&gt;Home Position.</i> | Check for obstructions.<br>Calibrate axis  |
| ServoError 300     | Timeout while waiting for power feedback from the amplifier   | Check safety modules.  |
| SideClamp Error002 | Timed out clamping  | When clamping on the board the Side Clamp Unclamped sensor is not uncovered after 2 second. Check cylinder is not jammed and is receiving signal to relay. |

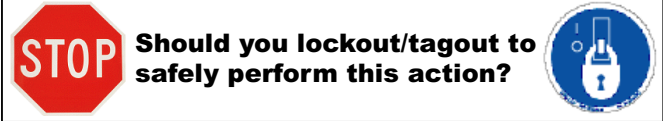

**Table A-4: Errors in Software**

| Error Code         | Text on Screen   | Definition or Solution   |
|--------------------|--|--|
| SideClamp Error003 | Timed out unclamping   | When unclamping the Side Clamp Unclamped sensor is not covered after 2 seconds. Check that cylinder is not jammed and is receiving signal to relay.                              |
| SideClamp Error004 | Unexpected full clamp  | Side Clamp Fully Clamped sensor is damaged or location needs to be adjusted.   |
| SRV0004            | The {0} servo was requested to move to {1} {2} which is out of range.<br><br>The limits are {3} to {4} {2}.<br><br>If the machine is processing parts, the saw cannot process this part. Reject the board with this part and re-start the machine. | Calibrate axis.<br><br>Verify minimum and maximum positions.   |
| SRV0006            | The saw has detected a possible out of calibration situation on the {0} axis. It is recommended to calibrate the {0} home offset using <i>Tools&gt; Calibrate</i> .  | Calibrate axis.  |
| SRV0007            | {0} servo has timed out during a move or cycle.  | Home sensor for indicated axis is damaged or location needs to be adjusted.<br><br>Check for mechanical obstruction.   |
| SRV0011            | {0} servo has encountered an obstruction.<br><br>If this servo is contacting the stop at either end of travel, calibrate the Home Offset for this specific servo only using <i>Tools&gt; Calibrate&gt; [this servo]&gt; Home Position</i>          | Check for mechanical obstruction.<br><br>Calibrate axis.   |
| TopClamp Error002  | Time out moving down   | When moving the clamp down onto the board, the operation didn't complete after 4 seconds. Check cylinder is not jammed and is receiving signal to relay.                         |
| TopClamp Error003  | Time out moving up   | The top clamp took longer than it should have when moving up.  |
| TopClamp Error004  | Lumber sensor blocked when sent to ready   | The board beam sensor located by the print heads is blocked when the 'ready' command is sent. The 'ready' command moves the top clamp down when the board beam sensor is broken. |



**Should you lockout/tagout to safely perform this action?**



**Table A-4: Errors in Software**

| <b>Error Code</b>             | <b>Text on Screen</b>   | <b>Definition or Solution</b>   |
|-------------------------------|---|---|
| TopClamp<br>Error007          | Unexpected full clamp   | The top clamp attempted to clamp a board but no board was present.  |
| OutfeedVFD<br>Error0001       | Output current exceeds trip limit.  | Most likely a physical jam. Clear the obstruction.  |
| OutfeedVFD<br>Error0004       | Short-circuit in motor cable(s) or motor.   | Replace cable and/or motor.   |
| OutfeedVFD<br>Error0012       | Motor is operating in stall region due to e.g. excessive load or insufficient motor power.  | Most likely a physical jam. Clear the obstruction.  |
| OutfeedVFD<br>Error0034       | One of motor phases is lost due to fault in motor, motor cable, thermal relay (if used) or internal fault.  | Repair/replace parts listed as necessary.   |
| OutfeedVFD<br>Error0044       | STO (Safe torque off) requested and it functions correctly.   | An E-stop has been requested and the dual circuit channels opened properly.   |
| OutfeedVFD<br>Error0045       | STO (Safe torque off) input channel 1 has not de-energized, but channel 2 has. Opening contacts on channel 1 might have been damaged or there is a short-circuit. | When an E-stop was initiated, only 1 of the 2 channels opened properly, the circuit that did not open may be shorted or a contact welded. |
| OutfeedVFD<br>Error0046       | STO (Safe torque off) input channel 2 has not de-energized, but channel 1 has. Opening contacts on channel 2 might have been damaged or there is a short-circuit. | When an E-stop was initiated, only 1 of the 2 channels opened properly, the circuit that did not open may be shorted or a contact welded. |
| WasteConv<br>VFDError<br>0001 | Output current exceeds trip limit.  | Most likely a physical jam. Clear the obstruction.  |
| WasteConv<br>VFDError<br>0004 | Short-circuit in motor cable(s) or motor.   | Replace cable and/or motor.   |
| WasteConv<br>VFDError<br>0012 | Motor is operating in stall region due to e.g. excessive load or insufficient motor power.  | Most likely a physical jam. Clear the obstruction.  |



**Should you lockout/tagout to safely perform this action?**



**Table A-4: Errors in Software**

| Error Code                    | Text on Screen  | Definition or Solution  |
|-------------------------------|---|---|
| WasteConv<br>VFDError<br>0034 | One of motor phases is lost due to fault in motor, motor cable, thermal relay (if used) or internal fault.  | Repair/replace parts listed as necessary.   |
| WasteConv<br>VFDError<br>0044 | STO (Safe torque off) requested and it functions correctly.   | An E-stop has been requested and the dual circuit channels opened properly.   |
| WasteConv<br>VFDError<br>0045 | STO (Safe torque off) input channel 1 has not de-energized, but channel 2 has. Opening contacts on channel 1 might have been damaged or there is a short-circuit. | When an E-stop was initiated, only 1 of the 2 channels opened properly, the circuit that did not open may be shorted or a contact welded. |
| WasteConv<br>VFDError<br>0046 | STO (Safe torque off) input channel 2 has not de-energized, but channel 1 has. Opening contacts on channel 2 might have been damaged or there is a short-circuit. | When an E-stop was initiated, only 1 of the 2 channels opened properly, the circuit that did not open may be shorted or a contact welded. |



**Should you lockout/tagout to safely perform this action?**



## Indicators on Specific Electronic Devices

See the *Operation Manual* for indicator lights required for normal operation of the equipment.

### PLC CPU Indicators

Refer to the PLC manufacturer’s manual.



If there is power there will be many LEDs lit throughout the PLC rack. Although the “Power” light located on the left end of the PLC rack may still be lit, full 24 VDC may not be present. If the PLC rack does not have multiple LEDs lit, then a full 24 VDC is not present.

### Ethernet Indicators

**Table A-5: Explanation of Ethernet Indicators**

| LED  | LED State      | CPU Operating State              |
|------|----------------|----------------------------------|
| 100  | On, green      | Network data speed is 100 Mbps   |
|      | Off            | Network data speed is 10 Mbps    |
| LINK | On, green      | The link is physically connected |
|      | Blinking green | Traffic is detected at the port  |

### Amplifier Indicators

The servo amplifier unit detects error conditions and provides alarm information. The indicator lights on the front of the servo amplifier unit communicates the following:

**Table A-6: Explanation of Amplifier Indicators**

| LED             | LED State  | CPU Operating State  |
|-----------------|------------|--|
| POWER           | On, green  | 24 VDC power is present.   |
| DC LINK CHARGED | On, red    | High (motor) voltage DC is present.  |
| LINK            | On, green  | Fiber optic interface is functioning.  |
| ALM             | On, yellow | Alarm condition is detected. When an alarm is detected, power is dropped and the motor is stopped by dynamic braking action. Alarm information is displayed as diagnostic data in the motion controller. |

### E-Stop Module Indicators

Refer to page MT-145.



## Servo Motion Module Indicators

The servo motion module provides communication between the servo axes and the PLC. The indicator lights are defined here.

**Table A-7: Axis Indicators on Servo Motion Module (Model PMM335)**

| LED    | LED State                       | PMM335 Operating State                               |
|--------|---------------------------------|--|
| Axis 1 | On, green                       | The axis drive corresponding to this LED is enabled. |
| Axis 2 | On, red                         | A normal stop error has occurred on this axis.       |
| Axis 3 | Blinking red (500 ms intervals) | A fast stop error has occurred on this axis.         |
| Axis 4 |                                 |  |

**Table A-8: PMM Status Indicators on Servo Motion Module (Model PMM335)**

| LED    | LED State   | PMM335 Operating State  |
|--------|---|---|
| Status | Off   | The module does not have power.   |
|        | On, green   | The module is functioning properly and there are no errors.   |
|        | Blinking green (1 sec intervals)  | Indicates that a Warning or an Error not requiring a stop has occurred.   |
|        | Blinking green (500 ms intervals)   | Indicates that an Error requiring a fast or normal stop has occurred.   |
|        | Blinking green (interval is a pattern) and CONFIG and all axes LEDs are off   | The blink pattern indicates that a fatal error has occurred. Record the number of blinks in the sequence and contact the module's manufacturer's Technical Support. |
|        | Green, blinking simultaneously with the CONFIG and LEDs are off for all axes. | The module is currently loading a firmware upgrade.   |
| Config | On, amber   | A severe module hardware error watchdog timeout has occurred.   |
|        | On, green   | The module has received a valid configuration from the RX3i CPU.  |
|        | Blinking green  | The module has not yet received a configuration from the programmer.  |
|        | On, amber   | The module is in boot mode.   |
|        | Blinking amber  | The module received an invalid configuration from the programmer.   |





**Should you lockout/tagout to safely perform this action?**



**Table A-8: PMM Status Indicators on Servo Motion Module (Model PMM335)**

| LED  | LED State                          | PMM335 Operating State  |
|------|------------------------------------|---|
| FSSB | Off                                | FSSB communications is inactive   |
|      | On, green                          | FSSB communications is active.  |
|      | Blinking green                     | FSSB setup is in progress or servo amplifiers not yet available. Axes can be used with synthetic motor.<br>This is normal operation.          |
|      | On, red                            | FSSB communication link has failed.   |
|      | Off                                | Fiber I/O communications is inactive.   |
| FTB  | On, green                          | Fiber I/O communications is active.   |
|      | Blinking green                     | Fiber I/O configuration is in progress  |
|      | On, red                            | Fiber I/O communication link has failed.  |
|      | Alternately blinking green and red | Indicates an FTB ID error. The module is attempting to communicate with an FTB that does not have the correct PMM/FTB communications link ID. |

## Axis Identification

**Table A-9: Identification Number for Each Axis**

| Axis # | Axis Name |
|--------|-----------|
| 1      | Gripper   |
| 2      | LASM      |
| 3      | Elevation |
| 4      | Stroke    |
| 5      | Angle     |
| 6      | Bevel     |

## Navigating the Parts List Appendix

### Finding the Part Number

The parts list provided here shows spare parts that should be kept in stock at all times. Use one of the methods shown in Table B-1 to locate your part number.

For a complete list of replacement parts, or if you're unsure of which spare part you need and would like to see a picture, use the electronic Parts Guide for this machine. The electronic Parts Guide can be found on our Web site.

**Table B-1: How to Find Your Part Number**



| Using the Spare Parts List in the Manual   | Using Our Web Site: <a href="http://www.mii.com/machinery">www.mii.com/machinery</a>  | Using Your Parts Guide CD-Rom  |
|--|---|--|
| <p>If it is a part that should be kept in stock, it is listed in the Parts List in the manual and in the electronic Parts Guide. Locate the correct part name and description in the manual to find the part number. If you're unsure of which part you need, use the electronic Parts Guide instead to see a picture.</p> | <ol style="list-style-type: none"> <li>1. Click <i>Machinery</i>.</li> <li>2. In the drop-down menu, select <i>Parts Guide</i> to access the Quick Reference Parts Guide.</li> <li>3. Choose your equipment name and browse through the pictured parts to find your part number.</li> </ol> | <ol style="list-style-type: none"> <li>1. Place the CD in your computer's CD drive. It should automatically launch a Main Menu screen.</li> <li>2. If more than one machine shows on the Main Menu, click the machine for which you are ordering parts.</li> <li>3. Browse through the pictured parts to find your part number.</li> </ol> |



### Ordering the Parts With Your Part Number



Call us at 1-800-523-3380 and select *Parts Orders*.

## Safety Notes for Replacing Parts

|   |   |
|---|---|
|   |   |
|  | <p>Only use the exact replacement parts that are specified by MiTek. Substitutions may harm your equipment.</p> |

|   |   |
|---|---|
|   |  <b>WARNING</b>  |
|  | <p><b>ELECTROCUTION, CRUSH, CUT, and HIGH-PRESSURE HAZARDS</b></p> <p>Perform the safety tests described in the <i>Safety Tests</i> section on page MT-11 before operating the equipment at the initial startup, after performing any maintenance, and in accordance with the maintenance schedule.</p> |

|   |   |
|---|---|
|   |  <b>WARNING</b>  |
|  | <p><b>ELECTRICAL HAZARD!</b></p> <p>All electrical work must be performed by a licensed electrician.</p> <p>Follow approved lockout/tagout procedures (OSHA 29 CFR 1910.147).</p> |

|  |  |
|--|--|
|  |  <b>WARNING</b>   |
| <br> | <p><b>ELECTROCUTION AND HIGH PRESSURE HAZARDS.</b></p> <p>Always turn the power off by activating an E-stop when the equipment is not in operation.</p> <p>Always verify that all power to the machine has been turned off and follow approved lockout/tagout safety procedures (OSHA 29 CFR 1910.147) before performing any maintenance on this equipment.</p> <p>Turn off the air switch or shutoff valve if appropriate.</p> <p>Bleed pneumatic lines if appropriate.</p> |

## Part Numbers

### Spare Parts Kit

The spare parts kit is part number 89061-901. For a list of parts included in the spare parts kit, refer to our website. The Keep in Stock column does not indicate it is in the spare parts kit. It is the customer's responsibility to ensure you have these parts.

### Mechanical Parts

Here is a list of mechanical parts that may not be in the online Parts Finder.

**Table B-2: Mechanical Replacement Parts and Sensors**

| <b>MiTek Part #</b>    | <b>Part Description</b>  |
|------------------------|--|
| SB209KIT-A             | linear bearing block for stroke, elevation, and LASM                                   |
| SB209KIT-B             | linear bearing block for gripper, infeed side clamp, top clamp, and outfeed clamp      |
| 337171                 | Spikes (teeth) (set screws) on LASM jaws   |
| 423439                 | sensor, LASM clamp extend & retract  |
| 423448                 | sensor, HSC-12 for outfeed clamp cyl and top clamp cyl                                 |
| 447006                 | bumper, black rubber, LASM and Angle belts   |
| 447007                 | bumper, black rubber, at Angle motor   |
| 447008                 | bumper, black rubber, Elevation  |
| 471339                 | servo motor: LASM, stroke, bevel, gripper, elevation                                   |
| 471340                 | servo motor: angle (has internal brake)  |
| 474173                 | motor for saw blade, 5hp, 3450rpm, 230/460   |
| 503176                 | e-chain on Infeed Rail   |
| 515947                 | prox, 18mm, Home sensor for Gripper, Stroke, Elevation, and LASM (right end of travel) |
| 515948                 | prox, 18mm, LASM at "0" (center of travel)   |
| 515964                 | prox, 8mm HOME SENSOR angle and BEVEL assy   |
| 005-02501              | pulley, used in LASM and stroke drive assemblies                                       |
| SB202KIT               | saw blade replacement kit (includes 1 box of screws)                                   |
| 325184                 | screws for saw blade replacement, qty 50 (does not include saw blade)                  |
| 530030-552.00          | belt, timing, gripper, 552" long (trim to size for any timing belt)                    |
| see online Parts Guide | sensor, CLS w/BLADE program  |
| 508094                 | protective sleeve for blade motor cable  |



## Electrical Parts

Refer to your electrical drawings for part numbers. It is recommended that you keep a variety of extra fuses and sensors in stock.

## Printer & Pneumatic Parts

**Table B-3: Pneumatic and/or Printer Replacement Parts**

| MiTek Part #                | Part Description   |
|-----------------------------|--|
| see <i>Printer</i> appendix | black ink for printer  |
| see <i>Printer</i> appendix | cleaner for printer  |
| 438575                      | filter element for main filter/regulator   |
| 438579                      | service kit for main filter/regulator  |
| 005-00135                   | filter for printer bottles   |
| 809054                      | filter element for touch screen enclosure cooler (located next to main filter/regulator) |
| 809055                      | Rebuild kit w/O-rings for cooler filter  |

## Documentation Part Numbers

**Table B-4: Documentation**

| MiTek Part # | Documentation  |
|--------------|--|
| 001080       | Manual   |
| SB202KIT     | Replacing a saw blade Service Bulletin (includes blade and screws) |
| SB209        | Lubricating linear bearings Service Bulletin                       |
| SB223KIT     | Replacing LASM seals Service Bulletin                              |
| SB181        | Restricted Zone Tape and instructions                              |
| 89550-501    | Operation and safety labels kit, mechanical                        |
| 691290       | Label: 230 Volt  |
| 691351       | Label: Read manual   |
| 691411       | Label: Danger, arc flash   |
| 691507       | Label: Warning, hazardous voltage                                  |
| 691528       | Label: Warning, do not touch, hot                                  |
| 691606       | Label: Caution, not a step   |
| 691701       | Label: Notice, turn off at main panel                              |
| 691821       | Label: MiTek contact information                                   |



### Navigating the Maintenance Checklists



These checklists guide you through all preventive maintenance tasks required to keep this equipment in top working condition.

These pages are supplied with the intent that you will photocopy them and leave the original in the manual for future use. Space is provided in each chart to place the date that the work is done and the initials of the person performing the work.

| Checklist                | Page     |
|--------------------------|----------|
| Daily & Weekly Checklist | page 233 |
| Monthly Checklist        | page 234 |
| Annual Checklist         | page 235 |
| Periodic Checklist       | page 235 |

### Safety Notes For Maintenance Checklists

|   |   |
|---|---|
|   |  <b>WARNING</b>  |
|  | <p><b>ELECTROCUTION, CRUSH, CUT, and HIGH-PRESSURE HAZARDS</b></p> <p>Perform the safety tests described in the <i>Safety Tests</i> section on page MT-11 before operating the equipment at the initial startup, after performing any maintenance, and in accordance with the maintenance schedule.</p> |

|  |   |
|--|---|
|  |  <b>WARNING</b>  |
| <br> | <p><b>ELECTROCUTION AND HIGH PRESSURE HAZARDS.</b></p> <p>Always turn the power off and activate an E-stop when the equipment is not in operation.</p> <p>Always verify that all power to the machine has been turned off and follow approved lockout/tagout safety procedures (OSHA 29 CFR 1910.147) before performing any maintenance on this equipment.</p> <p>Turn off the air switch or shutoff valve if appropriate.</p> <p>Bleed pneumatic and hydraulic lines if appropriate.</p> |

# BLADE Wood Processing System

## Daily & Weekly Checklist

Month and Year:

---

Week:

---

|   |   |
|---|---|
|   | <b>⚠ WARNING</b>  |
|  | <p><b>Lockout/tagout before performing any maintenance!</b></p> <p><b>If power is required, ensure all personnel are clear.</b></p> |

| Action   | Interval | See Page | Dates |  |  |  |  |  |  |
|--|----------|----------|-------|--|--|--|--|--|--|
|  |          |          |       |  |  |  |  |  |  |
| Perform all safety tests.  | Daily    | MT-11    |       |  |  |  |  |  |  |
| Blow off system, including Auto Deck, Infeed Rail, lumber exit chain, and outfeed table/conveyor | Daily    | MT-68    |       |  |  |  |  |  |  |
| Vacuum stroke/elev. chamber  | Daily    | MT-68    |       |  |  |  |  |  |  |
| Clean printer nozzles  | 2x/Day   | MT-69    |       |  |  |  |  |  |  |
| Inspect linear guide bearing rails for grease  | Weekly   | MT-89    |       |  |  |  |  |  |  |
| Replace saw blade  | Weekly   | MT-99    |       |  |  |  |  |  |  |

**Notes**

**Date**

---



---



---



---



# BLADE Wood Processing System

## Monthly Checklist

Year: \_\_\_\_\_

|   |  |
|---|--|
|  | <b>⚠ WARNING</b>   |
|   | <b>Lockout/tagout before performing any maintenance!</b><br><b>If power is required, ensure all personnel are clear.</b> |

| Action  | Interval | See Page | JAN | FEB | MAR | APRIL | MAY | JUNE |
|---|----------|----------|-----|-----|-----|-------|-----|------|
|   |          |          |     |     |     |       |     |      |
| Check lumber exit chain tension and alignment     | 1 month  | MT-117   |     |     |     |       |     |      |
| Grease 2 fittings on elevation jack screw         | 3 months | MT-96    |     |     |     |       |     |      |
| Check oil level in all gearboxes                  | 3 months | MT-73    |     |     |     |       |     |      |
| Powered Skewed Conv. drive wheel bearings: grease | 6 months | MT-131   |     |     |     |       |     |      |
| Replace main regulator's filter element           | 6 months | MT-135   |     |     |     |       |     |      |
| Replace cooler's filter element                   | 6 months | MT-136   |     |     |     |       |     |      |

| Action  | Interval | See Page | JULY | AUG | SEP | OCT | NOV | DEC |
|---|----------|----------|------|-----|-----|-----|-----|-----|
|   |          |          |      |     |     |     |     |     |
| Check lumber exit chain tension and alignment     | 1 month  | MT-117   |      |     |     |     |     |     |
| Grease 2 fittings on elevation jack screw         | 3 months | MT-96    |      |     |     |     |     |     |
| Check oil level in all gearboxes                  | 3 months | MT-73    |      |     |     |     |     |     |
| Powered Skewed Conv. drive wheel bearings: grease | 6 months | MT-131   |      |     |     |     |     |     |
| Replace main regulator's filter element           | 6 months | MT-135   |      |     |     |     |     |     |
| Replace cooler's filter element                   | 6 months | MT-136   |      |     |     |     |     |     |

# BLADE Wood Processing System

## Annual Checklist

Year: \_\_\_\_\_

|   |  |
|---|--|
|  | <b>⚠ WARNING</b>   |
|   | <b>Lockout/tagout before performing any maintenance!<br/>If power is required, ensure all personnel are clear.</b> |

| Action   | Interval | See Page | Sign and Date When Action is Performed |  |  |
|--|----------|----------|--|--|--|
| Lubricate 2 grease fittings on saw blade assy      | 1x/year  | MT-96    |  |  |  |
| Auto Deck motor/gearbox: grease                    | 1x/year  | MT-107   |  |  |  |
| Auto Deck drive shaft: grease 1 fitting per strand | 1x/year  | MT-107   |  |  |  |
| Lubricate outfeed clamp camfollowers               | 1x/year  | MT-115   |  |  |  |
| Lumber exit chain drive gear motor: grease         | 1x/year  | MT-117   |  |  |  |
| Waste conveyor drive bearings: grease              | 1x/year  | MT-124   |  |  |  |
| Inspection   | 1x/year  | MT-71    |  |  |  |

## Periodic Checklist

Year: \_\_\_\_\_

| Action  | Working Hours or Time Interval           | See Page | Sign and Date When Action is Performed |  |  |
|---|--|----------|--|--|--|
| Auto Deck motor/gearbox: replace oil            | Standard oil:<br>10,000 hrs or<br>2 yrs  | MT-72    |  |  |  |
| Lumber exit chain drive gear motor: replace oil |  | MT-72    |  |  |  |
| Waste conveyor gear motor: replace oil          | Synthetic oil:<br>20,000 hrs or<br>4 yrs | MT-72    |  |  |  |
| Saw blade motor: replace oil                    |  | MT-72    |  |  |  |
| Nabtesco gearbox: replace oil                   | 20,000 hrs                               | MT-76    |  |  |  |

**Drawings are inserted at the back of the manual or in a separate binder.**

**Table D-1: Attached Drawings**

| Description                              | Drawing Number |
|--|----------------|
| Blade saw assembly, top level (saw only) | 89060-501      |
| Mechanical assy, top-level (saw only)    | 89061-501      |
| Auto Deck                                | no drawing     |
| Guards and safety devices                | 89100-501      |
| Frame assy                               | 89120-501      |
| CLS assy                                 | 89155-501      |
| LASM assy                                | 89160-501      |
| Lumber exit chain drive                  | 89170-501      |
| Outfeed clamp assy                       | 89640-501      |
| Waste conveyor assy                      | 89195-501      |
| Infeed Rail assy                         | 89200-501      |
| Gripper assy                             | 89280-501      |
| Top and side clamp assy                  | 89300-501      |
| Pneumatic assy                           | 89346-501      |
| Saw blade head assy                      | 89430-501      |
| Stroke and elevation assy                | 89435-501      |
| Printer schematic                        | 89448-xxx      |
| Printer assy                             | 89460-xxx      |
| Lumber exit ramp assy                    | 89465-501      |
| Outfeed table                            | 89490-501      |
| Electrical assy, top-level               | 90615-501      |
| Main enclosure assy                      | 90615-502      |
| Auto Deck electrical                     | 90626          |
| Operator interface assy                  | 90615-507      |

# Glossary

|                                     |   |
|-------------------------------------|---|
| <b>actuate</b>                      | to activate, put into action  |
| <b>affected employee</b>            | an employee whose job requires him/her to operate or use a machine or equipment on which servicing or maintenance is being performed under lockout or tagout, or whose job requires him/her to work in an area in which such servicing or maintenance is being performed                    |
| <b>amperage</b>                     | the strength of an electric current, expressed in amperes   |
| <b>authorized employee</b>          | a person who locks out or tags out a machine or equipment in order to perform servicing or maintenance on that machine or equipment; an affected employee becomes an authorized employee when that employee's duties include performing servicing or maintenance covered under this section |
| <b>Auto Deck</b>                    | a staging conveyor that feeds lumber to the Infeed Rail   |
| <b>Auto Mode</b>                    | the normal operation mode when the saw is using job files to cut the lumber in the correct order  |
| <b>automated lumber feed system</b> | mechanical system used to feed lumber to the Infeed Rail; can be the Auto Deck staging conveyor or an automated lumber retrieval system   |
| <b>axis</b>                         | a main line of direction, motion, growth, or extension; includes angle, bevel, elevation, and stroke; plural is <i>axes</i>   |
| <b>bevel</b>                        | the cut on the 4" dimension of a 2x4, is an optional feature  |
| <b>board</b>                        | A specific piece of lumber with specific dimensions required by the saw to cut out specific parts   |
| <b>bow</b>                          | a curve of the face of a board (3-1/2" surface on a 2x4); the bow points to the side on floor and wall studs  |

# Glossary

|                                |   |
|--------------------------------|---|
| <b>bumper</b>                  | a small, black rubber shock resistor used throughout the interior of the saw  |
| <b>bus bar</b>                 | an electrical device that allows multiple gantry heads to be used simultaneously  |
| <b>CLS</b>                     | Crooked Lumber Sensor; senses when a piece of lumber is crooked and adjust the cut to compensate  |
| <b>connector plate</b>         | a metal plate with “teeth” that hold truss or wall components together  |
| <b>crown</b>                   | a curve of the edge of a board (1-1/2” edge on a 2x4); the crown points up for floor studs or out for wall studs  |
| <b>disconnect</b>              | noun, the handle, often on a machine’s main electrical enclosure, that shuts off incoming power at that spot in the electrical system   |
| <b>elevation</b>               | the assembly that moves the saw blade up and down   |
| <b>energized</b>               | connected to an energy source or containing residual or stored energy   |
| <b>energy isolating device</b> | a mechanical device that physically prevents the transmission or release of energy, including but not limited to the following: manually operated electrical circuit breaker; a disconnect switch; a manually operated switch by which the conductors of a circuit can be disconnected from all ungrounded supply conductors, and in addition, no circuit can be operated independently; a line valve; a block; and any similar device used to block or isolate energy—push buttons, selector switches, and other control circuit type devices are not energy isolating devices |
| <b>energy source</b>           | any source of electrical, mechanical, hydraulic, pneumatic, chemical, thermal, or other energy  |

# Glossary

|                          |  |
|--------------------------|--|
| <b>felt strip</b>        | an anti-friction border on the metal plate that the stroke joins with inside the stroke-elevation chamber                                  |
| <b>foot switch</b>       | an operating device on the Auto Deck staging conveyor  |
| <b>gas spring</b>        | the mechanism that hold the saw chamber door open  |
| <b>gripper</b>           | the component on the Infeed Rail that holds the end of the board and pushes it into the saw chamber  |
| <b>hold-down</b>         | now called the top clamp; located on infeed side of saw  |
| <b>home</b>              | the default location of a component, the act of “homing” a component means to send it to it’s home position                                |
| <b>infeed gripper</b>    | see gripper  |
| <b>job</b>               | A group of parts requiring specific boards to cut it efficiently   |
| <b>illuminate</b>        | to light up, to turn on a light, to glow   |
| <b>Infeed Rail</b>       | the rail that lumber rests on before entering the saw chamber  |
| <b>infeed side clamp</b> | see <i>side clamp</i>  |
| <b>inventory</b>         | in the saw software, inventory is the lumber entered into the software that is available to assign parts to in a job                       |
| <b>jigging</b>           | any of several devices used to hold something; typically describes holding the truss in place on assembly tables                           |
| <b>job</b>               | A group of parts requiring specific boards to cut it efficiently   |
| <b>LASM</b>              | Lumber Advance Short Move; grabs the board as it enters the saw chamber, and moves it to the outfeed side of the saw chamber, if necessary |

# Glossary

|                            |  |
|----------------------------|--|
| <b>LASM lockout sensor</b> | sensor that prevents collisions between the LASM and the saw blade   |
| <b>layout</b>              | a scaled diagram of the location of components and the space that they occupy  |
| <b>leveling screws</b>     | used to refer to any structural leg that can be adjusted up or down by a screwing motion   |
| <b>limit switch</b>        | an electro-mechanical device that consists of an actuator mechanically linked to a set of contacts; when an object comes into contact with the actuator, the device operates the contacts to make or break an electrical connection  |
| <b>load arms</b>           | arms that load lumber from the lumber feed system (Auto Deck or) to the Infeed Rail  |
| <b>lockout device</b>      | a device that utilizes a positive means such as a lock, either key or combination type, to hold an energy isolating device in the safe position and prevent the energizing of a machine or equipment, including blank flanges and bolted slip blinds; should be standardized within the facility in at least one of the following criteria: color; shape; or size; and additionally, in the case of tagout devices, print and format shall be standardized |
| <b>lockout/tagout</b>      | a means of isolating a piece of equipment from its energy source so maintenance can safely occur; guidelines provided in OSHA 29 CFR 1910.147  |
| <b>lumber</b>              | A group of boards or a non-specific board; no consideration given to the final size or shape   |
| <b>lumber exit chain</b>   | outfeed chain, part of the outfeed assembly  |
| <b>lumber feed system</b>  | any system that feeds lumber to the Infeed Rail; usually the Auto Deck staging conveyor or an automated lumber retrieval system  |
| <b>lumber pusher</b>       | on Auto Deck, pushed the lumber onto the Infeed Rail   |



# Glossary

|   |   |
|---|---|
| <b>Lumber Yard</b>                                      | The virtual lumber yard in the saw software that lists lumber available to use and allows the operator to assign each board in a job to a specific lumber in the virtual inventory. |
| <b>Manual Mode</b>                                      | the mode the saw is in when operating it from the Diagnostics screen  |
| <b>master printer enclosure</b>                         | the enclosure that powers the first printer in the system (included in saw purchase)  |
| <b>Miser</b>  | a linear saw created by The Koskovich Company and sold by MiTek   |
| <b>operator control interface or operator interface</b> | the physical components and methods in which the operator controls the machine; for this equipment, it is a touch screen and panel of mechanical buttons                            |
| <b>operator interface panel</b>                         | a group of controls located on the operator interface, to the right of the touch screen   |
| <b>outfeed assembly</b>                                 | the entire area between the saw chamber and the outfeed table or conveyor; includes the lumber exit chain and outfeed clamp   |
| <b>panel</b>  | may refer to an electrical enclosure or a group of controls, such as the operator interface panel located on the touch screen enclosure   |
| <b>part</b>   | A piece of a board, cut to the exact size and shape required for the job  |
| <b>PC</b>   | personal computer   |
| <b>plate</b>  | see <i>connector plate</i>  |
| <b>PLC</b>  | Programmable Logic Controller; a solid-state control device that can be programmed to control process or machine operations.  |

# Glossary

|                                |   |
|--------------------------------|---|
| <b>port</b>                    | a connection point for a peripheral device  |
| <b>potentiometer</b>           | a control knob that is a dial; allows a range of values to be set by turning the dial, also called <i>pot switch</i>  |
| <b>Powered Skewed Conveyor</b> | an optional outfeed conveyor that integrates with the system to transport and sort the lumber   |
| <b>proximity switch</b>        | a switch that uses an electromagnetic field to detect when an object is near, there is no physical contact between the object and the switch; inductive proximity switches detect only metal objects, capacitive proximity switches can sense both metallic and non-metallic objects  |
| <b>qualified person</b>        | a person or persons who, by possession of a recognized degree or certificate of professional training, or who, by extensive knowledge, training, or experience, has successfully demonstrated the ability to solve problems relating to the subject matter and work—ANSI B30.2-1983; one who has skills and knowledge related to the construction and operation of the electrical equipment and installations and has received safety training on the hazards involved—NEC2002 Handbook |
| <b>regulator</b>               | a component of the pneumatic system that connects to the main air source and regulates the air pressure allowed into the system   |
| <b>side clamp</b>              | roller clamp on infeed side of saw that contacts the face of the lumber   |
| <b>solenoid</b>                | an assembly used as a switch consisting of a coil and a metal core free to slide along the coil axis under the influence of the magnetic field  |
| <b>station</b>                 | a physical location on an automatic lumber feed system  |
| <b>stroke</b>                  | the assembly that moves the saw blade in and out (toward or away from operator)   |

# Glossary

|                               |   |
|-------------------------------|---|
| <b>tagout device</b>          | a prominent warning device, such as a tag and a means of attachment, which can be securely fastened to an energy isolating device in accordance with an established procedure, to indicate that the energy isolating device and the equipment being controlled may not be operated until the tagout device is removed; should be standardized within the facility in at least one of the following criteria: color; shape; or size; and additionally, in the case of tagout devices, print and format shall be standardized |
| <b>top clamp</b>              | roller clamp on infeed side of saw that contacts the top edge of the lumber; has been called a hold-down  |
| <b>torque</b>                 | a turning or twisting force   |
| <b>touch screen monitor</b>   | a computer monitor that operates from human touch   |
| <b>VFD</b>                    | Variable Frequency Device; controls the speed of the cycle  |
| <b>voltage</b>                | Equal to the difference of electric potential between two point on a conducting wire carrying a constant current of one ampere when the power between the points is one watt  |
| <b>wane</b>                   | a defect in a board where a portion of the wood is missing from the board edge or face  |
| <b>warp</b>                   | a curve where the face of a board (3-1/2" side on a 2x4); is higher or lower in one spot than on the rest of the board  |
| <b>waste conveyor</b>         | a conveyor under the saw blade that transports waste lumber to a waste receptacle supplied by customer  |
| <b>wood processing system</b> | the entire system including the saw, and all devices that transports lumber to and away from the saw  |

# Index

## Numerics

- 3-phase
  - fuse 167
  - wiring 82

## A

- air knives 142
- amplifier
  - indicators 225
- amplifiers
  - location 144
- angle
  - motor location 74
- Auto Deck
  - graphic 63
  - lubricating shaft 107
  - lumber stops 106
  - raising lumber stops 105
  - sensor locations 195
  - sensors 188
  - sequence of events 105
  - tensioning chain 107
  - troubleshooting 214
- axis number 227

## B

- bearings 72
  - exit chain 116
  - linear guide 89, 90, 91, 92, 93, 94
- belt
  - Powered Skewed Conveyor 131
  - timing belts 84
  - waste conveyor 125, 126, 127
- belts
  - gripper 85, 86, 87
  - length 84
- bevel
  - motor location 74
  - sensors 188, 189
- blade
  - direction of teeth 97
  - lubrication 96

- measuring motion 157
- motor location 74
- overload 165
- replacing 98
- when to replace 97
- blade motor cable 170
- Board Stretcher
  - manual 54
  - software summary 179
- bumpers 101

## C

- calibrating 67
  - crooked lumber sensor 192
- calibration 67
- chains
  - Auto Deck 105, 107
  - lubrication 72
  - lumber exit 114
  - lumber exit chain 116
- checklists 232
- clamps
  - outfeed 114
  - raising 110
  - sensors 188, 189, 198
  - shock absorbers 103
  - top and side 110
- cleaning
  - electrical components 70
  - filter element for cooler 136
  - general 68
  - printer 69
- CLS 192
  - communicating with elevation 194
  - location graphic 197
- computer 177
  - profile 185
- condensation 138
- conveyor
  - Auto Deck 105
  - outfeed 130
  - replacing waste conveyor 128
  - waste 124
- cooler
  - filter element 136

# Index

- maintaining 139
- coupling, tighten 81
- Customer Service 54

## D

- disconnect switch
  - fuse 167
- drawing set 52, 237

## E

- electrical
  - checking voltage 203
  - graphic of enclosure 66
  - main enclosure 144
- elevation
  - communicating with CLS 194
  - felt strips 100
  - graphic 64
  - lubrication 96
  - motor location 74
  - sensors
    - safety
    - sensors 189
- elevation pin 101
- errors 216
  - air pressure 140
  - BLADE software 216
- E-stop
  - perimeter safety cable 143
  - pull-cord 142, 143
- E-stop module 145, 162
- ethernet
  - indicators 225
- ethernet switch 186
- eWON
  - connecting 186
  - overview 186
  - resetting 187

## F

- felt strips 100

- filter
  - cooler 136
- filter/regulator
  - graphic 66
  - replacing filter element 135
- fire 28
- fuses 167
  - location 144

## G

- gearboxes 73
- graphics
  - motor locations 74
  - overview 62
  - sensors 195, 196, 197, 198, 199
- grease
  - linear guide bearings
  - volume 90
- gripper
  - adjusting 108
  - belts 85
  - moving manually 87
  - sensor locations 196
  - tension, adjusting 85

## H

- handle in saw chamber 110
- hazardous substances 28
- homing 67

## I

- incline waste conveyor
  - adjusting 127
- indicators
  - amplifier 225
  - E-stop module 145
  - ethernet 225
  - PLC 225
  - servo motion module 226
- infeed
  - adjusting gripper 108

# Index

- motor location 74
- top clamp and side clamp 110
- Infeed Rail
  - sensor locations 195
- inspection 71

## K

- Kepware
  - software summary 179
- Kepware software 181

## L

- LASM 113
  - belt and bearings 113
  - belts 88
  - graphics 113
  - sensor location 198
  - sensors 188
  - spikes 113
  - tension, adjusting 88
- license 179
- load arms
  - adjusting 109
  - sensors 188
- lockout/tagout
  - graphic 53, 57
  - guidelines 5
  - procedure 6, 9, 35, 38
- lubrication
  - Auto Deck shaft 107
  - bearings 72
  - exit chain bearings 116
  - general 72
  - linear guide bearings 89, 90, 91, 92, 93, 94
  - lumber exit chain drive 116
  - motors 75
  - motors and gearboxes 73
  - outfeed clamp 115
  - overview 72
- lumber exit chain
  - adjusting location 117
  - alignment 114

- chain guide brackets 118
- lubrication 116
- tension 117
- lumber stops
  - operating 106
  - raising 105

## M

- maintenance
  - annual 236
  - checklists 232
  - daily and weekly 234
  - inspection 71
  - monthly 235
  - periodic 236
  - safety during 56
- manual
  - how to use 52
  - introduction 50
  - navigation 53
  - part number 52
  - purpose 50
  - understanding formatting 53
- motor
  - coupling or collar 81
  - slippage 78, 79, 80, 81
- motors
  - changing rotation 82
  - checking oil 75
  - location graphic 74
  - oil 75
  - overview 73
- multimeter 203

## N

- networking
  - ethernet
    - switch 186
- notice of change iii

## O

- operator interface

# Index

- computer maintenance 177
  - graphic 62
  - outfeed
    - graphic 65, 66
    - lubrication 116
    - motor location 74
    - outfeed clamp 115, 119
    - overview 114
  - outfeed conveyor
    - adjusting belt 131
    - aligning 130
    - lubricating 130
  - overload
    - braking resistor 165
  - overloads
    - location 144
    - motor starter 164
- P**
- page change iii
  - parts 228
    - documentation part numbers 231
    - electrical part numbers 231
    - mechanical part numbers 230
    - pneumatic part numbers 231
    - safety while replacing 229
  - parts list 228
  - perimeter safety cable 142, 143
  - PLC
    - indicators 225
    - overview
    - software 180
    - software summary 179
  - PLC (programmable logic controller) 155
  - pneumatics
    - adjusting system pressure 137
    - air knives in saw chamber 142
    - components controlled by 134
    - drain 138
    - filter 135
    - maintenance, general 142
    - minimum air pressure 140
    - overview 133
    - pressure, adjusting 137
    - printer system relief valve 141
    - regulator 137, 138
      - regulator 140
      - settings 134
  - Powered Skewed Conveyor
    - adjusting belt 131
    - aligning 130
    - graphic 63
    - lubricating 130
  - pressure switch 140
  - printer
    - raising 110
    - relief valve 141
    - supplies graphic 65
    - troubleshooting 215
  - printing the manual 1
  - profile 185
  - programmable logic controller, *see* PLC
  - pull-cord 142, 143
- R**
- regulator 137
  - relief valve for printer 141
  - reporting errors ii
  - Reports
    - software summary 179
  - restricted zones 17
  - return goods ii
  - rope E-stop 142
- S**
- safety
    - during maintenance 233
    - during troubleshooting 201
    - E-stop module 162
    - hazardous substance 28
    - in Spanish 29
    - indicators 1
    - lockout/tagout 5, 53
    - maintenance 56
    - replacing parts 229
    - restricted zones 17
    - rules 2
    - safety rules 1, 30



# Index

- signal words 1
- test 11
- troubleshooting w/energy 10
- understanding E-stop circuit 145
- safety motion sensor 157
  - location 144
- safety symbols 19
- saw chamber
  - air knives 142
  - graphic 65, 66
- scrap conveyor, *see* waste conveyor
- sensors
  - Auto Deck & Infeed locations 195
  - CLS 192
  - front side location graphic 197
  - front side locations 197
  - gripper locations 196
  - LASM clamped & unclamped 198
  - locations on infeed side of saw 199
  - overview 188, 189
  - sensor gap for prox switches 190
  - stroke & elevation locations 199
  - troubleshooting the basics 190
- servo motion module
  - indicators 226
- shock absorbers 103
- side clamp 110
- Software
  - summary 179
- software
  - BLADE license 180
  - Kepware license 181
  - license 179, 180
  - PLC license 180
  - summary 179
- stroke
  - belts
    - LASM & Stroke 88
  - graphic 64
  - motor location 74
  - sensors 189
- stroke/elevation chamber
  - sensors 199

## T

- take-away conveyor, *see* waste conveyor
- thermostat 139
- top clamps 110
- troubleshooting
  - Auto Deck 214
  - axes identification 227
  - CLS 192
  - errors 216
  - infeed rail 205
  - material handling 214
  - printer 205, 215
  - safety 201
  - saw 205
  - saw, printer, and Infeed Rail 205

## V

- VFD 163
  - location 144
  - powered skewed conveyor 130
  - saw 163

## W

- waste conveyor
  - adjusting 125, 126, 127
  - graphic 66
  - lubricating
  - motor location 74
  - replacing belt 128